

Safety and Disconnect Switches

Industrial Control Product Catalog 2021



General Duty Switch



Heavy Duty Switch



contents

Safety Switch Guide Form Specifications	18/3
Feature Comparison	18/4
Enclosure Types	18/5
Catalog Numbering System	18/6
General Duty Safety Switches	
Plug Fuse Enclosed Type, 120/240V Fusible—Selection	18/7
60A Special Application Type, 240V Non-Fusible—Selection	18/7
General Duty Switches—Features	18/8
240V Fusible and Non-Fusible—Selection	18/9
Heavy Duty Safety Switches	
Heavy Duty Switches—Features	18/10
240V Fusible—Selection	18/11
600V Fusible—Selection	18/12
600V Non-Fusible—Selection	18/13
Type 4/4X and 12 with Viewing Window—Selection	18/14
Special Applications Safety Switches	
Type ECS Elevator Control Switches	18/15 – 18/16
4-Pole and 6-Pole—Selection	18/17
Interlocked Receptacle—Selection	18/18
Non-Metallic—Selection	18/19
Enclosed Solar PV Disconnects	18/20
Accessories—General and Heavy Duty Switches	
Class R Fuse Clips, Class J Fusing, Class T Fuse Adapter Kits	18/21
Neutral Kits, 200% Neutral Kits, Fuse Puller Kits	18/21
Auxiliary Contacts, Copper Lug Kits	18/22
Equipment Ground Kits, Isolated Ground Kits	18/22
Interchangeable Hubs	18/23
Compression Lug, Neutral Barrier Kits, Lugs and Wire Ranges	18/23
Multiple Padlocks, Kirk-Key Interlocks	18/23
Dimensions and Weights	
General and Heavy Duty Switches	18/24 – 18/27
Type 1 and 3R Knockout Diagrams	18/28 – 18/29
Non-Metallic and Receptacle Switch Dimensions	18/30
4-Pole and 6-Pole Switch Dimensions	18/31
Double-Throw Switches	
Selection	18/32 – 18/33
Dimensions	18/34
VBII Safety Switch Replacement Parts	18/35

Safety and Disconnect Switches



contents

3LD Switch Disconnectors

Quick selection guides	18/36 – 18/37
3LD3 main control and EMERGENCY_STOP switches UL508	18/38 – 18/47
3LD2 main control and EMERGENCY_STOP switches UL508	18/48 – 18/67
3LD5 main control and EMERGENCY_STOP switches UL489	18/68 – 18/77
Enclosed Rotary Disconnects	18/78 – 18/79

Type VBII (30-600A)

Features and Ordering Information	18/80
Switch and Handle Selection	18/81
Accessories	18/82 – 18/83
Dimensions and Lug Wire Ranges	18/84

Type MCS (30-200A)

Switches, Fuse, and No Fuse Kit—Selection	18/85
Handle Operators and Accessories	18/86

Type CFS Compact Fusible Switches

General information and catalog numbering system	18/87
Features and ordering information	18/88
Switch, shaft and handle selection	18/89
Selection and accessories	18/90
Technical Characteristics	18/91

Type CNFS Compact Non-Fusible Switches

General information and catalog numbering system	18/92
Features and ordering information	18/93
Switch, shaft and handle selection	18/94
Additional accessories	18/95

	General Duty	Heavy Duty	Double Throw																																							
Application	General Duty Switches are intended for applications where reliable performance and continuity of service are needed, but where duty requirements are not severe and usual service conditions prevail. (These switches are intended for use primarily with supply circuits rated 240V AC or less where the available fault current is less than 100,000A when used with Class R or T fuses or 10,000A max. when used with Class H fuses.)	Heavy Duty Switches are intended for use in applications where: 1. Rugged construction, reliable performance, continuity of service and ease of maintenance are emphasized, or 2. Available fault currents higher than 10,000A are likely to be encountered, such as in manufacturing plants, mass production industries, and commercial, institutional and other large buildings served by network systems or transformers of higher capacities. 3. System voltage is 600V AC or DC Max. 4. A Type 12 or 4 / 4X enclosure is required.	Double throw switches are intended to transfer loads from one power source to another. All 2 & 3 pole double throw switches are suitable for use as service equipment. All are UL Listed. Switches are rated for use on systems with an available fault current of up to 10,000 AIC when protected with Class H fuses or either 100,000 or 200,000 AIC when protected with Class R, J or Class T fuses. They can also be used to connect a single source of power to either of two loads. In this application it is necessary to field modify fusible switches so that the fuses are on the load side of the switching mechanism.																																							
Short Circuit Withstand Ratings	Suitable for use on systems capable of delivering not more than 100,000 RMS symmetrical amperes of fault current as follows: <table border="1"> <thead> <tr> <th>Sw. Rating</th> <th>AIC Rating</th> <th>Protective Device[ⓐ]</th> </tr> </thead> <tbody> <tr> <td>30-600A</td> <td>10,000</td> <td>Circuit Breaker</td> </tr> <tr> <td>30-600A</td> <td>10,000</td> <td>Class H Fuse</td> </tr> <tr> <td>30-600A</td> <td>100,000</td> <td>Class R Fuse</td> </tr> <tr> <td>100-600A</td> <td>100,000</td> <td>Class J or T Fuse</td> </tr> </tbody> </table>	Sw. Rating	AIC Rating	Protective Device [ⓐ]	30-600A	10,000	Circuit Breaker	30-600A	10,000	Class H Fuse	30-600A	100,000	Class R Fuse	100-600A	100,000	Class J or T Fuse	Suitable for use on systems capable of delivering not more than 200,000 RMS symmetrical amperes of fault current as follows: <table border="1"> <thead> <tr> <th>Sw. Rating & Type</th> <th>AIC Rating</th> <th>Protective Device[ⓐ]</th> </tr> </thead> <tbody> <tr> <td>All Heavy Duty & DT</td> <td>10,000</td> <td>Circuit Breaker</td> </tr> <tr> <td>30-600A HD & DT</td> <td>10,000</td> <td>Class H Fuse</td> </tr> <tr> <td>60A Compact HD</td> <td>100,000</td> <td>Class R, J or T Fuse</td> </tr> <tr> <td>GD & 4P DT</td> <td>100,000</td> <td>Class R, J or T Fuse</td> </tr> <tr> <td>30-600A HD</td> <td>200,000</td> <td>Class R, J or T Fuse</td> </tr> <tr> <td>30-600A DTF & DTNF DT[ⓑ]</td> <td>200,000</td> <td>Class R, J or T Fuse</td> </tr> <tr> <td>800 & 1200A HD & DT[ⓑ]</td> <td>200,000</td> <td>Class L or T Fuse</td> </tr> </tbody> </table>	Sw. Rating & Type	AIC Rating	Protective Device [ⓐ]	All Heavy Duty & DT	10,000	Circuit Breaker	30-600A HD & DT	10,000	Class H Fuse	60A Compact HD	100,000	Class R, J or T Fuse	GD & 4P DT	100,000	Class R, J or T Fuse	30-600A HD	200,000	Class R, J or T Fuse	30-600A DTF & DTNF DT [ⓑ]	200,000	Class R, J or T Fuse	800 & 1200A HD & DT [ⓑ]	200,000	Class L or T Fuse	
Sw. Rating	AIC Rating	Protective Device [ⓐ]																																								
30-600A	10,000	Circuit Breaker																																								
30-600A	10,000	Class H Fuse																																								
30-600A	100,000	Class R Fuse																																								
100-600A	100,000	Class J or T Fuse																																								
Sw. Rating & Type	AIC Rating	Protective Device [ⓐ]																																								
All Heavy Duty & DT	10,000	Circuit Breaker																																								
30-600A HD & DT	10,000	Class H Fuse																																								
60A Compact HD	100,000	Class R, J or T Fuse																																								
GD & 4P DT	100,000	Class R, J or T Fuse																																								
30-600A HD	200,000	Class R, J or T Fuse																																								
30-600A DTF & DTNF DT [ⓑ]	200,000	Class R, J or T Fuse																																								
800 & 1200A HD & DT [ⓑ]	200,000	Class L or T Fuse																																								
Fuses	Fusible switches will accept the following UL class fuses: 30 "LF" - 30A max plug Fuses 30-600A "GF" Class H & K, Class R with kit 100-600A "GF" Class J-move base 100-200 "GF" Class T with kit 400-600A "GF" Class T-move bases	Fusible switches will accept the following UL class fuses: 30-600A "HF" Class H & K, Class R with kit 30-400A, 600V "HF" Class J-move base 100-600A, 240V "HF" Class J-move base 100-200A "HF" Class T with kit 400-600A "HF" Class T-move bases 800-1200A "HF" Class L, Class T with kit [ⓑ]	Fusible switches will accept the following UL class fuses: 30-200A "DT" & "F" Class H & K, Class R with kit 30 & 60A 600V "DT" Class J-move base 100-200A "DT" Class J-move base, Class T with kit 400-600A "DT" Class J-standard, Class T-move bases 400A 240v "F" Class H-standard 400A, 600V & 600A "F" Class T-Standard																																							
Cover Interlocks	Voidable – cover interlocks on switches prevent the switch door from being opened when in the "ON" position. No cover interlock on 30-60A GD or on plug fuse type switches.	Voidable dual cover interlocks standard on all heavy duty switches. Prevents cover from being opened when switch is in the "ON" position and prevents switch from being turned "ON" when door is opened.	Dual cover interlocks standard on all double throw switches. Prevents cover from being opened when switch is in the "ON" position and prevents switch from being turned "ON" when door is opened.																																							
Underwriters' Laboratories, Inc.	Listed by UL under file #E4776 as enclosed switches and also suitable for use as service equipment (where applicable). UL98 Enclosed and Deadfront Switches.																																									
NEMA Specifications	Meet NEMA standard KS-1-2001 for type GD switches.	Meet NEMA standard KS-1-2001 for type HD switches.	Meet NEMA standard KS-1-2001 type GD for "DTG" & type HD for "DT", "F" & "NF" switches.																																							
Seismic Qualifications	100-600A GD & all HD switches and "DT" type double throw switches have been tested and comply with the 2010 California Building Code (CBC) and with the 2009 International Building Code (IBC) - Compliance Level SDS = 1.85 g																																									
Groundable Neutral (All neutrals are bondable for service entrance use.)	Fusible switches have groundable neutral blocks factory installed. Non-fusible switches accept field addable neutrals.	All switches (both Fusible and Non-Fusible) are either supplied with factory installed neutrals or accept field addable neutrals.	All except 4 pole switches will accept field addable neutrals except that "DTG" 100 & 200A switches are also available with factory installed neutrals.																																							
Padlocks	Padlockable cover latch. OFF padlock provisions on handle.	Padlockable cover latch and multiple OFF padlock provisions on handle.	Padlockable cover latch and multiple OFF padlock provisions on handle.																																							
HP & Load Break Ratings	All General Duty, Heavy Duty and Double Throw Switches are both load break and horsepower rated.																																									

ⓐ The protective device can either be a fuse installed in a fusible switch or an upstream fuse or circuit breaker protecting a non-fusible switch. The ampere rating of the

upstream protective device must not exceed the switch ampere rating.

ⓑ All 4 pole and fusible double switches with catalog numbers starting with "F" are rated 100,000 AIC max.

ⓐ Class T kit available for 240V max. applications on 1200A switches.

General Duty	Heavy Duty	Double Throw	Features / Ratings
▪	▪	▪	30 thru 600 Amps
	▪	▪	800 and 1200 Amps
▪	▪	▪	240 Volt AC
	▪	▪	600 Volt AC
▪	▪	▪	250 Volt DC
	▪		600 Volt DC
▪	▪	▪	Double-break visible blade design (30-200A)
▪	▪	▪	Quick-make, quick-break switching action (excludes 30A GD)
	▪		Handle design for hook stick operation
▪	▪	▪	Padlockable cover latch
▪	▪	▪	Padlockable handle
▪		▪	Single voidable cover interlock (excludes 30-60A GD)
	▪	▪	Dual voidable cover interlock
▪	▪	▪	Type 1 enclosure
▪	▪	▪	Type 3R enclosure
	▪	▪	Type 12 enclosure
	▪	▪	Type 4 / 4X enclosures
▪	▪	▪	Generous wiring gutters that meet UL and NEC wire-bending space requirements
▪ ^⑤	▪	▪	Lugs suitable for copper or aluminum at 60° or 75°C
▪	▪	▪	CU/AL wire lugs that meet UL 486B requirements
	▪	▪	Suitable for field-convertible compression connectors
▪ ^④	▪	▪	All plated copper current carrying parts (except lugs)
▪	▪	▪	Spring reinforced Fuse Clips (except 30-60A GD) ^②
	▪	▪	Clear pivoting line terminal shield
▪	▪	▪	Replacement parts (except 30-60A GD)
	▪	▪	200% neutral available for purchase separately
▪ ^⑦	▪ ^{①⑦}	▪ ^{①⑦}	Provisions for UL Class T, R and H Fuses
	▪	▪ ^①	Provisions for UL Class J and L Fuses
	▪	▪	Metal nameplate
▪	▪	▪	Aux. switch kits (excludes 30-60A GD)
	▪ ^③		Type 4X with stainless steel interior parts
▪ ^④	▪		Rolled flange enclosure design (30-200A)
	▪	▪	Isolated ground kits

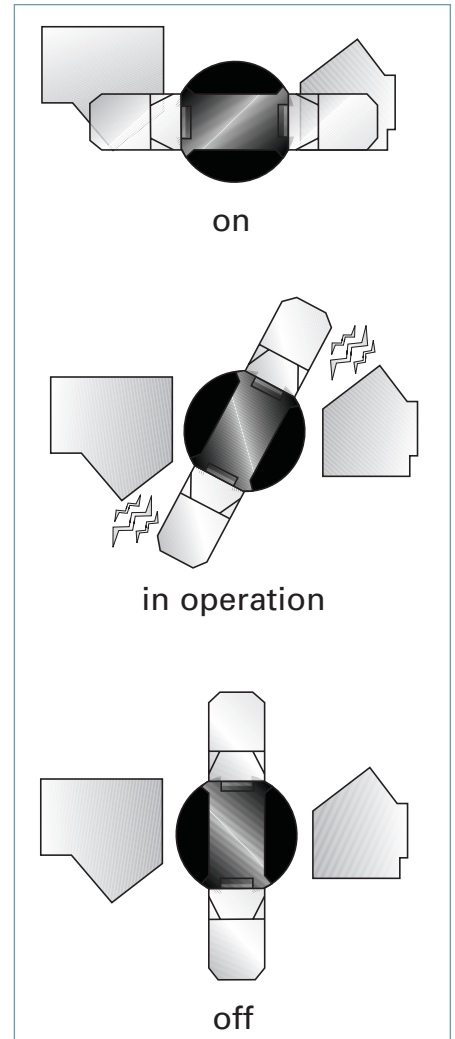

Double Break Switching Action

Like the time-proven Vacu-Break Design, the Siemens VBII double break switching action breaks the arc in two places in 30-600A ratings. This reduces heat generation and increases switching speed by doubling the breaking distance. The result is enhanced performance and increased longevity. We also provide the most visible blade design available today. Unlike conventional knife blade switches, the blades are self-aligning to ensure positive contact. In addition, they have no wear and friction point since the “electrical hinge” has been eliminated. The result is a very fast, positive and reliable switching action for even the most severe applications.

① 400, 600V & 600A fusible, double-throw switches accept only Class J or T fuses. Only 800 & 1200A HD switches will accept Class L fuses.
 ② 30-60A general duty switches have fuse clips constructed of spring type copper.

③ 30-200A Type VBII in stainless steel enclosures.
 ④ 100-200A.
 ⑤ 60A only suitable for Cu at 75°.

⑥ 200A general duty switches have aluminum neutral assemblies.
 ⑦ 100-600A GD & DT and 100-1200A HD switches will accept Class T fuses.

Enclosure Types

- A Type 1** enclosures are intended for indoor use primarily to provide protection against contact with the enclosed equipment in locations where unusual service conditions do not exist.
 - B Type 3R** enclosures are intended for outdoor use primarily to provide a degree of protection against falling rain and sleet and must remain undamaged by the formation of ice on the enclosure. They are not intended to provide protection against conditions such as dust, internal condensation, or internal icing.
 - C Type 4, 4X** enclosures are intended for indoor or outdoor use primarily to provide a degree of protection against windblown dust, rain, splashing water and hose-directed water. They are not intended to provide protection against conditions such as internal condensation or internal icing. Also meets 4X definition by providing a high degree of protection against corrosion. Siemens 30-200A stainless steel 4X switches are supplied stainless interior parts and hardware as standard.
 - D Type 4** enclosures are intended for indoor or outdoor use primarily to provide a degree of protection against windblown dust, rain, splashing water and hose-directed water. They are not intended to provide protection against conditions such as internal condensation or internal icing.
 - E Type 12[Ⓛ]** enclosures are intended for indoor use primarily to provide a degree of protection against dust, falling dirt and dripping water. They are not intended to provide protection against conditions such as internal condensation.
- Type 7/9** enclosures for use in hazardous locations. Use with molded case switches listed in Section 7.



Load Break Ratings

All Siemens safety switches are load break rated. The load break rating is assigned by UL after the switching unit has successfully performed the following tests:

Switch Ampere Rating	Number of ON/OFF Operations per Minute	Number of Operations		
		With Current	Without Current	Total
30-100	6	6000	4000	10000
200	5	6000	2000	8000
400	4	1000	5000	6000
600	3	1000	4000	5000
800	2	500	3000	3500
1200	1	500	2000	2500

Horsepower Ratings

All Siemens safety switches, where appropriate, are horsepower rated. Ratings are approved by UL only after the switching unit has undergone testing to determine its acceptability which includes repeated interruption of the locked rotor current of the motor for which it is to be rated as follows:

Max HP Rating	Number of ON/OFF Operations per minute	Number of Cycles of Operation
100	6	50
500	1	10

Non-Fusible Safety Switch AIC Ratings When Protected by a Circuit Breaker[Ⓛ][Ⓜ]

Breaker Frame	Non-Fused Switch	UL Listed Short Circuit Current Rating
NEG, NGB, ED4	30 DT (240V)	18 kA Thru 240 VAC
NEB, NEG, NGG, NGB, ED4	100A GD & DT (240V)	18 kA Thru 240 VAC
NEB, NEG, NGG, NGB, ED4	30-100A HD & DT (600V)	18 kA Thru 480 VAC
ED6	30-100A HD & DT (600V)	18 kA Thru 600 VAC
FD6-A, JD6-A	200A HD & DT (600V)	18 KA Thru 600 VAC
JD6-A, LD6-A	400A GD & DT (240V)	18 kA Thru 240 VAC
JD6-A, LD6-A	400A HD & DT (600V)	18 kA Thru 600 VAC
LD6-A	600A GD & DT (240V)	25kA Thru 240 VAC
LD6-A	600A HD & DT (600V)	25kA Thru 600 VAC
NNG	1200A HD & DT (600V)	25 kA Thru 600 VAC

[Ⓛ] VBII Type 12 switches are also rated 3R & 3S for outdoor use. Type 3R is defined in B above. 3S rated enclosures provide a degree of protection against windblown dust and allow operation when the enclosure is ice laden.
[Ⓜ] All switches above are rated at 10 KA when protected by any UL Listed CB
[Ⓝ] Circuit breaker trip rating must not exceed switch ampere rating

Safety Switches

Type VBII Safety Switch Catalog Numbering System

Product Overview

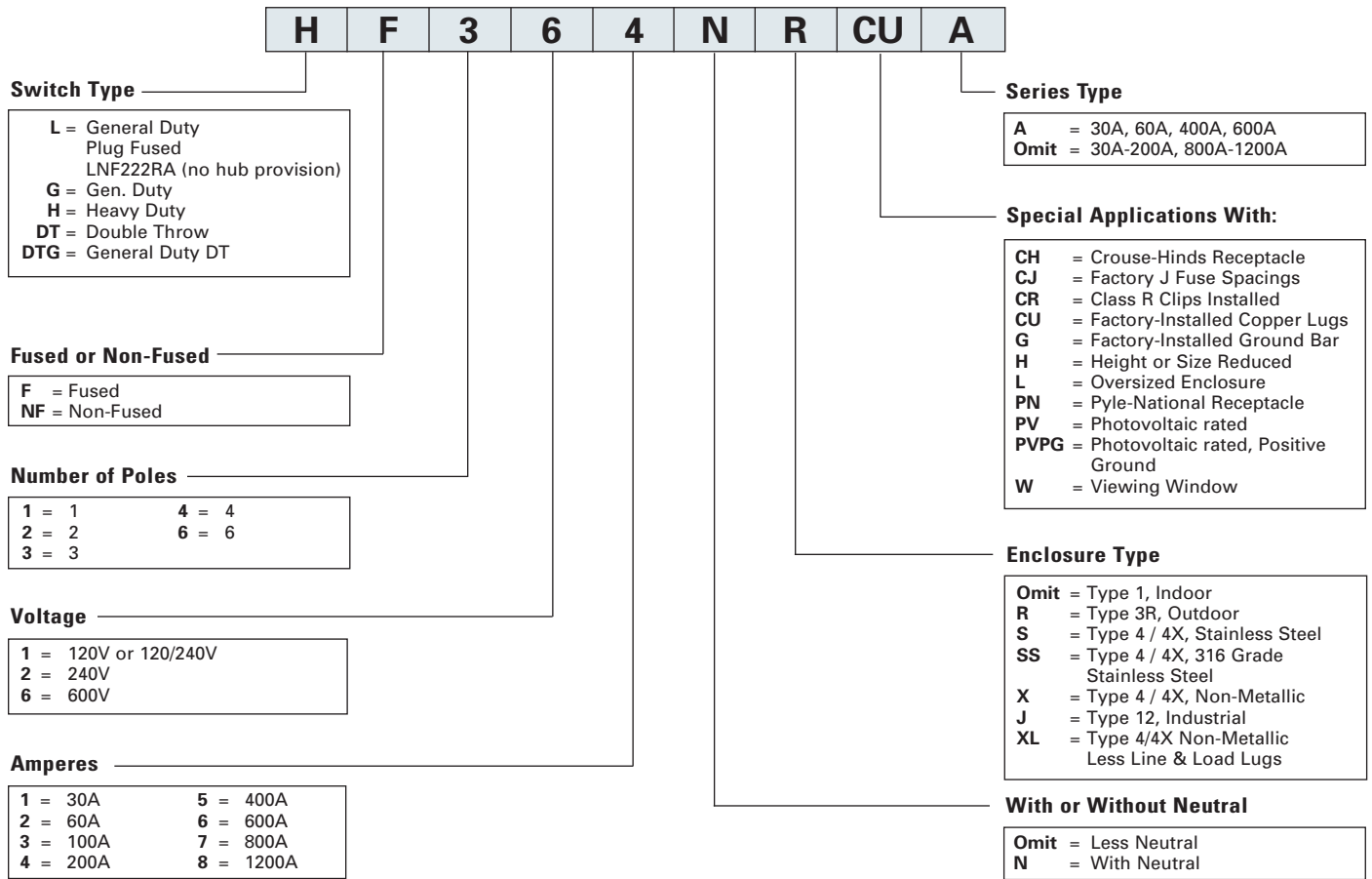

Type VBII Accessories Catalog Numbering System

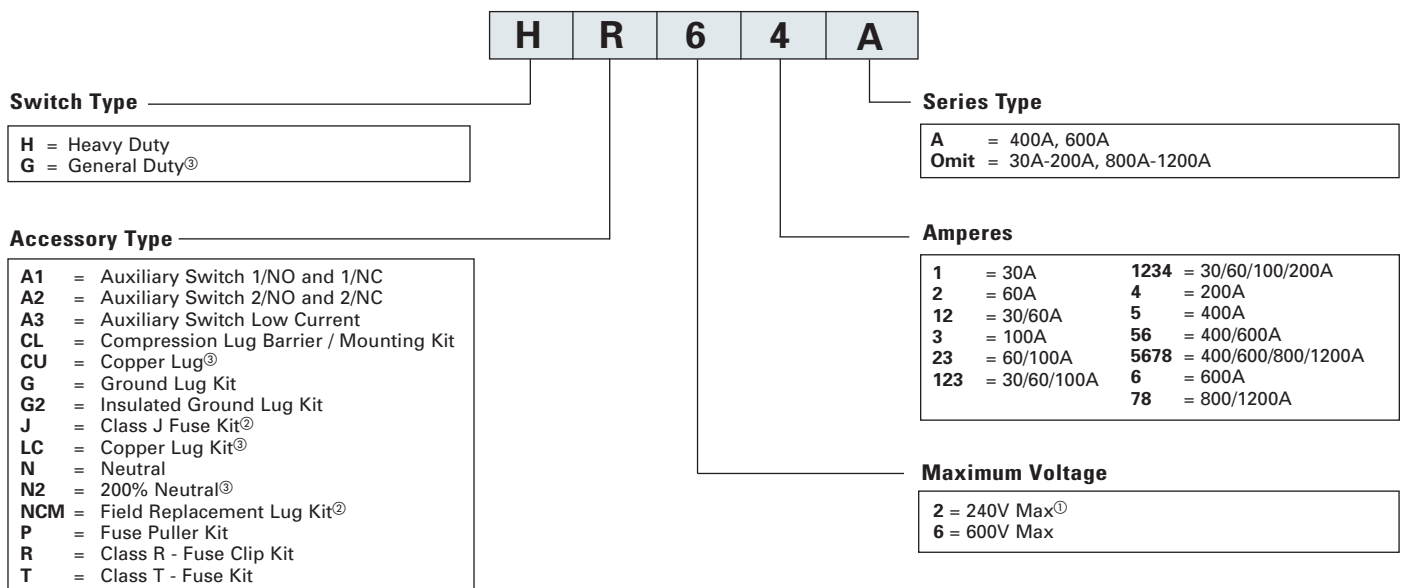

Note: Catalog numbering systems above do not apply to 4-pole & Type "F" & "FR" double throw switches & accessories.

① For 400A, 600A use 680V max accessories except for T Fuse Kit.
 ② Only offered for 400A, 600A.

③ For 30A-200A, 800A-1200A.

Safety Switches

Plug Fuse and 60A Special Application Type

Selection

Features

- Compact size
- Horsepower rated
- Indoor and outdoor enclosures
- Quick make-quick break mechanism
- Visible "ON"-"OFF" indications
- Padlock-off handle feature
- Door padlock provision
- Bondable neutral (where indicated)
- Lugs suitable for copper or aluminum wire
- UL Listed
- Fuses — not included
- Switches accept Edison base plug fuses
- Hubs — see page 18/23
- Lugs — see page 18/23

Dimensions (inches)

Type	Height	Width	Depth
1	8½	5½	3
3R	8½	5½	3½

Wire Range Table

Switch Type	Wire Range
120/240 Volt Fusible 30 Amp	Cu/Al #14 to #8 AWG [®]
240 Volt Non-Fusible 60 Amp	Cu #14 to #6 AWG



Ampere Rating	Indoor — Type 1		Outdoor — Type 3R		Horsepower Ratings [®]	
	Catalog Number	Ship. Wt. (lbs.) Pkg. of 10	Catalog Number	Ship. Wt. (lbs.) Pkg. of 10	Standard	Maximum

120/240 Volt Fusible

1-Pole and Solid Neutral[®]

120 Volt — 1-Phase, 2-Wire

30	LF111N	35	LF111NR	35	½	2
----	--------	----	---------	----	---	---

2-Pole and No Neutral

120/240 Volt — 1-Phase, 2-Wire

30	Use 2-Pole and Solid Neutral				
----	------------------------------	--	--	--	--

2-Pole and Solid Neutral[®]

120/240 Volt — 1-Phase, 3-Wire

30	LF211N	35	LF211NR	35	1½	3
----	--------	----	---------	----	----	---

240 Volt Non-Fusible

2-Pole Special Application Switch

1 or 2-Pole — No Fuse

240 Volt — 1-Phase, 2-Wire

30	—	—	LNF221RLA [®]	30	—	3
30	—	—	LNF221RLLA [®]	38 (pkg. of 5)	—	3
60	—	—	LNF222RA [®]	30	—	10
60	—	—	LNF222RLA [®]	38 (pkg. of 5)	—	10

For inches / millimeters conversion, multiply inches by 25.4.

[®]Dual horsepower ratings:

Std. — applies when non-time delay plug fuses are installed.

Max — applies when time-delay plug fuses are installed.

[®]Has service entrance label.

UL Listed as "Enclosed Switches" (suitable for use as service equipment where indicated) under File #E4776. (NEMA) — Type G.D.

Federal Spec. — W-S-865C — type LD or type NDS

[®]Bottom cable entry and exit only. No hub provision supplied. Ground lug is included and factory installed.

[®]Line lugs will accept and are UL approved for #14 to #6 Cu/Al cable.

[®]PLUS series: Larger enclosure compared to LNF222RA.

[®]MAX series: Larger enclosure compared to LNF221RLA.

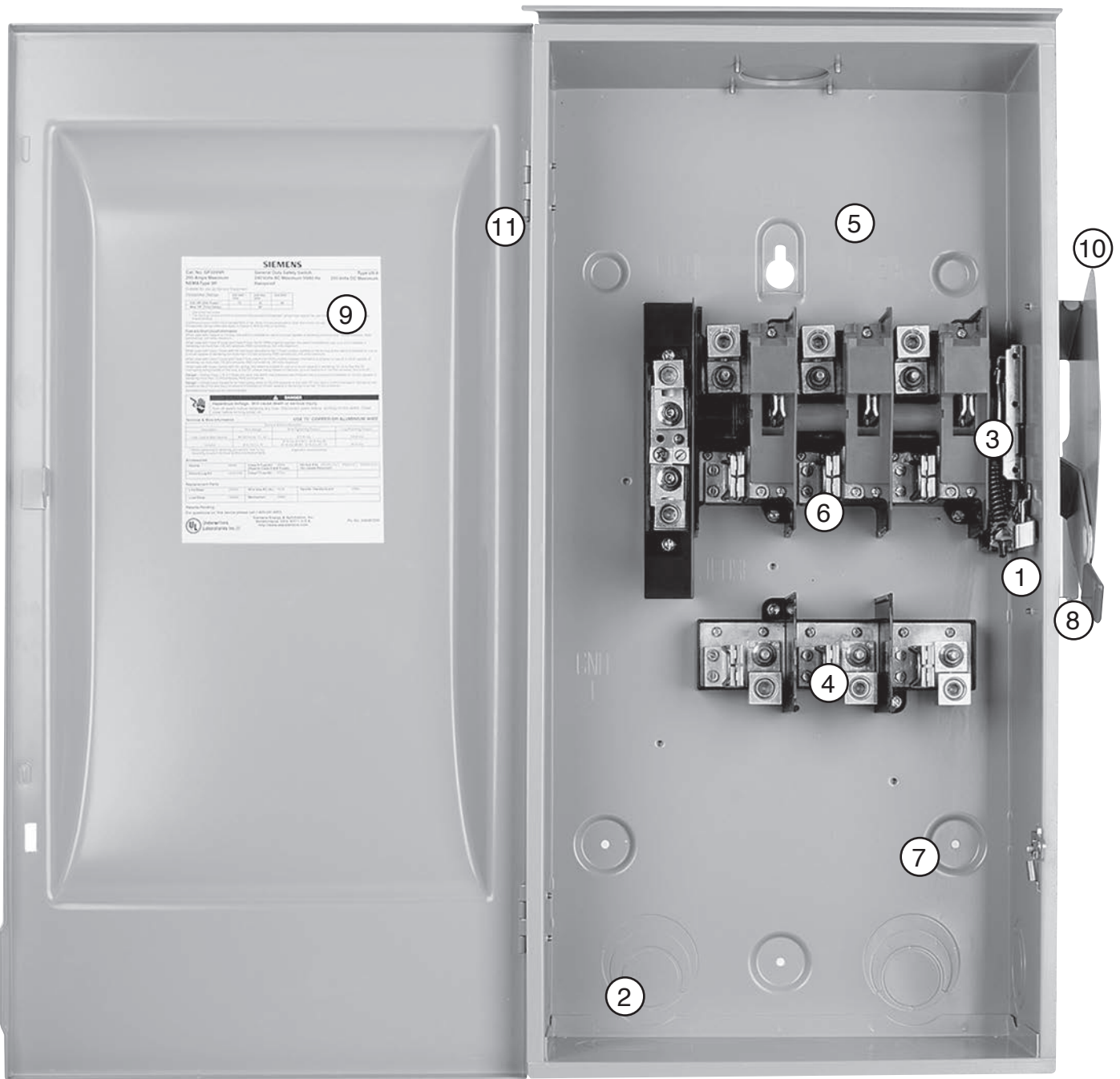

1. Cover interlock
 2. Tangential knockouts 100-600A for easy conduit lineup
 3. Quick-make, quick-break operating mechanism that ensures positive operation
 4. Provisions for T, R, J, H, and K class fuses (T & J 100-600A)
 5. Wiring gutters that meet or exceed NEC wire-bending space requirements
 6. Visible blade, double-break switch action
 7. Positive 2 or 3 point mounting
 8. Highly visible red handle grip
 9. Informative door labeling which includes replacement parts list
 10. Handle and cover padlocking provisions
 11. 100A and above have side-hinged door that opens 180 degrees for easier wiring
- Note.** 400A and 600A GD switches include internal shields which meet 2020 NEC 230.62 touch safe requirements for service entrance equipment.

Safety Switches

General Duty Safety Switches

Selection



System	Ampere Rating	Indoor — Type 1		Outdoor — Type 3R		Horsepower Rating ^①						
		Catalog Number	Ship Wt. (lbs.) Std. Pkg	Catalog Number	Ship Wt. (lbs.) Std. Pkg	240V AC			250 Volt DC			
						1-Phase, 2-Wire	2-Phase, 4-Wire	3-Phase, 3-Wire				
Std.	Max.	Std.	Max.	Std.	Max.	Std.						

240 Volt Fusible^②

2-Pole, 2-Fuse, and Solid Neutral^{②③}

240 Volt AC/250 Volt DC

	30	GF221NA ^④	30 ^⑤	GF221NRA ^{④⑥}	30 ^⑤	1½	3	—	—	3	7½	5
	30	GF221NLA ^⑦	20 ^⑤	GF221NRLA ^{④⑧}	20 ^⑤	1½	3	—	—	3	7½	5
	60	GF222NA	20 ^⑤	GF222NRA ^④	20 ^⑤	3	10	—	—	7½	15	10
	100	GF223N	23	GF223NR	23	7½	15	—	—	15	30	20
	200	GF224N	47	GF224NR	48	15	—	—	—	25	60	40
	400	GF225NA	91	GF225NRA	91	—	—	—	—	50	125	50
	600	GF226NA	92	GF226NRA	92	—	—	—	—	75	200	50

3-Pole, 3-Fuse, and Solid Neutral^③

240 Volt AC/250 Volt DC

	30	GF321NA ^④	30 ^⑤	GF321NRA ^{④⑥}	30 ^⑤	1½	3	—	—	3	7½	5
	30	GF321NLA ^⑦	20 ^⑤	GF321NRLA ^{④⑧}	20 ^⑤	1½	3	—	—	3	7½	5
	60	GF322NA	20 ^⑤	GF322NRA ^④	20 ^⑤	3	10	—	—	7½	15	10
	100	GF323N	25	GF323NR	25	7½	15	—	—	15	30	20
	200	GF324N	49	GF324NR	50	15	—	—	—	25	60	40
	400	GF325NA	94.6	GF325NRA	94.6	15	—	—	—	50	125	50
	600	GF326NA	95.6	GF326NRA	95.6	15	—	—	—	75	200	—

240 Volt Non-Fusible^{③⑩}

2-Pole or 3-Pole

240 Volt AC/250 Volt DC

	30	GNF221A ^{④⑪}	20 ^⑤	GNF221RA ^{④⑫}	20 ^⑤	—	3	—	—	—	—	5
	30	GNF221LA ^⑦	30 ^⑤	GNF221RLA ^{④⑬}	30 ^⑤	—	3	—	—	7½	—	5
	30	GNF221LLA ^⑩	20 ^⑤	GNF221RLLA ^{④⑭}	20 ^⑤	—	3	—	—	7½	—	5
	30	GNF321A ^{④⑮}	20 ^⑤	GNF321RA ^{④⑯}	20 ^⑤	—	3	—	—	7½	—	5
	30	GNF321LA ^⑦	30 ^⑤	GNF321RLA ^{④⑰}	30 ^⑤	—	3	—	—	7½	—	5
	30	GNF321LLA ^⑩	20 ^⑤	GNF321RLLA ^{④⑱}	20 ^⑤	—	3	—	—	7½	—	5
	60	GNF222A	30 ^⑤	GNF222RA ^④	30 ^⑤	—	10	—	—	15	—	10
	60	GNF222LA ^⑦	20 ^⑤	GNF222RLA ^{④⑲}	20 ^⑤	—	10	—	—	15	—	10
	60	GNF322A	30 ^⑤	GNF322RA ^④	30 ^⑤	—	10	—	—	15	—	10
	60	GNF322LA ^⑦	20 ^⑤	GNF322RLA ^{④⑲}	20 ^⑤	—	10	—	—	15	—	10
	100	GNF323	23	GNF323R	24	—	15	—	—	30	—	20
	200	GNF324	46	GNF324R	47	—	15	—	—	60	—	40
	400	GNF325A	114	Use 600V Switch — HNF365RA	—	—	15	—	—	125	—	50
	600	GNF326A	116	Use 600V Switch — HNF366RA	—	—	15	—	—	200	—	—

① Dual horsepower ratings: Std.- applies when non-time delay fuses are installed. Max.- applies when time-delay fuses are installed.
 ② These switches are UL-listed for application on grounded B-phase systems.
 ③ Service entrance labeled unless otherwise noted.
 ④ Has provision for ECHA type hub.
 ⑤ 5 switches per standard package.

⑥ 10 switches per standard package.
 ⑦ Height reduced switch (45.25 rather than 56 inches in height) for use with 500MCM or smaller conductors.
 ⑧ Not suitable for service entrance.
 ⑨ PLUS series: larger enclosure, metal handle, quick make-break action.
 ⑩ Internal shields for 30A to 200A switches to meet 2020 NEC 230.62 touch safe requirements for service

entrance equipment can be purchased separately. See accessory section for catalog numbers.
 ⑪ MAX series: largest enclosure option for 30A non-fusible, included same upgraded features as PLUS series and additional KOs.
 ⑫ PLUS series: largest enclosure option for 60A non-fusible, 30A fusible.
 ⑬ Compact series

Safety Switches

Heavy Duty Safety Switches

Features

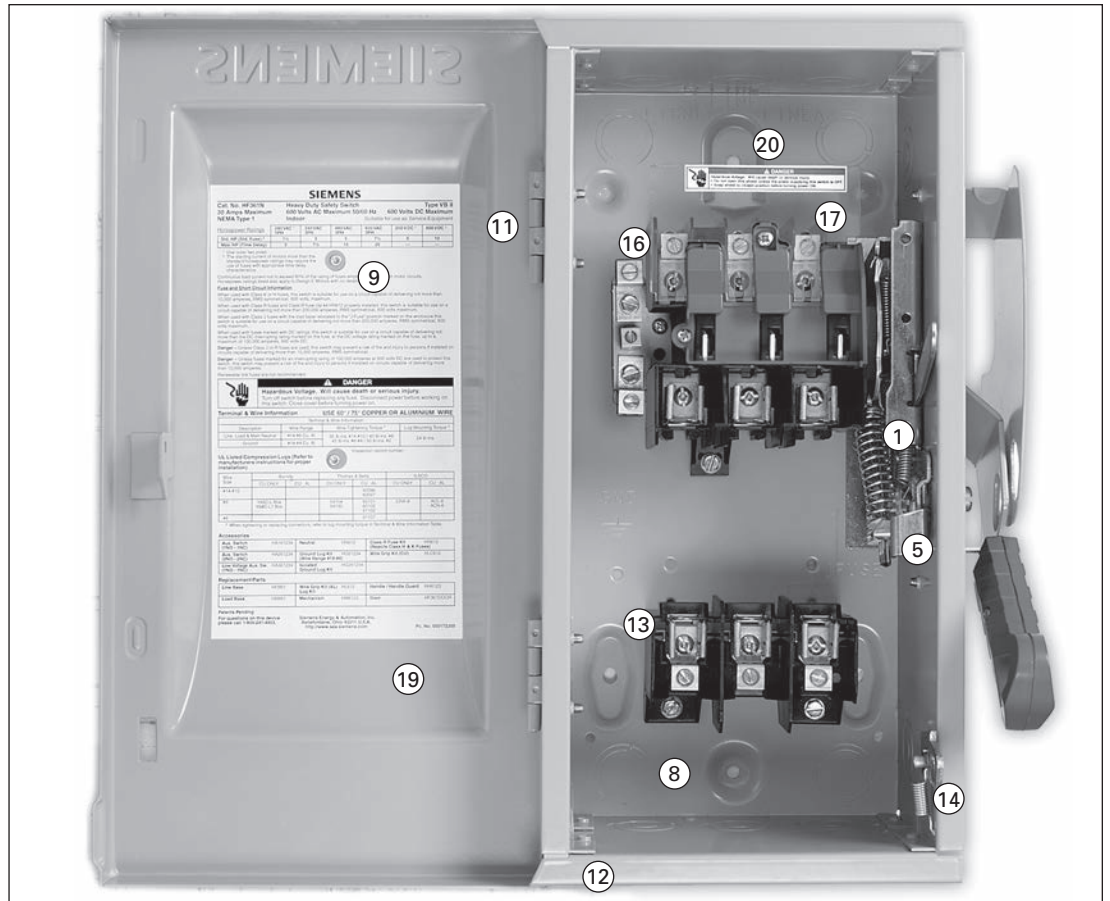
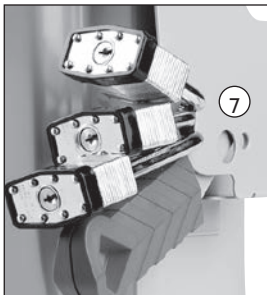
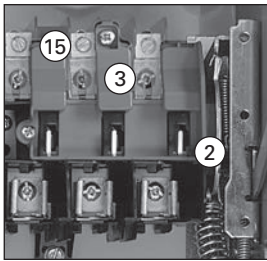

1. Quick-make, quick-break operating mechanism that ensures positive operation.
2. Visible blade, double-break switching action.
3. Arc chutes dissipate heat and prolong switch life.
4. Highly visible red handle grip. Designed for hook stick operation.
5. Defeatable dual cover interlock.
6. Center punch provided for field drilling to allow ON padlocking.
7. Handle can be padlocked in the OFF position with up to (3) padlocks with 5/16" hasps.
8. Generous top, bottom and side gutters that meet or exceed NEC wire-bending space requirements.
9. Informative door labeling which includes replacement parts list.
10. Tangential knockouts through 600A for easy conduit lineup.
11. Side-hinged door that opens past 180 degrees for easier wiring.
12. Unique enclosure design increases rigidity and prevents cuts and scrapes to conductors and installer's hands.
13. Spring reinforced fuse clips that assure reliable contact for cool operation.
14. Door latch securely holds door closed and allows cover padlocking.
15. Front removable mechanical lugs that are suitable for CU/Al 60 or 75° C conductors.
16. Lugs are field convertible to copper body and to a wide variety of compression connectors.
17. Hinged clear line terminal shield with probe holes for inspecting or testing line side terminals.
18. Embossed aluminum nameplate on Heavy Duty Switches provides highly visible ON/OFF indication.
19. Drawn cover for increased rigidity and resistance to abuse.
20. Top key hole and bottom mounting holes provide easy 2 or 3 point mounting.

Safety Switches

Heavy Duty Safety Switches

Selection



System	Ampere Rating	Indoor — Type 1		Outdoor — Type 3R		Horsepower Rating ^①					
		Catalog Number	Ship Wt. (lbs.) Std. Pkg	Catalog Number	Ship Wt. (lbs.) Std. Pkg	240V AC				250 Volt DC	
						1-Phase, 2-Wire	2-Phase, 4-Wire	3-Phase, 3-Wire			
Std.	Max.	Std.	Max.	Std.	Max.	Std.	Max.	Std.			

240 Volt Fusible^⑤

2-Pole, 2-Fuse, and Solid Neutral^③ (Also used for 2-Pole, 2-Wire Applications) 240 Volt AC/250 Volt DC

Ampere Rating	Indoor Type 1 Catalog Number	Indoor Type 1 Ship Wt. (lbs.) Std. Pkg	Outdoor Type 3R Catalog Number	Outdoor Type 3R Ship Wt. (lbs.) Std. Pkg	1-Phase, 2-Wire Std.	1-Phase, 2-Wire Max.	2-Phase, 4-Wire Std.	2-Phase, 4-Wire Max.	3-Phase, 3-Wire Std.	3-Phase, 3-Wire Max.	250 Volt DC Std.
30	HF221N	12	HF221NR	13	1½	3	—	—	3	7½	5
60	HF222N	18	HF222NR	19	3	10	—	—	7½	15	10
100	HF223N	23	HF223NR	24	7½	15	—	—	15	30	20
200	HF224N	47	HF224NR	48	15	—	—	—	25	60	40
400	HF225NA	91.1	HF225NRA	91.1	15	—	—	—	50	125	50
600	HF226NA	95.6	HF226NRA	95.6	15	—	—	—	75	200	50
800	HF227N	365	HF227NR	365	—	—	—	—	100	250	50
1200	HF228N■	385	HF228NR■	385	—	—	—	—	100	250	50

3-Pole, 3-Fuse, and Solid Neutral (Also used for 3-Pole, 3-Wire Applications) 240 Volt AC/250 Volt DC

Ampere Rating	Indoor Type 1 Catalog Number	Indoor Type 1 Ship Wt. (lbs.) Std. Pkg	Outdoor Type 3R Catalog Number	Outdoor Type 3R Ship Wt. (lbs.) Std. Pkg	1-Phase, 2-Wire Std.	1-Phase, 2-Wire Max.	2-Phase, 4-Wire Std.	2-Phase, 4-Wire Max.	3-Phase, 3-Wire Std.	3-Phase, 3-Wire Max.	250 Volt DC Std.
30	HF321N	14	HF321NR	15	1½	3	—	—	3	7½	5
60	HF322N	19	HF322NR	20	3	10	—	—	7½	15	10
100	HF323N	25	HF323NR	26	7½	15	—	—	15	30	20
200	HF324N	49	HF324NR	50	15	—	—	—	25	60	40
400	HF325NA	94.6	HF325NRA	94.6	15	—	—	—	50	125	50
600	HF326NA	99.6	HF326NRA	99.6	15	—	—	—	75	200	50
800	HF327N	375	HF327NR	375	—	—	—	—	100	250	50
1200	HF328N	395	HF328NR	388	—	—	—	—	100	250	50

240 Volt Fusible^⑤

2-Pole, 2-Fuse^④ 240 Volt AC/250 Volt DC

Ampere Rating	Type 4/4X Stainless ^②		Type 12 Industrial ^②		1-Phase, 2-Wire Std.	1-Phase, 2-Wire Max.	2-Phase, 4-Wire Std.	2-Phase, 4-Wire Max.	3-Phase, 3-Wire Std.	3-Phase, 3-Wire Max.	250 Volt DC Std.
	Catalog Number	Ship Wt. (lbs.) Std. Pkg	Catalog Number	Ship Wt. (lbs.) Std. Pkg							
30	HF221S	13	HF221J	13	1½	3	—	—	3	7½	5
60	HF222S	19	HF222J	19	3	10	—	—	7½	15	10
100	HF223S	24	HF223J	24	7½	15	—	—	15	30	20
200	HF224S	48	HF224J	48	15	—	—	—	25	60	40

3-Pole, 3-Fuse^④ (Also used for 2-Pole, 2-Wire Applications in 400–800A Ratings) 240 Volt AC/250 Volt DC

Ampere Rating	Indoor Type 1 Catalog Number	Indoor Type 1 Ship Wt. (lbs.) Std. Pkg	Outdoor Type 3R Catalog Number	Outdoor Type 3R Ship Wt. (lbs.) Std. Pkg	1-Phase, 2-Wire Std.	1-Phase, 2-Wire Max.	2-Phase, 4-Wire Std.	2-Phase, 4-Wire Max.	3-Phase, 3-Wire Std.	3-Phase, 3-Wire Max.	250 Volt DC Std.
30	HF321S	14	HF321J	14	1½	3	—	—	3	7½	—
60	HF322S	20	HF322J	20	3	10	—	—	7½	15	10
100	HF323S	25	HF323J	25	7½	15	—	—	15	30	20
200	HF324S	49	HF324J	49	15	—	—	—	25	60	40
400	HF325SA	93	HF325JA	93	15	—	—	—	50	125	50
600	HF326SA	98	HF326JA	98	15	—	—	—	75	200	50
800	HF327S■	370	HF327J■	365	—	—	—	—	100	250	50

■ Built to order. Allow 3-5 weeks for delivery.

① Height reduced switch (45.25 rather than 56 inches in height) for use with 500MCM or smaller conductors.

② Dual horsepower ratings: Std.- applies when non-time delay fuses are installed. Max.- applies when time-delay fuses are installed.

③ These switches are UL-listed for application on grounded B-phase systems and are suitable for 3-phase motor applications.

④ When a neutral is required use a field installed neutral kit.

⑤ Suitable for use as service entrance equipment.

⑥ Also rated Type 3S/3R.

⑦ 304 grade stainless steel. For switches with enclosures constructed from 316 grade stainless steel, substitute "SS" in catalog number for "S." 316 available up to 600A.

Heavy Duty Safety Switches

Selection



System	Ampere Rating	Indoor — Type 1		Outdoor — Type 3R		Horsepower Rating [Ⓞ]									
		Catalog Number	Ship Wt. (lbs.) Std. Pkg	Catalog Number	Ship Wt. (lbs.) Std. Pkg	480V AC				600V AC				250 Volt DC	600 Volt DC
						1-Phase, 2-Wire		3-Phase, 3-Wire		1-Phase, 2-Wire		3-Phase, 3-Wire			
Std.	Max.	Std.	Max.	Std.	Max.	Std.	Max.	Std.	Max.	Std.	Max.	Std.	Max.		

600 Volt Fusible[Ⓞ]

2-Pole, 2-Fuse [Ⓞ]						480 Volt AC/600 Volt AC/600 Volt DC									
	30	HF261	15	HF261R	15	3	7½	—	—	3	10	—	—	5	15
	60	HF262	20	HF262R	20	5	20	—	—	10	25	—	—	10	30
	100	HF263	26	HF263R	27	10	30	—	—	15	40	—	—	20	50

3-Pole, 3-Fuse						480 Volt AC/600 Volt AC/250 Volt DC [Ⓛ]									
	30	HF361	14	HF361R	15	3	7½	5	15	3	10	7½	20	5	—
	30	HF361L [Ⓞ]	19	HF361RL [Ⓞ]	20	3	7½	5	15	3	10	7½	20	5	—
	60	HF362	19	HF362R	20	5	20	15	30	10	25	15	50	10	30 [Ⓞ]
	60	—	—	HF362RL [Ⓞ]	25	5	20	15	30	10	25	15	50	10	30 [Ⓞ]
	100	HF363	24	HF363R	25	5	20	25	60	15	40	30	75	20	50 [Ⓞ]
	200	HF364	48	HF364R	49	25	50	50	125	30	50	60	150	40	50
	400	HF365A [Ⓛ]	93	HF365RA [Ⓛ]	157	—	—	100	250	—	—	125	350	50	—
	600	HF366A [Ⓛ]	98	HF366RA [Ⓛ]	161	—	—	150	400	—	—	200	500	50	—
800	HF367	365	HF367R	365	—	—	200	500	—	—	250	500	50	—	
1200	HF368	383	HF368R	385	—	—	200	500	—	—	250	500	50	—	

3-Pole, 3-Fuse and Solid Neutral						480 Volt AC/600 Volt AC/250 Volt DC [Ⓛ]									
	30	HF361N	14	HF361NR	15	3	7½	5	15	3	10	7½	20	5	—
	60	HF362N	19	HF362NR	20	5	20	15	30	10	25	15	50	10	30 [Ⓞ]
	100	HF363N	25	HF363NR	26	10	30	25	60	15	40	30	75	20	50 [Ⓞ]
	200	HF364N	49	HF364NR	50	25	50	50	125	30	50	60	150	40	50
	400	HF365NA	94.6	HF365NRA	94.6	—	—	100	250	—	—	125	350	50	—
	600	HF366NA	99.6	HF366NRA	99.6	—	—	150	400	—	—	200	500	50	—
	800	HF367N	375	HF367NR	375	—	—	250	500	—	—	250	500	50	—
	1200	HF368N	395	HF368NR	388	—	—	250	500	—	—	250	500	50	—

600 Volt Fusible[Ⓞ]

2-Pole, 2-Fuse [Ⓞ]						480 Volt AC/600 Volt AC/600 Volt DC									
	Ampere Rating	Type 4/4X Stainless [Ⓞ]		Type 12 Industrial [Ⓞ]		Std.	Max.	Std.	Max.	Std.	Max.	Std.	Max.	Std.	Max.
		Cat. No.	Ship Wt.	Cat. No.	Ship Wt.										
30	HF261S	15	HF261J■	15	3	7½	—	—	3	10	—	—	5	15	
60	HF262S	20	HF262J■	20	5	20	—	—	10	25	—	—	10	30	
100	HF263S■	27	HF263J■	27	10	30	—	—	15	40	—	—	20	50	

3-Pole, 3-Fuse						480 Volt AC/600 Volt AC/250 Volt DC [Ⓛ]									
	30	HF361S	13	HF361J	14	—	—	5	15	—	—	7½	20	5	—
	60	HF362S	20	HF362J	20	—	—	15	30	—	—	15	50	10	30 [Ⓞ]
	100	HF363S	25	HF363J	25	—	—	25	60	—	—	30	75	20	50 [Ⓞ]
	200	HF364S	49	HF364J	49	—	—	50	125	—	—	60	150	40	50
	400	HF365SA [Ⓛ]	93	HF365JA [Ⓛ]	93	—	—	100	250	—	—	125	350	50	—
	600	HF366SA [Ⓛ]	98	HF366JA [Ⓛ]	98	—	—	150	400	—	—	200	500	50	—
	800	HF367S	370	HF367J■	365	—	—	200	500	—	—	250	500	50	—
	1200	HF368S■	388	HF368J■	388	—	—	250	500	—	—	250	500	50	—

■ Built to order. Allow 3-5 weeks for delivery.
 Ⓛ 60-600A 3-Pole switches are also rated 600V DC.
 Ⓞ Height reduced switch (45.25 rather than 56 inches in height) for use with 500MCM or smaller conductors.
 Ⓞ Use 3-Pole switch for 200A applications.
 Ⓞ Dual horsepower ratings: Std.- applies when non-time delay fuses are installed. Max.- applies when time-delay fuses are installed.
 Ⓞ Suitable for use as service entrance equipment except on 1200 Amp solidly grounded wye systems per NEC 230.95.
 Ⓞ Also rated Type 3S/3R.
 Ⓞ Indicates oversized enclosure (30A switch with 60A lugs in a 60A enclosure or 60A switch with 100A lugs in a 100A enclosure).
 Ⓞ 600V DC & 600V DC horsepower rating shown requires (2) poles to be connected in series.
 Ⓞ 304 grade stainless steel. For switches with enclosures constructed from 316 grade stainless steel, substitute "SS" in catalog number for "S." 316 available up to 600A.

Safety Switches

Heavy Duty Safety Switches

Selection



System	Ampere Rating	Indoor — Type 1		Outdoor — Type 3R		Horsepower Rating							
		Catalog Number	Ship Wt. (lbs.)	Catalog Number	Ship Wt. (lbs.)	240 Volt		480 Volt		600 Volt		250V DC	600V DC
						1-Phase	3-Phase	1-Phase	3-Phase	1-Phase	3-Phase		

600 Volt Non-Fusible^④

2-Pole^③

						480 Volt AC / 600 Volt AC / 600 Volt DC							
	30	HNF261	12	HNF261R	13	—	—	7½	—	10	—	5	15
	60	HNF262	19	HNF262R	20	—	—	20	—	25	—	10	30
	100	HNF263	24	HNF263R	25	—	—	30	—	40	—	20	50

3-Pole

						480 Volt AC / 600 Volt AC / 250 Volt DC							
	30	HNF361	12	HNF361R	13	5	10	7½	20	10	30	5	—
	30	—	—	HNF361RL ^⑥	19	5	10	7½	20	10	30	5	—
	60	HNF362H ^②	11	HNF362RH ^②	11	10	20	20	50	20	40	10	—
	60	HNF362 ^①	18	HNF362R ^①	19	10	20	20	50	25	60	10	30 ^②
	60	—	—	HNF362RL ^⑥	24	10	20	20	50	25	60	10	30 ^②
	100	HNF363 ^①	23	HNF363R ^①	24	15	40	30	75	40	100	20	50 ^②
	200	HNF364 ^①	46	HNF364R ^①	47	15	60	50	125	50	150	40	50
	400	HNF365A ^①	75	HNF365RA ^①	75	15	125	50	250	50	350	50	—
	600	HNF366A ^①	77	HNF366RA ^①	77	15	200	50	400	50	500	50	—
	800	HNF367	295	HNF367R	295	15	250	50	500	50	500	50	—
1200	HNF368	305	HNF368R	307	15	250	50	500	50	500	50	—	

600 Volt Non-Fusible^④

2-Pole^③

						480 Volt AC / 600 Volt AC / 600 Volt DC							
		Type 4 / 4X Stainless ^⑥		Type 12 Industrial ^⑤									
		30	HNF261S	13	HNF261J	13	—	—	7½	—	10	—	5
60	HNF262S	20	HNF262J	20	—	—	20	—	25	—	10	30	
100	HNF263S■	25	HNF263J■	25	—	—	30	—	40	—	20	50	

3-Pole

						480 Volt AC / 600 Volt AC / 250 Volt DC							
	30	HNF361S	13	HNF361J	13	5	10	7½	20	10	30	5	—
	60	HNF362SH ^②	15	HNF362JH ^②	14	10	20	20	50	20	40	10	—
	60	HNF362S ^①	19	HNF362J ^①	19	10	20	20	50	25	60	10	30 ^②
	100	HNF363S ^①	24	HNF363J ^①	24	15	40	30	75	40	100	20	50 ^②
	200	HNF364S ^①	47	HNF364J ^①	47	15	60	50	125	50	150	40	50
	400	HNF365SA ^①	75	HNF365JA ^①	75	15	125	50	250	50	350	50	—
	600	HNF366SA ^①	77	HNF366JA ^①	77	15	200	50	400	50	500	50	—
	800	HNF367S	295	HNF367J■	295	15	250	50	500	50	500	50	—
	1200	HNF368S■	310	HNF368J■	310	15	250	50	500	50	500	50	—

■ Built to order. Allow 3-5 weeks for delivery.

① 60-600A 3-Pole switches are also rated 600V DC.

② Compact switch (11.1"H, 6.6"W box less cover and handle).

③ Short circuit withstand rating—100,000 RMS sym. amps.

④ Use 3-Pole switch for 200A application.

⑤ Suitable for use as service entrance equipment except for

1200 when used on a 480 or 600V grounded wye system.

⑥ Also rated type 3S / 3R.

⑦ Indicates oversized enclosure (30A switch in a 60A enclosure or a 60A switch in a 100A enclosure).

⑧ 600V DC and 600V DC horsepower rating shown

requires (2) poles to be connected in series.

⑨ 304 grade stainless steel. For switches with enclosures constructed from 316 grade stainless steel, substitute "SS" in catalog number for "S."

Heavy Duty Safety Switches

Type 3R, 4/4X, & 12 with Viewing Window

Description

30–600A, 3-pole 600V max. in fusible and non-fusible versions in Type 4/4X stainless steel, and Type 12, and select 3R enclosures.







All allow viewing of visible blade position with the door closed. 30–200A also allow viewing of indicating type fuses.

Features

- Rugged installer-friendly enclosure design features a gasket flange with continuously welded seams
- Tool-free cover latches

- Two, three and four point mounting
- Metal handle with large insulating grip features a positive stop in both ON and OFF position
- Ground lugs provided as standard in Type 12 and 4X switches
- Type 12 enclosures are fabricated from galvanized steel and are also rated for 3R/3S outdoor applications
- Type 4X stainless steel switches (30–200A) are provided with stainless steel interior parts
- The widest range of accessories available including 200% neutrals, gold plated PLC auxiliary contacts and isolated ground kits



System	Ampere Rating	Catalog Number	Ship Wt. (lbs.)	Maximum Horsepower Rating ^②					
				240V AC		480V AC	600V AC	250V DC	600V DC
				1-Phase, 2-Wire	3-Phase	3-Phase	3-Phase		
3-Pole, 3-Wire Fusible, Type 3R^④				600 Volt AC / 250 Volt DC^①					
	30	HF361RW	17	3	7½	15	20	5	—
	60	HF362RW	22	10	15	30	50	10	30 ^⑤
	800	HF367NRW	375	—	—	500	500	50	—
	1200	HF368NRW	388	—	—	500	500	50	—
3-Pole, 3-Wire Non-Fusible, Type 3R^④				600 Volt AC / 250 Volt DC^①					
	30	HNF361RW	14	3	10	20	30	5	—
	60	HNF362RW	21	10	20	50	60	10	30 ^⑤
	800	HNF367RW	295	15	250	500	500	50	—
	1200	HNF368RW	307	15	250	500	500	50	—
3-Pole, 3-Wire Fusible, Type 12^{③④}				600 Volt AC / 250 Volt DC^①					
	30	HF361JW	17	3	7½	15	20	5	—
	60	HF362JW	22	10	15	30	50	10	30 ^⑤
	100	HF363JW	26	15	30	60	75	20	50 ^⑤
	200	HF364JW	53	—	60	125	150	40	50
	400	HF365JWA	93	—	125	250	350	50	—
	600	HF366JWA	98	—	200	400	500	50	—
	800	HF367JW	365	—	—	500	500	50	—
	1200	HF368JW	388	—	—	500	500	50	—
3-Pole, 3-Wire Non-Fusible, Type 12^{③④}				600 Volt AC / 250 Volt DC					
	30	HNF361JW	14	3	10	20	30	5	—
	60	HNF362JW	21	10	20	50	60	10	30 ^⑤
	100	HNF363JW	25	15	40	75	100	20	50 ^⑤
	200	HNF364JW	51	15	60	125	150	40	50
	400	HNF365JWA	75	15	125	250	350	50	—
	600	HNF366JWA	77	15	200	400	500	50	—
	800	HNF367JW	295	15	250	500	500	50	—
	1200	HNF368JW	310	15	250	500	500	50	—
3-Pole, 3-Wire Fusible, Type 4X Stainless Steel^{④⑥}				600 Volt AC / 250 Volt DC^①					
	30	HF361SW	17	3	7½	15	20	5	—
	60	HF362SW	23	10	15	30	50	10	30 ^⑤
	100	HF363SW	28	15	30	60	75	20	50 ^⑤
	200	HF364SW	55	—	60	125	150	40	50
	400	HF365SWA	75	15	125	250	350	50	—
	600	HF366SW	98	—	—	400	500	50	—
	800	HF367SW	365	—	—	500	500	50	—
	1200	HF368SW	388	—	—	500	500	50	—
3-Pole, 3-Wire Non-Fusible, Type 4X Stainless Steel^{④⑥}				600 Volt AC / 250 Volt DC^①					
	30	HNF361SW	15	3	10	20	30	5	—
	60	HNF362SW	23	10	20	50	60	10	30 ^⑤
	100	HNF363SW	27	15	40	75	100	20	50 ^⑤
	200	HNF364SW	54	15	60	125	150	40	50
	400	HNF365SWA	75	15	125	250	350	50	—
	800	HNF367SW	295	15	250	500	500	50	—
	1200	HNF368SW	310	15	250	500	500	50	—

① 200A switches are also rated 600V DC.

② Maximum HP ratings listed apply only when time delay fuses are used.

③ Also rated 3S/3R for outdoor use.

④ All switches are suitable for use as service entrance equipment.

⑤ 600V DC and 600V DC horsepower rating shown requires (2) poles to be connected in series.

⑥ 304 grade stainless steel. For switches with enclosures constructed from 316 grade stainless steel, substitute "SS" in catalog number for "S."

Elevator Control Switches

Application

Siemens Type (ECS) Elevator Control disconnect switches are designed for single cable or hydraulic elevator application to interrupt the incoming AC power upon receiving a signal from the Fire Alarm Control Panel (FACP).

Description

The Elevator Control switch units come completely assembled for quick installation, eliminating the labor and time needed to assemble individual components. Therefore, the numbering system assures that you get all of the correct components, assembled with the correct ratings, without having to individually order accessories.

It is easy to meet Code requirements for selective coordination in a fully fused system. Siemens Type (ECS) Elevator Control disconnect switches utilize Class J fuses that easily coordinate with any upstream fuse by simply using a 2:1 line-side to load-side fuse ratio.

Standards

- UL 98 Enclosed and Dead Front Switch – Guide 96NK3917, File E182262



Catalog Number System

The following catalog numbering system defines an Elevator Control Switch construction.

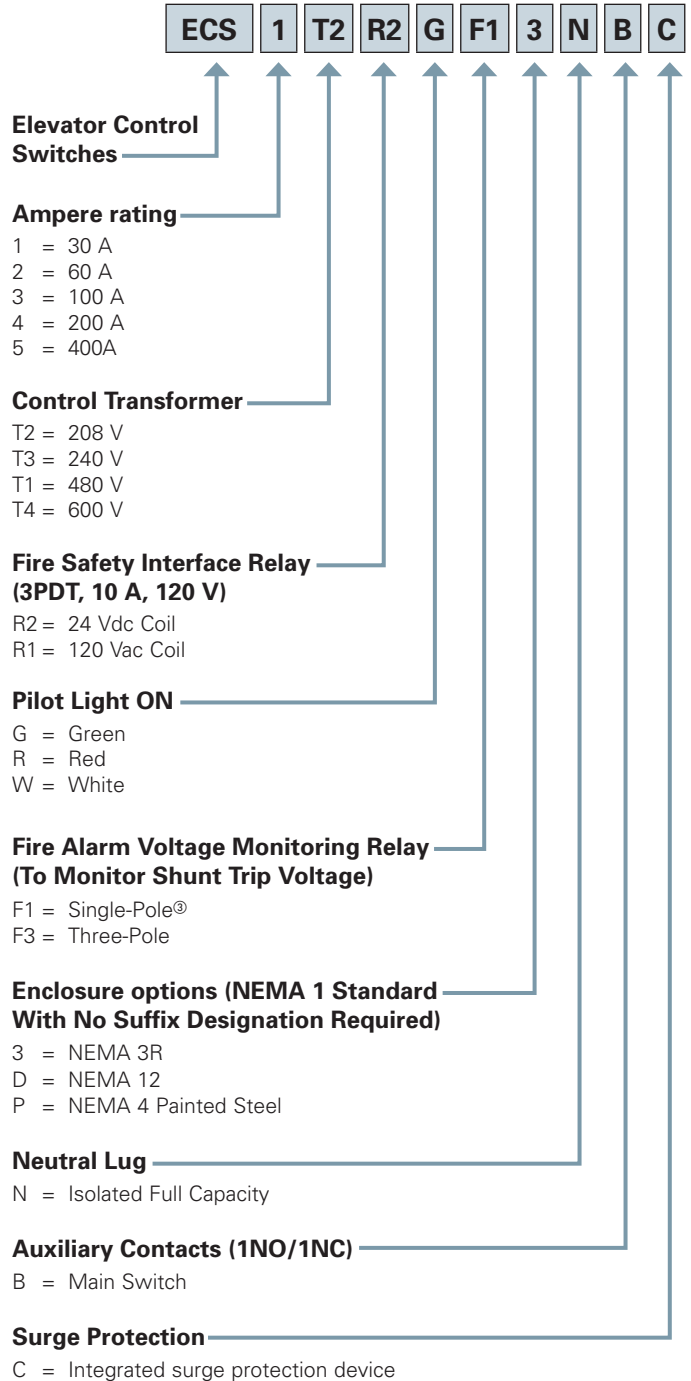

® 100 VA with Primary and Secondary fusing (120 V Secondary)
 ® For information on Siemens TPS3 03 protection device refer to product literature or Speedfax
 ® F1 must be selected if 24 Vdc Coil for safety interface relay (R2) is selected

Elevator Control Switches

Standard Features

- 30-400 A, 600 Vac, 3-phase fused power switch
- 200 kA RMS assembly short-circuit current rating
- Shunt trip 120 V
- Control power terminal block
- Ground lug compliant with the National Electric Code
- Class J fuse mounting only (Class J fuses not included)
- Key to test switch
- Pilot light – "ON"
- Mechanically interlocked auxiliary contact for hydraulic elevators with battery backup (5 A, 120 Vac rated)
- Handle designed for hook stick operation
- OSHPD Special Seismic Certification Preapproval (OSP)

Configurable Standard Features

- Control power transformer with fuses and blocks
- Fire safety interface relay
- Isolated neutral lug
- Fire Alarm Voltage Monitoring Relay (to monitor Shunt Trip Voltage)
- NEMA 3R, 4, and 12 enclosures available

Optional Features

- Oversized 200% rated neutral option available where required by excessive non-linear loads
- Additional auxiliary contact (1NO / 1NC)
- Integrated surge protection device (TPS3 03). Externally viewable through window in door

Other Options

Optional features include contact closure, i.e. battery lowering/door opening system. The B option offers support for the states of Arizona, Oregon, and Texas requirements to prevent "nuisance" fire alarms by over-riding the "Control Power not Available" signal when the Siemens Elevator control disconnect is manually (intentionally) turned off, and distinctive signaling for ON-OFF-TRIPPED conditions (Option B).

UL_A / NEC_B Listed Horsepower Ratings

Voltage / Poles	30A		60A		100A		200A		400A	
	Std ^②	Max ^①	Std ^②	Max ^①	Std ^②	Max ^①	Std ^②	Max ^①	Std ^②	Max ^①
208VAC / 3 Pole _B	2	5	5	10	10	15	20	40	40	75
240VAC / 3 Pole _A	2	7½	7½	15	15	30	25	60	50	75
480VAC / 3 Pole _A	5	15	15	30	25	60	50	125	100	150
6008VAC / 3 Pole _A	7½	20	15	50	30	75	60	150	125	200

Fuse and Short Circuit Information

This switch is suitable for use with Class J Fuses ONLY.

① Max HP with time delay Class J Fuses.
 ② Max HP with non-time delay Class J Fuses.

All Siemens Elevator Control elevator disconnect switches are UL-Listed and designed for safe access by qualified personnel. When maintenance or shutdown service is required, no energized parts are exposed inside the enclosure when the disconnect switch is manually turned to the OFF position. For proper maintenance safety precautions, always turn off incoming power to the Siemens Elevator Control elevator switch when possible. When servicing any live electrical equipment, always wear appropriate personal protective equipment.

Shunt-Trip Operation

The disconnect means is a shunt-trip operated switch. The control power source for the shunt-trip operator is a 120 Vac supply originating in the Siemens Elevator Control switch. Current to the shunt-trip device is switched by an isolation relay, which is in turn controlled by the FACP.

The control signal may be either 24 Vdc from the FACP (Option R2) or a "dry" contact closure in the FACP (Option R1). In the case of a "dry" contact closure, the sensing voltage is 120 Vac originating in the Siemens Elevator Control switch.

A key test switch (Option K) is included for testing the shunttrip circuit.

Supervisory Indication

Additionally, an optional separate relay can be specified to monitor the 120 Vac control power source in the Siemens Elevator Control switch. This relay (Option F1 or F3) is used to provide supervisory indication of "Control Power Available" as required by NFPA 72 Section 6.15.4.4.

Transformer Fuse Details

ECS Voltage/ Transformer Voltage	Primary Fuse (amps)	Secondary Fuse (amps)
208/120	FNQ-R-2	FNM-1 1/4
240/120	FNQ-R-2	FNM-1 1/4
480/120	FNQ-R-1	FNM-1 1/4
600/120	FNQ-R-1	FNM-1 1/4

Safety Switches

Type VBII 4 & 6-Pole Heavy Duty Safety Switches

Selection

Application

4 & 6-pole Switches are commonly used as a disconnecting means for two-speed, two-winding motors. Fused switches provide both over current and short circuit protection. Non-fusible switches normally provide a local disconnection means for two-speed motors which are remote from their motor controller. 4-pole switches are also used in 3-phase, 4-wire circuits when a switching neutral is required. All 4 & 6-pole switches are service entrance rated.

Description

4 & 6-pole switches are available in 30-200A ratings and in both fusible and non-fusible versions. 4-pole switches are supplied with either Type 1 or Type 12/3R enclosures. 6-pole switches are available with either Type 12/3R or Type 4X stainless steel enclosures.

Standards

- UL & CUL listed under file #E4776
- Meets UL98 for enclosed switches
- 4 & 6-Pole switches are suitable for use as service entrance
- Meets NEMA Standard KS-1 for enclosed switches
- Meets NEC wire bending space requirements

Features

- Visible blade, double break switching action
- Highly visible ON/OFF indication
- Defeatable dual cover interlock
- Padlock option in OFF position
- All copper current carrying parts^①
- Tangential knockouts (Type 1, 4-pole switches)



HNF662J

4-Pole Type VBII Switches^{①②}

System	Amp Rating	Indoor Type 1		Type 12/3R Industrial ^③		Horsepower Ratings ^③				480V, 3Ø		600V, 3Ø		250V DC
		Catalog Number	Ship Wt. (lbs.)	Catalog Number	Ship Wt. (lbs.)	240V, 2Ø, 4W		240V 3Ø		Std.	Max.	Std.	Max.	

Fusible 600 Volt AC, 250 Volt DC — 4-Pole, 4 Fuse^④

	30	HF461	36	HF461J	36	3	10	3	7½	5	15	7½	20	5
	60	HF462	40	HF462J	40	7½	20	7½	15	15	30	15	50	10
	100	HF463	43	HF463J	43	15	30	15	30	25	60	30	75	20
	200	HF464	88	HF464J	88	25	50	25	60	50	125	60	150	40

Non-fusible 600 Volt AC, 250 Volt DC — 4-Pole

	30	HNF461	32	HNF461J	32	—	10	—	10	—	20	—	30	5
	60	HNF462	34	HNF462J	34	—	20	—	20	—	50	—	60	10
	100	HNF463	36	HNF463J	36	—	30	—	40	—	75	—	100	20
	200	HNF464	78	HNF464J	78	—	50	—	60	—	125	—	150	4

6-Pole Type VBII Switches^{①②⑤}

System	Amp Rating	Type 12/3R Industrial		Type 4X Stainless Steel		Horsepower Ratings ^③				250V DC
		Catalog Number	Ship Wt. (lbs.)	Catalog Number	Ship Wt. (lbs.)	240V 3Ø		480V, 3Ø		

Fusible 600 Volt AC, 250 Volt DC — 6-Pole, 6 Fuse^④

	30	HF661J	37	HF661S	37	3	7½	5	15	7½	20	5
	60	HF662J	41	HF662S	41	7½	15	15	30	15	50	10
	100	HF663J	44	HF663S	44	15	30	25	60	30	75	20
	200	HF664J	90	HF664S	90	25	60	50	125	60	150	40

Non-fusible 600 Volt AC, 250 Volt DC — 6-Pole

	30	HNF661J	33	HNF661S	33	—	10	—	20	—	30	5
	60	HNF662J	35	HNF662S	35	—	20	—	50	—	60	10
	100	HNF663J	37	HNF663S	37	—	40	—	75	—	100	20
	200	HNF664J	80	HNF664S	80	—	60	—	125	—	150	40

■ Built to order. Allow 3-5 weeks for delivery.

① Lugs are aluminum alloy as standard. Optional copper body lugs are available.

② All 4 & 6-pole VBII switches are suitable for use as service equipment when a neutral is installed or equipment ground kit is properly connected.

③ Dual horsepower ratings: Std. – applies when non-time-delay fuses are installed. Max. – applies when time delay fuses are installed.

④ Fusible switches accept Class H Fuses as the standard. Class R & J fuses can also be installed and increase the rating from 10,000 to 200,000 AIC. For

Class J, the load base is moved upward. For Class R fuses, rejection kits are required.

⑤ Supplied with factory installed ground lugs.

Special Application Safety Switches

Interlocked Receptacle Switches

Application

Receptacle Safety Switches provide cord connection protection of heavy-duty portable equipment (welders, infrared ovens, batch feeders, portable conveyors, assembly line fixtures and tools, refrigerator trucks, etc.) under load or fault conditions.

Standards

All receptacle switches are UL listed under file #E4776. Those with a viewing window are also CSA certified under file #1079316.

Description^{①②}

Type 12 and 4/4X Receptacle Safety Switches are available with 3-phase, 4-wire grounded type Crouse-Hinds Arkite™ 2 or Pyle-National receptacle, pre-wired and mounted with interlock linkage to the switch mechanism. Insertion or removal of the plug is prevented by the interlock linkage while the switch is in the "ON" position. Receptacle prevents operation of switch if incorrect plug is inserted.



HF362JCH

Crouse-Hinds Interlocked Receptacle Switches

Ampere Rating ^④	Type 12 ^⑤	Type 4/4X ^⑤	Shipping Wt. (lbs.) Std. Pkg.	Accepts Crouse-Hinds Arkite™ Plug Catalog Number
	Catalog Number	Catalog Number		

240V Fusible, 3-Pole, 3-Wire

30	HF321JCH	—	23	APJ3485 & NPJ3485
60	HF322JCH	—	30	APJ6485 & NPJ6485
100	HF323JCH	HF323SCH▲	36	APJ10487 & NPJ10487

600V Fusible, 3-Pole, 3-Wire

30	HF361JCH	HF361SCH	24	APJ3485 & NPJ3485
60	HF362JCH	HF362SCH	30	APJ6485 & NPJ6485
100	HF363JCH	HF363SCH▲	36	APJ10487 & NPJ10487

600V Non-Fusible, 3-Pole, 3-Wire

30	HNF361JCH▲	HNF361SCH▲	22	APJ3485 & NPJ3485
60	HNF362JCH	HNF362SCH	29	APJ6485 & NPJ6485
100	HNF363JCH▲	HNF363SCH▲	35	APJ10487 & NPJ10487

600V Fusible, 3-Pole, 3-Wire with Viewing Window

30	HF361JCHW▲	HF361SCHW▲	24	APJ3485 & NPJ3485
60	HF362JCHW	HF362SCHW	30	APJ6485 & NPJ6485
100	HF363JCHW▲	HF363SCHW▲	36	APJ10487 & NPJ10487

600V Non-Fusible, 3-Pole, 3-Wire with Viewing Window

30	HNF361JCHW▲	HNF361SCHW▲	22	APJ3485 & NPJ3485
60	HNF362JCHW	HNF362SCHW▲	29	APJ6485 & NPJ6485
100	HNF363JCHW▲	HNF363SCHW▲	35	APJ10487 & NPJ10487

Pyle-National Interlocked Receptacle Switches 3-Poles Fusible and Non-Fusible

Ampere Rating		Voltage Rating	Type 12 Catalog Number ^⑤	Shipping Wt. (lbs.) Std. Pkg.	Accepts Pyle-National QuelArc™ ^{②③} Plugs
Switch	Receptacle				Plug Catalog Number
30	30	600 (F)	HF361JPN▲	23	JPD-83046
		600 (N-F)	HNF361JPN	21	
60	60	600 (F)	HF362JPN▲	28	JPD-116046
		600 (N-F)	HNF362JPN	27	

▲ Built to order. Allow 6–8 weeks for delivery.

⑤ Arkite™ is a registered trademark of the Crouse-Hinds Company. Plugs are not sold or supplied by Siemens.

② Indicates plug with maximum diameter cable bushing.

③ QuelArc™ is a registered trademark of the Pyle-National Company.

④ Ampere rating of both switch and receptacle.

⑤ Also rated Type 3R/3S.

⑥ Enclosure is constructed of Type 304 stainless steel.

Special Application Safety Switches

Type VBII Non-Metallic & 316 Grade Stainless Steel

Application

Siemens Non-metallic and 316 grade stainless steel switches provide a superior level of corrosion resistance to assure trouble free performance in the most severe conditions. 316 grade stainless steel provides increased corrosion resistance when compared to 304 grade, especially in atmospheres containing a high level of chlorine commonly encountered in marine and waste management applications. Our non-metallic enclosures are constructed from fiberglass reinforced polyester and are extremely resistant to a wide range

of corrosive atmospheres. They allow a wide range of operating temperatures and their insulating properties virtually eliminate problems caused by internal condensation.

Description

30-200A, 600V Max, fusible and non-fusible switches are available in both non-metallic and 316 grade stainless steel versions. All are supplied with factory installed ground bars as standard. Viewing windows are also available in the stainless offering.



Type 4/4X Non-Metallic

Ampere Rating	Catalog Number	Ship Weight Std. pkg. (lbs.)	Horsepower Rating—3-Phase						250 Volts DC	600 Volts DC
			240 Volt AC		480 Volt AC		600 Volt AC			
			Std.	Max.	Std.	Max.	Std.	Max.		
3-Pole, 4-Wire, 240 Volt Fusible, Type 4X^⑤										
30	HF321NX	21	3	7½	—	—	—	—	5	—
60	HF322NX▲	22	7½	15	—	—	—	—	10	—
3-Pole, 4-Wire, 600 Volt AC Fusible, Type 4X^{②③⑤}										
30	HF361NX	21	3	7½	5	15	7½	20	5	15 ^④
60	HF362NX	22	7½	15	15	30	15	50	10	30 ^④
100	HF363NX▲ ^①	39	15	30	25	60	30	75	20	50 ^④
200	HF364NX▲ ^①	83	25	60	50	125	60	150	40	50
3-Pole, 3-Wire, 600 AC Volt Non-Fusible,^① Type 4X^{②③}										
30	HNF361X	20	—	7½	—	20	—	30	5	15 ^④
60	HNF362X	20	—	15	—	50	—	60	10	30 ^④
100	HNF363X▲	38	—	30	—	75	—	100	20	50 ^④
200	HNF364X▲	81	—	60	—	125	—	150	40	50

▲ Built to order. Allow 6-8 weeks for delivery.

① Also used for 240 volt applications.

② Add "L" to end of catalog number for switches less line & load lugs with mounting hardware for crimp type or copper body lugs.

③ 200A switches are also rated 600V DC max.

④ 600V DC voltage and horsepower rating shown requires (2) poles to be connected in series.

⑤ Supplied with factory installed neutral.

Enclosed Solar Photovoltaic (PV) Switches

Application, Description, Selection

Application

Solar disconnect switches are designed to be used in the DC portion of photovoltaic power generation circuits. They incorporate powerful magnets within the switch line base which work in combination with a double break switching action to quickly dissipate the very hot arc that is generated when a 600V DC circuit is opened under load. These circuits are defined by article 690 of the NEC which requires the grounded conductor to be at ground potential at all times and therefore cannot be switched.

Description

30-200A switches are available in both Type 1 and 3R enclosures and in both fusible and non-fusible versions. They are provided with an additional door mounted warning label as required by the NEC and are supplied with a factory installed equipment ground bar. They are built to UL98 requirements but are UL listed in file number E335018 as UL1741 photovoltaic disconnect switches. They are 3 pole switches that are approved to switch 3 separate 600V DC circuits (one per pole). The design incorporates

many of the standard VBII switch features including a rolled out enclosure front flange, a large metal operating handle, oversized line and load lugs and large wire gutters. 1000VDC photovoltaic switches are UL98B listed for solar applications and comply with article 690 of the NEC. The new 400-600Amp switches are also UL98B listed at 600VDC and come in NEMA Type 3R.

Solar Photovoltaic Enclosed Disconnect Switches

Ampere Rating	Indoor – Type 1		Outdoor – Type 3R		Rated Isc Per NEC Article 690
	Catalog Number	Ship Wt* Std. Pkg.	Catalog Number	Ship Wt* Std. Pkg.	
Negative Ground 3 Pole 3 Wire Fusible 600Volt DC					
30	HF361PV	14	HF361RPV	15	19.2 A
60	HF362PV	20	HF362RPV	21	38.4 A
100	HF363PV▲	25	HF363RPV	26	64.0 A
200	HF364PV▲	49	HF364RPV	50	128.0 A
Negative Ground 3 Pole 3 Wire Non-Fusible 600Volt DC					
30	HNF361PV	12	HNF361RPV	13	24.0 A
60	HNF362PV	19	HNF362RPV	20	48.0 A
100	HNF363PV▲	24	HNF363RPV	25	80.0 A
200	HNF364PV▲	47	HNF364RPV	48	160.0 A
Positive and Negative Ground, 1 Pole, Fusible 1000 Volt DC					
200	HF1104NPV▲	52	HF1104NRPV▲	53	128.0A
Positive and Negative Ground, 1 Pole, Non-Fusible 1000 Volt DC					
200	HNF1104NPV▲	50	HNF1104NRPV▲	51	160.0A
Positive Ground 3 Pole 3 Wire Fusible 600Volt DC					
30	HF361PVPG	14	HF361RPVPG	15	19.2 A
60	HF362PVPG▲	20	HF362RPVPG	21	38.4 A
100	HF363PVPG▲	25	HF363RPVPG▲	26	64.0 A
200	HF364PVPG▲	49	HF364RPVPG▲	50	128.0 A
Positive Ground 3 Pole 3 Wire Non-Fusible 600Volt DC					
30	HNF361PVPG	12	HNF361RPVPG	13	24.0 A
60	HNF362PVPG▲	19	HNF362RPVPG	20	48.0 A
100	HNF363PVPG▲	24	HNF363RPVPG▲	25	80.0 A
200	HNF364PVPG▲	47	HNF364RPVPG▲	48	160.0 A
Positive and Negative Ground, 2 Wire, 600Volt DC, Type 3R					
Amperage Rating	No. Poles	Fuse Type	Catalog Number	Ship Wt* Std. Pkg	Rated Isc Per NEC Article 690
400A	1	Fusible	HF165NRPV▲	165	256A
400A	1	Non-fusible	HNF165NRPV▲	127	256A
600A	1	Fusible	HF166NRPV▲	167	384A
600A	1	Non-fusible	HNF166NRPV▲	129	384A



HF361PV



HNF361RPV



HF362RPV

▲ Built to order. Allow 6-8 weeks for delivery.

* In pounds (lbs)

Note: All disconnects are rated at 10,000 AIC per UL requirements when used with or protected by Class K, J or R fuses rated at 600VDC.

Safety Switches

General and Heavy Duty Safety Switches

Accessories



HR612

Class R Fuse Clip Kits

All General Duty and Heavy Duty Switches are field convertible to accept Class R Fuse Clip Kits. The kits prevent the installation of Class H and K fuses (one kit required per 3-pole switch).

Class R Fuse Clip Kits

Catalog Number	Description
HR21A	30A, 240V Kit (GD only)
HR21	30A, 240V Kit (HD only)
HR612	30A, 600V Kit
HR22A	60A 240V Kit (GD only)
HR62	60A, 600V Kit
HR63	100A Kit
HR64	200A Kit
HR656A	400A Kit
HR656A	600A Kit

Class J Fusing

All 30-600A, 600V and 100-600A, 240V fusible Heavy Duty Switches are field convertible to accept Class J fuses by moving the load base to a pre-drilled J fuse position. All 100-600A fusible General Duty switches can also be field converted to accept Class J fuses.

Note: Only 600A switches require an adapter kit to be field converted to Class J.

Class J Fuse Kits

Catalog Number	Description
HJ66A	600A, 240V/600V Kit

Internal Shield Kits (for fusible switches)

Kits provide a clear plastic inner door to prevent accidental contact with live parts. Test probe holes are provided and fuses can be replaced without removal of kit.

Note: All HD and 400A, 600A GD come with line-side shielding from the factory to meet NEC 230.62 requirements.

Internal Shield Kits[®]

Switch Ampere Rating	Kit Catalog Number	Coverage
30-60A GD Non-fusible	HSK212BA	Line side
30A GD Fusible	HSK21BA	Line side
60A GD Fusible	HSK22BA	Line side
100A GD	HSK23B	Line side
200A GD	HSK24B	Line side
30A HD Fusible ^②	HSK61SSW	Full
60A HD ^②	HSK62SSW	Full
100A HD ^②	HSK63SSW	Full
200A HD ^②	HSK64SSW	Full



HT63

Class T Fuse Adapter Kits

All 100-1200A Switches are field convertible to accept Class T fuses. 800A switch can accept class T without adapter kit

Class T Fuse Adapter Kits^①

Catalog Number	Description
HT23	100A, 240V Kit
HT63	100A, 600V Kit
HT24	200A, 240V Kit
HT64▲	200A, 600V Kit
HT25A	400A, 240V Kit
HT65A	400A, 600V Kit
HT26A	600A, 240V Kit
HT66A	600A, 600V Kit
No kit required	800A, 240V
No kit required	800A, 600V
TFAK82	1200A, 240V Kit



HN612

Neutral Kits

Standard Neutral Kits can be field installed in General and Heavy Duty Switches.

Neutral Kits

Switch Ampere Rating	Kit Catalog Number
30 GD	n/a
30 HD	HN612
60 GD	HN22A
60, 100 HD, 100 GD	HN623
200	HN64
400 & 600	HN656A
800 & 1200	HN678

▲ Built to order. Allow 6-8 weeks for delivery.

① One kit per pole required.

② Not designed for use in Non-metallic 4X safety switches. Not designed for use with Auxiliary Contacts.



HN264

200% Neutral Kits

UL listed 200% Neutrals are available on 100-600A Heavy Duty Switches. They are typically used with non-linear transformers or where increased neutral ampacity/lug capacity is required.

200% Neutral Kits

Switch Ampere Rating	Kit Catalog Number	Wire Range Line & Load Lugs (Cu/Al)
100	HN263	(2) #14-1/0 AWG
200	HN264	(2) #6 AWG-300 Kcmil
400	HN656A	(2) 1/0 AWG-600 Kcmil (2) #6 AWG-300 Kcmil
600	HN678A	(4) 1/0 AWG - 600 Kcmil (2) #6 AWG - 300 Kcmil

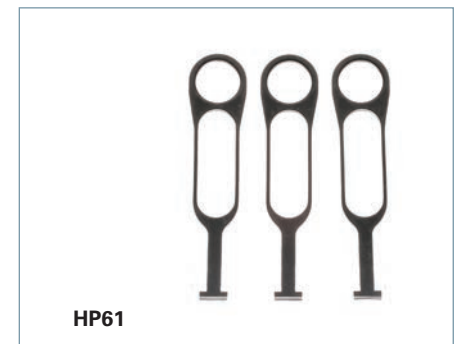

HP61

Fuse Puller Kits

Fuse Puller Kits are field installable in 30-100A Type VBII Heavy Duty Switches (one kit required per 3-pole switch).

Fuse Puller Kits

Switch Ampere Rating	Fuse Puller Kit Catalog Number
30	HP61
60	HP62▲
100	HP63▲

③ Internal shields meet 2020 NEC 230.62 requirements for service entrance. HD switches meet 2020 NEC 230.62—no additional shield necessary.

Safety Switches

General and Heavy Duty Safety Switches

Accessories



HA261234



HA265678

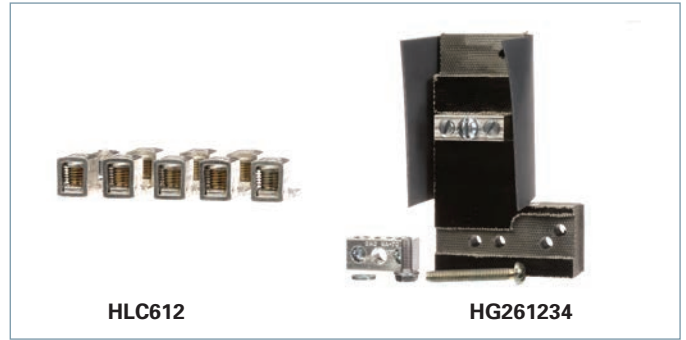

HLC612

HG261234

Auxiliary Contacts

Auxiliary Contacts are available only for Heavy Duty Switches. The auxiliary contacts are available in 1 normally open and 1 normally closed or 2 normally open and 2 normally closed configurations. Siemens offers a PLC Auxiliary Switch (30-600A) that has very low resistance for low voltage and current typical in PLC circuits. All auxiliary contacts make after and break before main switch contacts.

Auxiliary Contacts^①

Switch Ampere	Aux. Switch Catalog Number	Kit Ampere Rating			Horsepower Rating	
		125V AC Max.	250V AC Max.	28V DC Max.	125V AC Max.	250V AC Max.
30-600	HA161234	10	10	7	1/2	3/4
800-1200	HA165678	10	10	—	1/2	3/4

With 1 NO & 1 NC Isolated Contacts

30-600	HA161234	10	10	7	1/2	3/4
800-1200	HA165678	10	10	—	1/2	3/4

With 2 NO & 2 NC Isolated Contacts

30-600	HA261234	10	10	7	1/2	3/4
800-1200	HA265678	10	10	7	1/2	3/4

Low Current PLC Type with 1 NO & 1 NC Gold Plated Contacts

30-600	HA361234	10	10	7	1/2	3/4
800-1200	HA365678	10	10	—	1/2	3/4

Copper Lug Kits

Heavy duty switches are UL approved to accept field installed copper lug kits.

Copper Lug Kits

Switch Ampere Rating	Copper Lug Catalog Number	Description
30-60	HLC612	(9) Lugs/Kit #14-4 AWG Cu
100	HLC63▲	(9) Lugs/Kit #14-1/0 AWG Cu
200	HLC64▲	(9) Lugs/Kit #6 AWG-300 Kcmil Cu
400-600	HCU656A■	(1) Lugs/Kit #1/0 AWG-600 Kcmil Cu
800-1200	HLC65678	(1) Lugs/Kit #1/0 AWG-600 Kcmil Cu

▲ Built to order. Allow 6-8 weeks for delivery.

■ Purchase field replacement kit along with lugs.

① Series A 400A and 600A switches use HA161234, HA261234 or HA361234 auxiliary contacts. Earlier 400A and 600A switches use HA165678, HA265678 or HA365678 auxiliary contacts.

Quick Connects

They provide two point control power take-off capability and are normally used on two poles on the line side when it is required to have control power available when the switch is in the OFF position. They provide a mounting provision for standard ¼" quick connect terminal. Installed in the line or load side. 30A VBII switches have lugs UL listed to accept (2) wires per pole as standard so a 30A kit is not required.

Quick Connects

Catalog Number	Description
HQC62	60A 2 wire quick connect kit
HQC63	100A 2 wire quick connect kit
HQC64	200A 2 wire quick connect kit

Isolated Ground Kits

Isolated Ground Kits are available on 30-600A Heavy Duty Switches. They are normally used on circuits with a high content of computer or other electronic loading which require a ground which is isolated from the building ground and neutral circuits. The kit includes both isolated and grounded terminals as listed below.

Isolated Ground Kits

Switch Ampere Rating	Catalog Number	Number of Terminals		Wire Range Per Terminal (Cu/Al)
		Isolated	Grounded	
30-200	HG261234	2	2	#14-4 AWG
400-600	HG2656A	4	4	2/0-14 AWG 2/0-6 AWG

Equipment Ground Kits

Equipment Ground Lug Kits are available for all General and Heavy Duty Switches. They are field installable in Type 1 and Type 3R Switches and are factory installed as standard in Type 4 / 4X and Type 12 and also in all VBII 4&6-pole Switches.

Equipment Ground Kits

Switch Ampere Rating	Catalog Number	Number of Terminals	Wire Range Per Terminal (Cu/Al)
30-200 GD	HG61234	2	#14-4 AWG
30-200 HD	HG61234	2	#14-4 AWG
400 & 600	HG656A	4	2/0-6 AWG
800-1200	HG678	8	#6 AWG-250 Kcmil

Safety Switches

General and Heavy Duty Safety Switches

Hub and Lug Selection

Interchangeable Hubs

Conduit hubs are available for Type 3R, 12 and 4 / 4X applications. 30-200A Type 3R Switches are provided with a conduit hub provision and a removable hub plate on their top rainshed.

Conduit Size (inches)	Catalog Number	Used On
-----------------------	----------------	---------

Type 3R^①

Cover	Catalog Number	Used On
3/4	ECHA000	30-60A GD Only
1	ECHA075	
1 1/4	ECHA100	
1 1/4	ECHA125	
Cover	Catalog Number	Used On
3/4	ECHS000	100-200A GD 30-200A HD
1	ECHS075	
1 1/4	ECHS100	
1 1/4	ECHS125	
1 1/2	ECHS150	
2	ECHS200	
2 1/2	ECHS250	
2 1/2	ECHS250	
Cover	Catalog Number	Used On
3	ECHV300	400-1200A
3 1/2	ECHV350	
4	ECHV400	
4	ECHV400	

Type 4/4X^②

Cover	Catalog Number	Used On
3/4	SSH075	30-200A
1	SSH100	
1 1/4	SSH125	
1 1/2	SSH150	
2	SSH200	
2	SSH200	

Note: 30 thru 200A. Type 3R Switches have removable hub plates on rainshed. 400A and larger Type 3R Switches have no provisions for mounting hubs. Drill or punch hole in the field to accommodate hub size desired.

Field Replacement Kits and Neutral Barrier Kits

All Heavy Duty Switches are field convertible for (Crimp) type lugs. When compression lugs are required for 30-100A switches, a neutral barrier kit is required for 1-Phase, 3W or 3-Phase, 4W applications. When compression lugs are required on 400-1200A switches, lug mounting kits are required.

Field Replacement Kits and Neutral Barrier Kits

Switch Ampere Rating	Catalog Number	Kit Description
30	HCL612	Neutral Barrier Kit
60 & 100	HCL623	Neutral Barrier Kit
400	HCM65A	240V/600V Fusible Kit
400	HNCM65A	240/600V Non-Fusible Kit
600	HCM66A	240V/600V Fusible Kit
600	HNCM66A	240V/600V Non-Fusible Kit
800 ^⑤	HCL65678■	1 Pole, Compression Lug Mounting Kit

Lugs

30 & 60A HD Switches are suitable for use with 60° or 75°C wire. 100-1200A are suitable for use with 75°C rated wire.

Multiple Padlock Accessory

A tamper-proof device to provide for multiple padlocking to meet OSHA or plant requirements. Accepts up to 6 1/4" padlocks. Catalog number **SL0420**. Standard Carton-12.



Wire Ranges (Line, Load and Standard Neutral)

Switch Ampere Rating	Wire Range with Wire Bending Space Per NEC Requirements	Lug Wire Range
30GD	#14-8 AWG (Cu/Al)	#14-2 AWG (Cu/Al) ^⑥
60GD	#14-6 AWG (Cu)	#14-2 AWG (Cu) ^⑥
30HD	#14-6 AWG (Cu/Al)	#14-2 AWG (Cu/Al)
60HD ^⑧	#14-3 AWG (Cu/Al)	#14-2 AWG (Cu/Al)
100 ^⑩	#14-1/0 AWG (Cu/Al)	#14-1/0 AWG (Cu/Al)
200 ^⑨	#6 AWG-250 Kcmil (Cu/Al)	#6 AWG-300 Kcmil (Cu/Al)
400 ^②	(1) 1/0 AWG-600 Kcmil (Cu/Al) (2) 1/0 AWG-500 Kcmil (Cu/Al)	(2) 1/0 AWG-600 Kcmil (Cu/Al)
600 ^②	(1) 1/0 AWG-600 Kcmil (Cu/Al) (2) 1/0 AWG-500 Kcmil (Cu/Al)	(2) 1/0 AWG-600 Kcmil (Cu/Al)
800	(3) 1/0 AWG-750 Kcmil (Cu/Al) Line Load (4) 1/0 AWG-750 Kcmil (Cu/Al) neutral	(3) 1/0 AWG-750 Kcmil (Cu/Al) Line Load (4) 1/0 AWG-750 Kcmil (Cu/Al) neutral
1200	(4) 3/0 AWG-750 Kcmil (Cu/Al) Line Load (4) 1/0 AWG-750 Kcmil (Cu/Al) neutral	(4) 1/0 AWG-750 Kcmil (Cu/Al) Line Load (4) 1/0 AWG-750 Kcmil (Cu/Al) neutral

■ Built to order. Allow 3-4 weeks for delivery.

- ① Hubs suitable for 3R Switches.
- ② Also suitable for Type 12 applications.
- ③ Neutral Barrier kits are required on 30-100A switches only and only with 1-Phase / 3W or 3-Phase / 4W loads. Compression Lugs mounting kits are required on 400-1200A switches only.
- ④ Provides mounting for a single line or load lug.
- ⑤ Provides mounting for (2) compression lugs per phase on line or load.
- ⑥ Neutral lugs (only) are UL approved to accept #14-4 CU/Al cable.
- ⑦ Max. wire size for height reduced switches is 500 kcmil (Cu/Al).
- ⑧ Compact HD NF switches are also UL approved for #2 Cu/Al conductors.
- ⑨ All 200A Heavy Duty Switches have a wire range & wire bending space for (1) #6-300 Kcmil (Cu/Al).
- ⑩ Also for 30A oversized heavy duty switches.
- ⑪ Also for 60A oversized heavy duty switches.

Safety Switches

General and Heavy Duty Safety Switches

Dimensions

Safety Switch Dimensions (Inches)* & Shipping Weights

Catalog Number	Height			Width			Depth		Knockout Diagram [Ⓞ]	Approx. Shipping Weight (lbs.)
	Box A	With Door B	With Rain Shed C	Box D	With Handle E	Box F	With Handle G			
GF221NA, GF321NA	8.4	8.56	—	5.08	5.44	2.93	3.96	S4	30(10)	
GF221NRA, GF321NRA	8.4	8.56	8.56	5.08	5.44	2.93	3.96	S5	30(10)	
GF221NLA, GF321NLA	9.91	10.07	10.07	6.06	6.42	3.21	4.24	S26	20(5)	
GF221NRLA, GF321NRLA	9.91	10.07	—	6.06	6.42	3.21	4.24	S25	20(5)	
GF222NA, GF322NA	9.91	10.07	—	6.06	6.42	3.21	4.24	S21	20(5)	
GF222NRA, GF322NRA	9.91	10.07	10.07	6.06	6.42	3.21	4.24	S22	20(5)	
GF223N	21.95	23.15	—	9.64	11.7	5.05	8.63	S10	23	
GF223NR	21.95	—	23.46	9.64	11.67	5.05	8.7	S11	24	
GF224N	29.9	31.07	—	14.62	16.68	6.36	10.92	S12	47	
GF224NR	29.9	—	31.42	14.61	16.68	6.36	10.92	S13	48	
GF225NA	45.32	45.81	—	22.4	23.404	6.94	9.93	S18	91.1	
GF225NRA	45.32	45.81	—	22.4	23.404	6.94	9.93	S19	91.1	
GF226NA	45.32	45.81	—	22.4	23.404	6.94	9.93	S18	95.6	
GF226NRA	45.32	45.81	—	22.4	23.404	6.94	9.93	S19	95.6	
GF323N	21.95	23.15	—	9.64	11.7	5.05	8.63	S10	25	
GF323NR	21.95	—	23.46	9.64	11.67	5.05	8.7	S11	25	
GF324N	29.9	31.07	—	14.62	16.68	6.36	10.92	S12	49	
GF324NR	29.9	—	31.42	14.61	16.68	6.36	10.92	S13	50	
GF325NA	45.32	45.81	—	22.4	23.404	6.94	9.93	S18	94.6	
GF325NRA	45.32	45.81	—	22.4	23.404	6.94	9.93	S19	94.6	
GF326NRA	45.32	45.81	—	22.4	23.404	6.94	9.93	S19	99.6	
GF326NA	45.32	45.81	—	22.4	23.404	6.94	9.93	S18	99.6	
GF326NRA	45.32	45.81	—	22.4	23.404	6.94	9.93	S19	99.6	
GNF221A, GNF321A	6.18	6.35	—	4.2	4.56	2.88	3.93	S4	20(10)	
GNF221RA, GNF321RA	6.18	6.35	6.35	4.2	4.56	2.88	3.93	S5	20(10)	
GNF321LA, GNF221LA	8.4	8.56	—	5.08	5.43	2.93	3.95	S4	30(10)	
GNF321LLA, GNF221LLA	9.91	10.07	—	6.06	6.42	3.21	4.24	S24	20(5)	
GNF321RLA, GNF221RLA	8.4	8.56	8.56	5.08	5.43	2.93	3.95	S5	30(10)	
GNF321RLLA, GNF221RLLA	9.91	10.07	10.07	6.06	6.42	3.21	4.24	S23	20(5)	
GNF222A, GNF322A	8.4	8.56	—	5.08	5.43	2.93	3.95	S4	30(10)	
GNF322LA, GNF222LA	9.91	10.07	—	6.06	6.42	3.21	4.24	S24	20(5)	
LNF222RA, LNF221RLA	8.4	8.56	8.56	5.08	5.43	2.93	3.95	S20	30(10)	
GNF322RLA, GNF222RLA	9.91	10.07	10.07	6.06	6.42	3.21	4.24	S23	20(5)	
GNF222RA, GNF322RA	8.4	8.56	8.56	5.08	5.43	2.93	3.95	S5	30(10)	
LNF221RLLA, LNF222RLA	9.91	10.07	—	6.06	6.42	3.21	4.24	S23	20(5)	
GNF323	21.95	23.15	—	9.64	11.7	5.05	8.63	S10	23	
GNF323R	21.95	—	23.46	9.64	11.67	5.05	8.7	S11	24	
GNF324	29.9	31.07	—	14.62	16.68	6.36	10.92	S12	46	
GNF324R	29.9	—	31.42	14.61	16.68	6.36	10.92	S13	47	
GNF325A	33.47	33.96	—	22.4	23.404	6.94	9.93	S18	75	
GNF326A	33.47	33.96	—	22.4	23.404	6.94	9.93	S18	77	
HF221J also HF261J	14.27	17.33	—	6.65	9.02	5.32	10.46	—	13	
HF221N also HF261	14.26	14.60	—	6.64	7.75	4.71	8.89	S6	13	
HF221NR also HF261R	14.34	—	14.91	6.64	7.88	5.00	9.18	S8	14	
HF221S also HF261S	14.27	17.33	—	6.65	9.02	5.32	10.46	—	13	
HF222J also HF262J	16.22	19.31	—	9.17	11.47	5.33	10.46	—	19	
HF222N also HF262	16.26	16.62	—	9.16	10.37	4.71	8.67	S16	18	
HF222NR also HF262R	16.26	—	16.93	9.16	10.41	5.05	9.21	S17	19	
HF222S also HF262S	16.22	19.31	—	9.17	11.47	5.33	10.46	—	19	
HF223J also HF263J	21.96	23.16	—	9.65	12.02	5.34	10.46	—	24	
HF223N also HF263	21.95	23.15	—	9.64	12.01	5.05	10.17	S10	23	
HF223NR also HF263R	21.95	—	23.46	9.64	11.97	5.05	10.17	S11	24	
HF223S also HF263S	21.96	23.16	—	9.65	12.02	5.34	10.46	—	24	
HF224J	29.96	31.07	—	14.62	16.95	6.63	12.58	—	48	
HF224N	29.9	31.07	—	14.62	16.98	6.36	12.33	S12	47	
HF224NR	29.9	—	31.42	14.61	16.99	6.36	12.33	S13	48	
HF224S	29.96	31.07	—	14.62	16.95	6.63	12.58	—	48	
HF225NRA	45.32	45.81	—	22.4	23.404	6.94	9.93	S19	91.1	
HF225NA	45.32	45.81	—	22.4	23.404	6.94	9.93	S18	91.1	
HF226NA	45.32	45.81	—	22.4	23.404	6.94	9.93	S18	95.6	
HF226NRA	45.32	45.81	—	22.4	23.404	6.94	9.93	S19	95.6	
HF227N	66.67	67.16	—	38.4	39.96	9.24	14.68	—	360	
HF227NR	66.67	—	67.74	38.4	39.96	9.24	14.68	—	362	
HF228N	66.67	67.16	—	38.4	39.96	9.24	14.68	—	362	
HF228NR	66.67	—	67.74	38.4	39.96	9.24	14.68	—	364	

*For inches / millimeters conversion, multiply inches by 25.4.

Ⓞ Knocks not provided on Type 4 / 4X and 12 or in 800 & 1200A switches.

Safety Switches

General and Heavy Duty Safety Switches

Dimensions

Safety Switch Dimensions (Inches)* & Shipping Weights

Catalog Number	Height			Width			Depth		Knockout Diagram ^①	Approx. Shipping Weight (lbs.)
	Box A	With Door B	With Rain Shed C	Box D	With Handle E	Box F	With Handle G			
HF261	14.26	14.60	—	6.64	7.75	4.71	8.89	S6	13	
HF261R	14.34	—	14.91	6.64	7.88	5.00	9.18	S8	14	
HF262	16.26	16.62	—	9.16	10.37	4.71	8.67	S16	18	
HF262R	16.26	—	16.93	9.16	10.41	5.05	9.21	S17	19	
HF321J	14.27	17.33	—	6.65	9.02	5.32	10.46	—	14	
HF321N	14.26	14.60	—	6.64	7.75	4.71	8.89	S6	13	
HF321NR	14.34	—	14.91	6.64	7.88	5.00	9.18	S8	14	
HF321S, SS	14.27	17.33	—	6.65	9.02	5.32	10.46	—	14	
HF322J	16.27	19.31	—	9.17	11.47	5.33	10.46	—	20	
HF322N	16.26	16.62	—	9.16	10.37	4.71	8.67	S16	18	
HF322NR	16.26	—	16.93	9.16	10.41	5.05	9.21	S17	19	
HF322S, SS	16.27	19.31	—	9.17	11.47	5.33	10.46	—	20	
HF323J	21.96	23.16	—	9.65	12.02	5.34	10.46	—	25	
HF323N	21.95	23.15	—	9.64	12.01	5.05	10.17	S10	25	
HF323NR	21.95	—	23.46	9.64	11.97	5.05	10.17	S11	26	
HF323S, SS	21.96	23.16	—	9.65	12.02	5.34	10.46	—	25	
HF324J	29.96	31.07	—	14.62	16.95	6.63	12.58	—	49	
HF324N	29.9	31.07	—	14.62	16.98	6.36	12.33	S12	49	
HF324NR	29.9	—	31.42	14.61	16.99	6.36	12.33	S13	50	
HF324S, SS	21.96	31.07	—	14.62	16.95	6.63	12.58	—	49	
HF325JA	45.32	45.81	—	22.4	23.404	6.97	10.05	—	93	
HF325NA	45.32	45.81	—	22.4	23.404	6.94	9.93	S18	94.6	
HF325NRA	45.32	45.81	—	22.4	23.404	6.94	9.93	S19	94.6	
HF325SA	45.32	45.81	—	22.4	23.404	7.34	10.347	—	93	
HF325SSA	45.32	45.81	—	22.4	23.404	7.34	10.347	—	93	
HF326JA	45.32	45.81	—	22.4	23.404	6.97	10.05	—	98	
HF326NA	45.32	45.81	—	22.4	23.404	6.94	9.93	S18	99.6	
HF326NRA	45.32	45.81	—	22.4	23.404	6.94	9.93	S19	99.6	
HF326SA	45.32	45.81	—	22.4	23.404	7.34	10.347	—	98	
HF326SSA	45.32	45.81	—	22.4	23.404	7.34	10.347	—	98	
HF327J	66.67	67.16	—	38.4	39.96	9.24	14.68	—	367	
HF327N	66.67	67.16	—	38.4	39.96	9.24	14.68	—	380	
HF327NR	66.67	—	67.74	38.4	40.25	9.24	14.68	—	383	
HF327S	66.67	67.16	—	38.4	39.96	9.24	14.68	—	367	
HF328N	66.67	67.16	—	38.4	39.96	9.24	14.68	—	382	
HF328NR	66.67	—	67.74	38.4	40.25	9.24	14.68	—	385	
HF361, PV, PVPG	14.26	14.60	—	6.64	7.75	4.71	8.89	S6	13	
HF361J, JW	14.27	17.33	—	6.65	9.02	5.32	10.46	—	14	
HF361L	16.26	17.46	—	9.15	11.53	5.05	10.17	S16	19	
HF361N	14.26	14.60	—	6.64	7.75	4.71	8.89	S6	13	
HF361NR	14.34	—	14.91	6.64	7.88	5.00	9.18	S8	14	
HF361R, RPV, RPVPG	14.34	—	14.91	6.64	7.88	5.00	9.18	S8	14	
HF361RL, RW	16.26	—	16.93	9.16	10.41	5.05	9.21	S17	19	
HF361S, SS, SSW, SW	14.27	17.33	—	6.65	9.02	5.32	10.46	—	15	
HF362, PV, PVPG	16.26	16.62	—	9.16	10.37	4.71	8.67	S16	18	
HF362J, JW	16.27	19.31	—	9.17	11.47	5.33	10.46	—	20	
HF362N	16.26	16.62	—	9.16	10.37	4.71	8.67	S16	18	
HF362NR	16.26	—	16.93	9.16	10.41	5.05	9.21	S17	19	
HF362R, RPV, RPVPG, RW	16.26	—	16.93	9.16	10.41	5.05	9.21	S17	19	
HF362RL	21.95	—	23.46	9.64	11.97	5.05	10.17	S11	25	
HF362S, SS, SSW, SW	16.27	19.31	—	9.17	11.47	5.33	10.46	—	20	
HF363, PV, PVPG	21.95	23.15	—	9.64	12.01	5.05	10.17	S10	24	
HF363J, JW	21.96	23.16	—	9.65	12.02	5.34	10.46	—	25	
HF363N	21.95	23.15	—	9.64	12.01	5.05	10.17	S10	25	
HF363NR	21.95	—	23.46	9.64	11.97	5.05	10.17	S11	26	
HF363R, RPV, RPVPG	21.95	—	23.46	9.64	11.97	5.05	10.17	S11	25	
HF363S, SS, SSW, SW	21.96	23.16	—	9.65	12.02	5.34	10.46	—	25	
HF364, PV, PVPG	29.9	31.07	—	14.62	16.98	6.36	12.33	S12	48	
HF364J, JW	29.96	31.07	—	14.62	16.95	6.63	12.58	—	49	
HF364N	29.9	31.07	—	14.62	16.98	6.36	12.33	S12	49	
HF364NR	29.9	—	31.42	14.61	16.99	6.36	12.33	S13	48	
HF364R, RPV, RPVPG	29.9	—	31.42	14.61	16.99	6.36	12.33	S13	49	
HF364S, SS, SSW, SW	29.96	31.07	—	14.62	16.95	6.63	12.58	—	49	
HF365A	45.32	45.81	—	22.4	23.404	6.94	9.93	S18	93	
HF365JA, JWA	45.32	45.81	—	22.4	23.404	6.97	10.05	—	93	

*For inches / millimeters conversion, multiply inches by 25.4.

① Knocks not provided on Type 4 / 4X and 12 or in 800 & 1200A switches.

Safety Switches

General and Heavy Duty Safety Switches

Dimensions

Safety Switch Dimensions (Inches)* & Shipping Weights

Catalog Number	Height			Width			Depth		Knockout Diagram ^①	Approx. Shipping Weight (lbs.)
	Box A	With Door B	With Rain Shed C	Box D	With Handle E	Box F	With Handle G			
HF365NA	45.32	45.81	—	22.4	23.404	6.94	9.93	S18	94.6	
HF365NRA	45.32	45.81	—	22.4	23.404	6.94	9.93	S19	94.6	
HF365RA	45.32	45.81	—	22.4	23.404	6.94	9.93	S19	93	
HF365SA, SS, SWA, SSWA	45.32	45.81	—	22.4	23.404	7.34	10.347	—	93	
HF366A	45.32	45.81	—	22.4	23.404	6.94	9.93	S18	98	
HF366JA, JWA	45.32	45.81	—	22.4	23.404	6.97	10.05	—	98	
HF366NA	45.32	45.81	—	22.4	23.404	6.94	9.93	S18	99.6	
HF366NRA	45.32	45.81	—	22.4	23.404	6.94	9.93	S19	99.6	
HF366RA	45.32	45.81	—	22.4	23.404	6.94	9.93	S19	98	
HF366SA, SSA	45.32	45.81	—	22.4	23.404	7.34	10.347	—	98	
HF367	66.67	67.16	—	38.4	39.96	9.24	14.68	—	380	
HF367J, JW	66.67	67.16	—	38.4	39.96	9.24	14.68	—	380	
HF367N	66.67	67.16	—	38.4	39.96	9.24	14.68	—	382	
HF367NR	66.67	—	67.74	38.4	40.25	9.24	14.68	—	386	
HF367R, RW	66.67	—	67.74	38.4	40.25	9.24	14.68	—	382	
HF367S, SW	66.67	67.16	—	38.4	39.96	9.24	14.68	—	380	
HF368, J, S, JW, SW	66.67	67.16	—	38.4	39.96	9.24	14.68	—	383	
HF368N	66.67	67.16	—	38.4	39.96	9.24	14.68	—	385	
HF368NR	66.67	—	67.74	38.4	40.25	9.24	14.68	—	388	
HF368R, RW	66.67	—	67.74	38.4	40.25	9.24	14.68	—	385	
HFC221N	14.26	14.6	—	6.64	7.75	4.71	8.89	S6	13	
HFC221NR	14.34	—	14.91	6.64	7.88	5	9.18	S8	14	
HFC222N	16.26	16.62	—	9.16	10.37	4.71	8.67	S16	18	
HFC222NR	16.26	—	16.93	9.16	10.41	5.05	9.21	S17	19	
HFC261	14.26	14.6	—	6.64	7.75	4.71	8.89	S6	13	
HFC261R	14.34	—	14.91	6.64	7.88	5	9.18	S8	14	
HFC262	16.26	16.62	—	9.16	10.37	4.71	8.67	S16	18	
HFC262R	16.26	—	16.93	9.16	10.41	5.05	9.21	S17	19	
HFC321N	14.26	14.6	—	6.64	7.75	4.71	8.89	S6	13	
HFC321NR	14.34	—	14.91	6.64	7.88	5	9.18	S8	14	
HFC322N	16.26	16.62	—	9.16	10.37	4.71	8.67	S16	18	
HFC322NR	16.26	—	16.93	9.16	10.41	5.05	9.21	S17	19	
HFC361	14.26	14.6	—	6.64	7.75	4.71	8.89	S6	13	
HFC361N	14.26	14.6	—	6.64	7.75	4.71	8.89	S6	13	
HFC361NR	14.34	—	14.91	6.64	7.88	5	9.18	S8	14	
HFC361R	14.34	—	14.91	6.64	7.88	5	9.18	S8	14	
HFC362	16.26	16.62	—	9.16	10.37	4.71	8.67	S16	18	
HFC362N	16.26	16.62	—	9.16	10.37	4.71	8.67	S16	18	
HFC362NR	16.26	—	16.93	9.16	10.41	5.05	9.21	S17	19	
HFC362R	16.26	—	16.93	9.16	10.41	5.05	9.21	S17	19	
HNF365JA, JWA	45.32	45.81	—	22.4	23.404	6.97	10.05	—	75	
HNF365RA	33.47	33.96	—	22.4	23.404	6.94	9.93	S19	75	
HNF365SA, SSA, SWA, SSWA	33.47	33.96	—	22.4	23.404	7.34	10.347	—	75	
HNF366SA, SSA	33.47	33.96	—	22.4	23.404	7.34	10.347	—	77	
HNF366JA, JWA	45.32	45.81	—	22.4	23.404	6.97	10.05	—	77	
HNF366RA	33.47	33.96	—	22.4	23.404	6.94	9.93	S19	77	
HNF361, PV, PVPG also HNF261 & HNF362H, HNFC261, HNFC361	11.11	11.45	—	6.64	7.72	4.7	9.15	S7	11	
HNF361J, JW also HNF261J & HNF362JH	11.12	14.14	—	6.65	9.02	5.56	10.46	—	13	
HNF361R, RPV, RPVPG also HNF261R & HNF362RH, HNFC261R, HNFC361R	11.09	—	11.76	6.64	7.88	5	8.91	S9	12	
HNF361RL, HNF362R, RPV, RPVPG also HNF262R, HNFC262R, HNFC362R	16.26	—	16.93	9.16	10.41	5.05	9.14	S17	18	
HNF361S, SS, SSW, SW also HNF261S & HNF362SH	11.12	14.14	—	6.65	9.02	5.56	10.46	—	13	
HNF362, PV, PVPG also HNF262, HNFC262, HNFC362	16.26	16.62	—	9.16	10.26	4.71	9.04	S16	17	
HNF362J, JW also HNF262J	16.27	17.46	—	9.17	11.47	5.33	10.46	—	19	
HNF362RL, HNFC262R, HNFC362R	21.95	—	23.46	9.64	11.97	5.05	10.17	S11	24	
HNF362S, SS, SSW, SW also HNF262S	16.27	17.46	—	9.17	11.47	5.33	10.46	—	19	
HNF363, PV, PVPG also HNF263	21.95	23.15	—	9.64	12.01	5.05	10.17	S10	23	
HNF363J, JW also HNF263J	21.96	23.16	—	9.65	12.02	5.34	10.46	—	24	
HNF363R, RPV, RPVPG also HNF263R	21.95	—	23.46	9.64	11.97	5.05	10.17	S11	24	
HNF363S, SS, SSW, SW also HNF263S	21.96	23.16	—	9.65	12.02	5.34	10.46	—	24	
HNF364, PV, PVPG	29.9	31.07	—	14.62	16.98	6.36	12.33	S12	46	
HNF364J, JW	29.96	31.07	—	14.62	16.95	6.63	12.58	—	47	

*For inches / millimeters conversion, multiply inches by 25.4.

① Knocks not provided on Type 4 / 4X and 12 or in 800 & 1200A switches.

Safety Switch Dimensions (Inches)* & Shipping Weights

Catalog Number	Height			Width		Depth		Knockout Diagram ^①	Approx. Shipping Weight (lbs.)
	Box A	With Door B	With Rain Shed C	Box D	With Handle E	Box F	With Handle G		
HN364R, RPV, RPVPG	29.9	—	31.42	14.61	16.99	6.36	12.33	S13	47
HN364S, SS, SSW, SW	29.96	31.07	—	14.62	16.95	6.63	12.58	—	47
HN365JA, JWA	45.32	45.81	—	22.4	23.404	6.97	10.05	—	75
HN365RA	33.47	33.96	—	22.4	23.404	6.94	9.93	S19	75
HN365SA, SSA, SWA, SSWA	33.47	33.96	—	22.4	23.404	7.34	10.347	—	75
HN366JA, JWA	45.32	45.81	—	22.4	23.404	6.97	10.05	—	77
HN366RA	33.47	33.96	—	22.4	23.404	6.94	9.93	S19	77
HN366SA	33.47	33.96	—	22.4	23.404	7.34	10.347	—	77
HN367, J, JWA	54.67	55.16	—	38.4	39.96	9.24	14.68	—	302
HN367R, RW	54.67	—	55.7	38.4	40.25	9.24	14.68	—	304
HN367S, SW	54.67	55.16	—	38.4	39.96	9.24	14.68	—	302
HN368, J, S, SW, JW	54.67	55.16	—	38.4	39.96	9.24	14.68	—	305
HN368R, RW	54.67	55.16	—	38.4	40.25	9.24	14.68	—	307
LF111N	7.97	8.13	—	5.5	5.94	3	5.38	S2	35 (10)
LF111NR	8.07	—	8.16	5.16	5.94	3.13	5.38	S3	35 (10)
LF211N	7.97	8.13	—	5.5	5.94	3	5.38	S1	35 (10)
LF211NR	8.07	—	8.16	5.16	5.94	3.13	5.38	S3	35 (10)
US2:HF361PV	14.26	14.6	—	6.64	7.75	4.71	8.89	S6	13
US2:HF361PVPG	14.26	14.6	—	6.64	7.75	4.71	8.89	S6	13
US2:HF361RPV	14.34	—	14.91	6.64	7.88	5	9.18	S8	14
US2:HF361RPVPG	14.34	—	14.91	6.64	7.88	5	9.18	S8	14
US2:HF362PV	16.26	16.62	—	9.16	10.37	4.71	8.67	S16	18
US2:HF362PVPG	16.26	16.62	—	9.16	10.37	4.71	8.67	S16	18
US2:HF362RPV	16.26	—	16.93	9.16	10.41	5.05	9.21	S17	19
US2:HF362RPVPG	16.26	—	16.93	9.16	10.41	5.05	9.21	S17	19
US2:HN361PV	11.11	11.45	—	6.64	7.72	4.7	9.15	S7	11
US2:HN361PVPG	11.11	11.45	—	6.64	7.72	4.7	9.15	S7	11
US2:HN361RPV	11.09	—	11.76	6.64	7.88	5	8.91	S9	12
US2:HN361RPVPG	11.09	—	11.76	6.64	7.88	5	8.91	S9	12
US2:HN362PV	16.26	16.62	—	9.16	10.26	4.71	9.04	S16	17
US2:HN362PVPG	16.26	16.62	—	9.16	10.26	4.71	9.04	S16	17
US2:HN362RPV	16.26	—	16.93	9.16	10.41	5.05	9.14	S17	18
US2:HN362RPVPG	16.26	—	16.93	9.16	10.41	5.05	9.14	S17	18

Type 1 or 3R
30-60A GD

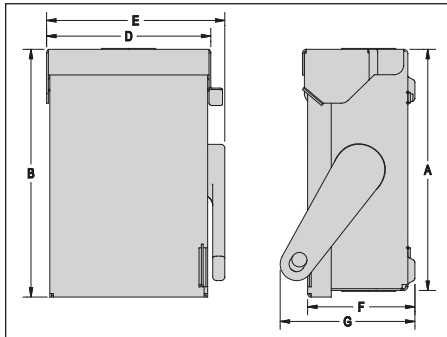

Type 1 or 3R
100-200A GD, 30-200A HD Type VBII

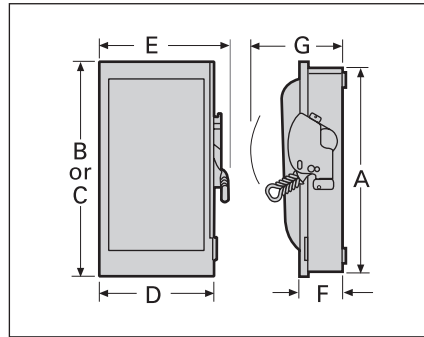

Type 4/4X or 12
30-200A HD Type VBII

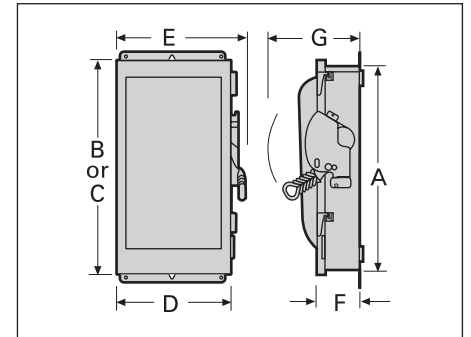

Type 1 or 3R
400-1200A Type VBII (GD & HD)

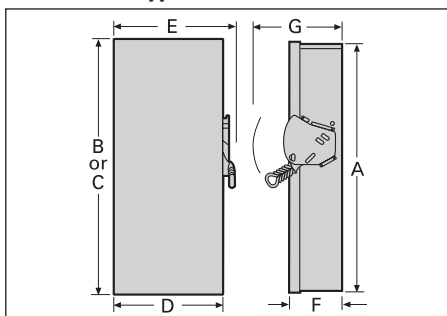

Type 4/4X or 12
400-1200A HD Type VBII

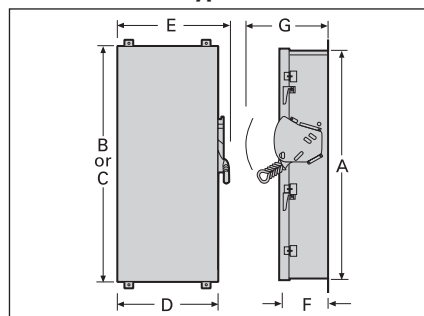

*For inches / millimeters conversion, multiply inches by 25.4.

① Knocks not provided on Type 4 / 4X and 12 or in 800 & 1200A switches.

Safety Switches

General and Heavy Duty Safety Switches

Knockout Diagrams

Type 1 & 3R Enclosures

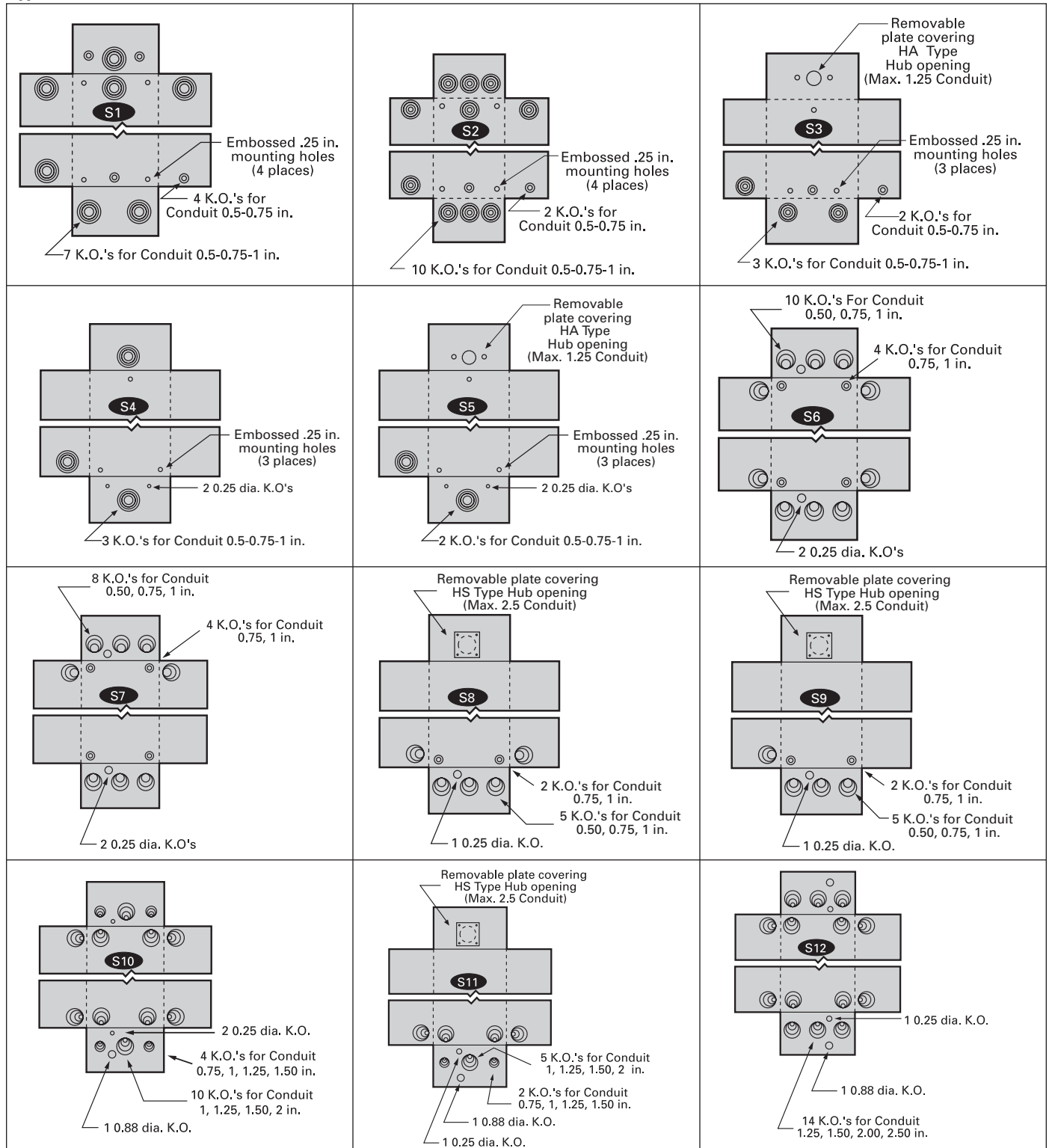

*For inches / millimeters conversion, multiply inches by 25.4.

Safety Switches

General and Heavy Duty Safety Switches

Knockout Diagrams

Type 1 & 3R Enclosures

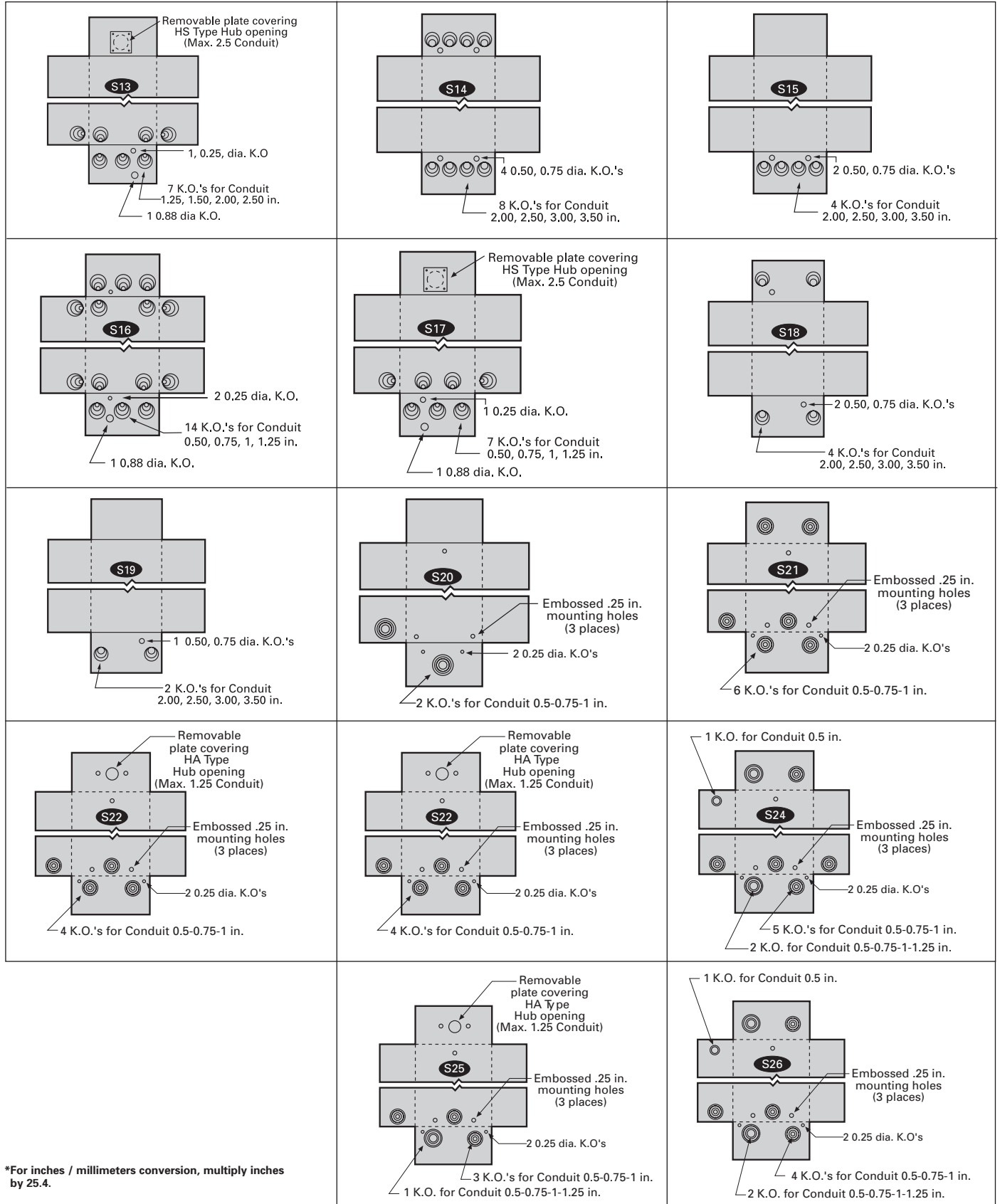

*For inches / millimeters conversion, multiply inches by 25.4.

Safety Switches

Special Application: Non-Metallic

Dimensions

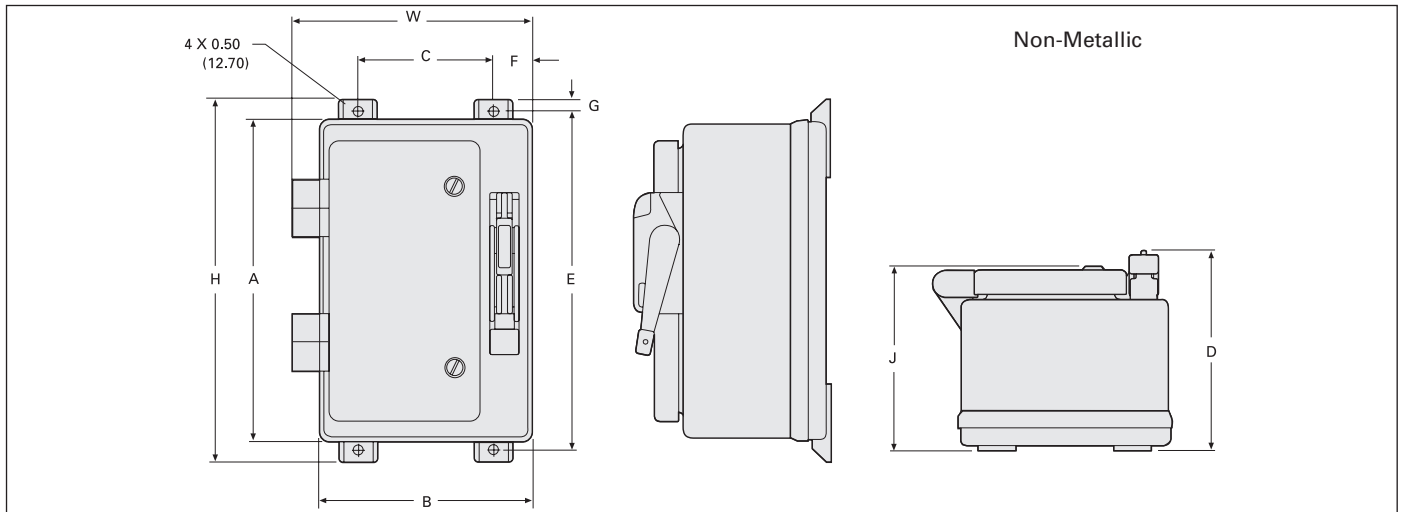

Catalog Number	Dimensions (Inches) Non-Metallic									
	H	W	D	A	B	C	E	F	G	J
HF321NX	18.75	12.11	10.25	16.59	10.97	7.00	17.50	1.98	.46	9.20
HF322NX	18.75	12.11	10.25	16.59	10.97	7.00	17.50	1.98	.46	9.20
HF361NX ^⓪	18.75	12.11	10.25	16.59	10.97	7.00	17.50	1.98	.46	9.20
HF362NX ^⓪	18.75	12.11	10.25	16.59	10.97	7.00	17.50	1.98	.46	9.20
HF363NX ^⓪	26.95	14.87	13.25	24.84	13.72	6.25	25.75	3.75	.46	12.15
HF364NX ^⓪	33.41	27.47	13.19	31.31	26.31	18.50	32.25	3.91	.47	12.10
HNF361X ^⓪	18.75	12.11	10.25	16.59	10.97	7.00	17.50	1.98	.46	9.20
HNF362X ^⓪	18.75	12.11	10.25	16.59	10.97	7.00	17.50	1.98	.46	9.20
HNF363X ^⓪	26.95	14.87	13.25	24.84	13.72	6.25	25.75	3.75	.46	12.15
HNF364X ^⓪	33.41	27.47	13.19	31.31	26.31	18.50	32.25	3.91	.47	12.10

VBI Interlocked Receptacle Switches

Ampere Rating	Dimensions (Inches)						
	A	B	C	D	E	F	G

Cr-H Type Fusible (240 & 600V)

30	14.27	7.42	9.02	6.22	1.52	6.1	6.0
60	16.27	9.17	11.47	6.34	1.52	6.4	7.4
100	21.96	9.65	12.02	6.80	1.52	6.5	7.6

Cr-H Type Non-Fusible (600V max.)

30	14.27	7.42	9.02	6.22	1.52	6.1	6.0
60	16.27	9.17	11.47	6.34	1.52	6.4	7.4
100	21.96	9.65	12.02	6.80	1.52	6.5	7.6

Pyle-National Type Fusible (240 & 600V)

30	14.27	7.42	9.02	6.22	1.52	3.5	3.0
60	16.27	9.17	11.47	6.34	1.52	5.0	4.5

Pyle-National Type Non-Fusible (600V max.)

30	14.27	7.42	9.02 ^⓪	6.22	1.52	3.5	3.0
60	16.27	9.17	11.47 ^⓪	6.34	1.52	5.0	4.5

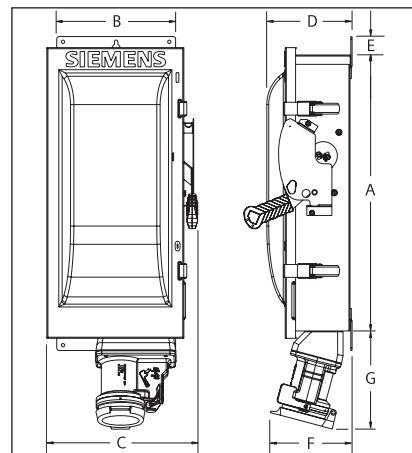

*For inches / millimeters conversion, multiply inches by 25.4.

^⓪ Dimensions also apply to "L" suffix switches (less lugs).

4 & 6-Pole Safety Switch Dimensions – Inches (mm)

Catalog Number	Enclosure			Mounting		
	A	B	C	D	E	F

Figure 1, 4-Pole Fusible and Non-fusible, Type 1

HNF461	24.50 (622)	9.53 (242)	6.09 (155)	19.00 (483)	6.75 (171)	0.268 (7)
HF461	29.12 (740)	9.53 (242)	6.09 (155)	23.50 (597)	6.75 (171)	0.268 (7)
HNF462	24.88 (632)	11.50 (292)	6.09 (155)	19.00 (483)	9.38 (238)	0.268 (7)
HF462	33.53 (852)	11.50 (292)	6.09 (155)	27.50 (699)	9.38 (238)	0.268 (7)
HNF463	27.62 (702)	12.18 (309)	6.09 (155)	19.36 (492)	8.00 (203)	0.268 (7)
HF463	36.44 (926)	12.18 (309)	6.09 (155)	28.11 (714)	8.00 (203)	0.268 (7)
HNF464	36.00 (914)	19.12 (486)	6.42 (163)	30.88 (784)	15.00 (381)	0.44 (11)
HF464	49.48 (1257)	19.12 (486)	6.42 (163)	45.50 (1130)	15.00 (381)	0.44 (11)

Figure 2, 4 & 6-Pole Fusible Type 12/3R and 4X

HF461J, HF661J, HF661S	29.50 (622)	9.53 (242)	6.48 (165)	31.65 (804)	5.47 (139)	0.27 (7)
HF462J, HF662J, HF662S	33.53 (852)	11.50 (292)	6.48 (165)	35.69 (907)	8.00 (203)	0.27 (7)
HF463J, HF663J, HF663S	36.44 (926)	12.18 (309)	6.48 (165)	38.67 (982)	8.47 (215)	0.27 (7)
HF464J, HF664J, HF664S	49.48 (1257)	19.12 (486)	6.78 (172)	51.64 (1312)	13.44 (341)	0.33 (8)

Figure 2, 4 & 6-Pole Non-fusible Type 12/3R and 4X

HNF461J, HNF661J, HNF661S	24.50 (622)	9.53 (242)	6.48 (165)	26.65 (667)	5.47 (139)	0.27 (7)
HNF462J, HNF662J, HNF662S	24.88 (632)	11.50 (292)	6.48 (165)	27.03 (687)	8.00 (203)	0.27 (7)
HNF463J, HNF663J, HNF663S	27.54 (700)	12.18 (309)	6.48 (165)	29.77 (756)	8.47 (215)	0.27 (7)
HNF464J, HNF664J, HNF664S	36.00 (914)	19.12 (486)	6.78 (172)	38.16 (969)	13.44 (341)	0.33 (8)

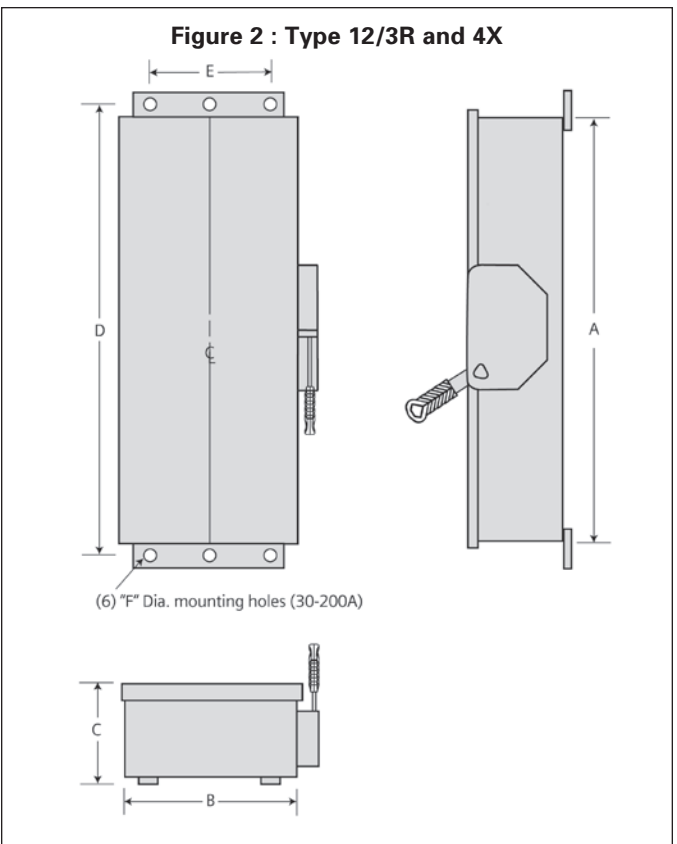
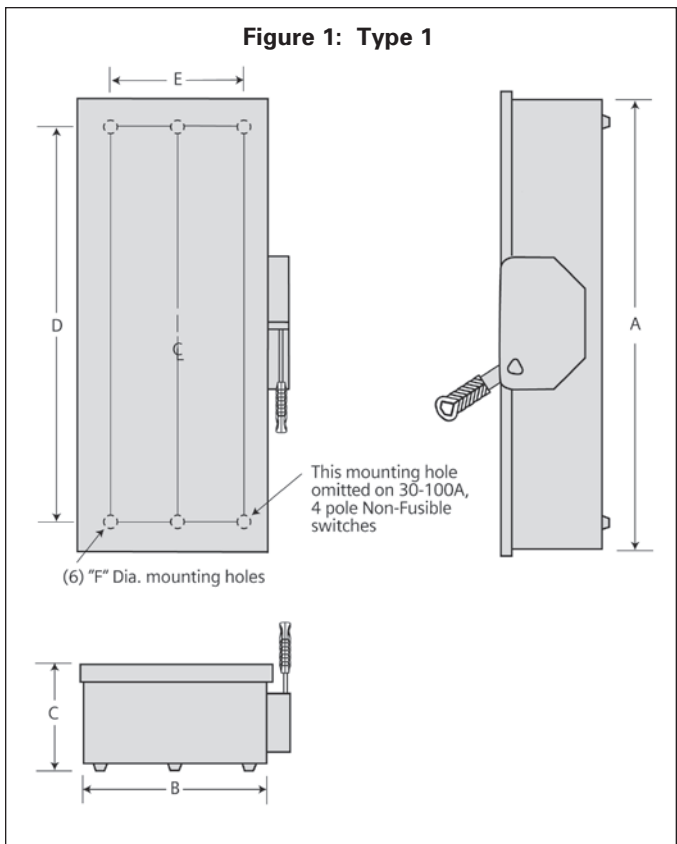

Double Throw

Description and Selection

Description

Double throw switches are intended to transfer loads from one power source to another. All 2 & 3-pole double throw switches are suitable for use as service equipment including non-fusible versions when used in combination with a UL listed circuit breaker or fusible switch. All are UL Listed and both horsepower and load break rated. Switches are rated for use on systems up to 10,000A when protected with Class H fuses or 100,000A when protected with Class R or Class T fuses^②. They can also be used to connect a single source of power to either of two loads. In this application it is necessary to field modify fusible

switches so that the fuses are on the load side of the switching mechanism.

A cover interlock is provided on all ampere ratings. The operating handle may be padlocked in the off position.

Fuse Capabilities of Fusible DTF Switches

Amp Rating	Fuse Type			
	H	R	T	J
30 & 60A, 240V	Std	Yes (kit)	No	No
30 & 60A, 600V	Std	Yes (kit)	No	Yes ^③
100 & 200A	Std	Yes (kit)	Yes (kit)	Yes ^③
400 & 600A (DTF)	No	No	Yes ^③	Std

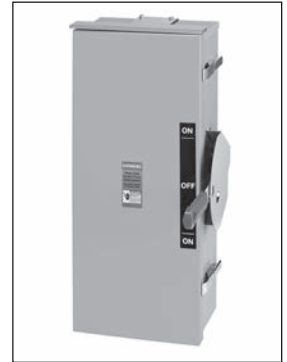

Double Throw Switches

System	Voltage	Number of Poles	Amps	Type 1 — Indoor	Type 3R — Outdoor ^①	Type 12/3R — Industrial	Type 4X — Stainless Steel
				Catalog Number	Catalog Number	Catalog Number	Catalog Number

Heavy Duty Fusible (30-200A) with Class H fuse spacings —Less Neutral^②

	240 Volt AC or 250 Volt DC	2	200	DTF224▲	DTF224R	—	—	
			3	30	DTF321	DTF321R▲	—	—
				60	DTF322	DTF322R▲	—	—
		100		DTF323▲	DTF323R	—	—	
		3	200	DTF324	DTF324R	—	—	
			400	DTF325	FR325DTK ^④ ▲	—	—	
	600		DTF326▲	FR326DTK ^④ ▲	—	—		
	600 Volt AC, 250 Volt DC	3	30	DTF361	—	—	—	
			60	DTF362▲	—	—	—	
			100	DTF363	DTF363R	—	F353SSDTK ^⑤ ▲	
		200	DTF364	DTF364R	—	F354SSDTK ^⑤ ▲		
		400	DTF365	FR355DTK ^④ ▲	—	F355SSDTK ^④ ▲		
400		DTF365	FR355DTK ^④ ▲	—	F355SSDTK ^④ ▲			

Heavy Duty Non-Fusible —Less Neutral^②

	240 Volt AC or 250 Volt DC	2	30	DTNF221	—	—	—	
			3	60	DTNF222	—	—	—
				100	DTNF223	—	—	—
		200		DTNF224	DTNF224R	—	—	
		3	400	DTNF225	DTNF225R	—	—	
			30	DTNF321	—	—	—	
	60		DTNF322	—	—	—		
	600 Volt AC, or 250 Volt DC	3	100	DTNF323	DTNF323R	—	—	
			200	DTNF324	DTNF324R	—	—	
			400	DTNF325	—	—	—	
		600	DTNF326	—	—	—		
		800	DTNF327▲	—	—	—		
		3	30	DTNF361	DTNF361R	DTNF361J	DTNF361S	
	60		DTNF362	DTNF362R	DTNF362J	DTNF362S		
	100		DTNF363	DTNF363R	DTNF363J	DTNF363S		
	200		DTNF364	DTNF364R	DTNF364J▲	DTNF364S		
	400		DTNF365	DTNF365R	NF355HDTK	NF355SSDTK		
	600		DTNF366	DTNF366R	—	—		
4 ^⑤	800	DTNF367	DTNF367R	—	—			
	1200	DTNF368▲	DTNF368R	—	—			
	30	—	NFR451DTK▲	—	—			
	60	—	NFR452DTK▲	—	—			
	100	—	NFR453DTK▲	—	—			
	200	NF454DTK	NFR454DTK▲	—	NF454SSDTK▲			
400	NF455DTK▲	NFR455DTK▲	—	—				
600	NF456DTK▲	NFR456DTK▲	—	—				
800	NF457DTK▲	NFR457DTK▲	—	—				

General Duty Non-Fusible

	Voltage	Number of Poles	Amps	Type 3R — Outdoor ^① Less Neutral	Type 3R — Outdoor ^① With Neutral	Type 3R — Outdoor General Duty With Neutral ^②
				Catalog Number	Catalog Number	Catalog Number
	240 Volt AC	2	100	DTGNF223R	DTGNF223NR	DTLNF213NR
			200	DTGNF224R	DTGNF224NR	—
	3	100	DTGNF323R	DTGNF323NR	—	
		200	DTGNF324R	DTGNF324NR	—	

▲ Built to order. Allow 3-4 weeks for delivery.

① Use HS Type hubs for 30-200A switches. 400A and larger switches do not have hub provisions.
 ② All Heavy Duty double throw switches with a catalog number starting with "DT" are rated 200,000 AIC max.

when protected by Class R, J or T fuses. Fuse ampere rating must not exceed switch ampere rating.
 ③ Move load base.
 ④ Will accept class T Fuses only.
 ⑤ 4-pole switches are not approved for service entrance.

⑥ Will accept class H fuses only.
 ⑦ General duty Stand-by Power Panel catalog number DTLNF213NR contains (2) 100A, 2P circuit breakers rated 120/240V AC & 10,000 AIC.

Accessories, Lug Data and Horsepower Ratings

Accessories – 2 and 3-Pole Switches Type “DT” Only[Ⓞ]

Description		Catalog Number
Neutral Kits	30A 60 & 100A 200A 400 & 600A 800 & 1200A	HNC612 HN263 HNC264 HN678 HND678
	30-200A (2) #14-4 AWG 400 & 600A (4) #14-2/0 800-1200A (8) #6-350 Kcmil	HG61234 HG656 HG678
Auxiliary Contacts (HD only) (two required per switch) [Ⓞ]	30-200A with (1) NO & (1) NC contact 30-200A with (2) NO & (2) NC contacts 400-1200A with (1) NO & (1) NC contact 400-1200A with (2) NO & (2) NC contacts	HA161234 HA261234 HA165678 HA265678
Class R Fuse Clip Kits (two required per switch)	30A, 240V Kit 30A, 600V Kit/60A, 240V Kit 60A, 600V Kit 100A Kit 200A Kit	HR21 HR612 HR62 HR63 HR64
Class T Fuse Adapter Kits (two required per pole)	100A, 240V Kit 100A, 600V Kit 200A, 240V Kit 200A, 600V Kit	HT23 HT63 HT24 HT64
Type 3R Hubs (30-200A)	For ¾" Conduit For 1" Conduit For 1 ½" Conduit For 1 ½" Conduit For 2" Conduit For 2 ½" Conduit	ECHS075 ECHS100 ECHS125 ECHS150 ECHS200 ECHS250

Accessories – 4-Pole and Type “F” & “NF” 3-Pole Switches Only[Ⓞ]

Description		Catalog Number
Auxiliary Switch (two required per switch)	30-800A (1) NO, (1) NC [Ⓞ] (2) NO, (2) NC [Ⓞ]	DS200EK1 DS200EK2
Ground Lug Kit [Ⓞ]	30-60-100A 200A 400-600-800A	DS100GK DS200GK DS468GK
Hubs	30-60-100A Use Type HR Hubs 200-400A Use Type SSH 4, 4X Hubs 600-800A Use Type SSH 4, 4X Hubs	
Neutrals (3-pole only)	30-60-100A 200A 400 & 600A Fusible 400A 3P Non-Fusible	DT100NK DT200NK DS800NK DT600NK

Maximum Horsepower Ratings

Fused

Ampere Rating	1-Phase AC		3-Phase AC			250V DC
	240V	240V	240V	480V	600V	
30	3	7½	15	20	5	
60	10	15	30	50	10	
100	15	30	60	75	20	
200	15	60	125	150	40	
400	—	125	125	125	50	
600	—	125	—	—	50	

Non-Fused

30	5	10	20	30	5
60	10	20	50	60	10
100	15	40	75	100	20
200	15	60	125	150	40
400-800	—	125	250	350	50

▲ Built to order. Allow 6-8 weeks for delivery.

Ⓞ For “DT” VBII Type switches only.

Ⓞ Also for fusible stainless & 400A Type 12 & 4x switches.

Ⓞ The following ground lugs are provided as standard in 200A and larger switches 200-(1) #14-4 Cu/Al 400-800A-(3) #6-250MCM Cu/Al.

Ⓞ One aux. required for normal and one required for emergency switch line base.

Wire Ranges (Line, Load and Neutral) per NEC Requirements

30-200A – 2, 3 & 4-Pole Switches

Switch Ampere Rating	Wire Range (Cu/Al) New VBII Design Line, Load and Neutral
30	(1) #14-6
60	(1) #14-2
100	(1) #14-1/0 AWG
100	(1) #14-1/0 AWG
200	(1) #6-250 kcmil

400-1200A – 2 & 3-Pole Switches

Switch Ampere Rating	Wire Range (Cu/Al) New VBII Design Line, Load and Neutral
400	(1) 1/0 AWG-750 kcmil or (2) 1/0 AWG-250 kcmil
600	(2) 1/0 AWG-500 kcmil
800	(2) 1/0 AWG-750 kcmil or (3) 1/0 AWG-500 kcmil
1200	(3) 1/0 AWG-600 kcmil or (4) 1/0 AWG-500 kcmil

400-800A – 4-Pole switches

Switch Ampere Rating	Wire Range (Cu/Al) New VBII Design Line, Load and Neutral
400	(2) 1/0 AWG-300 kcmil or (1) 1/0 AWG-750 kcmil
600	(2) 250-500 Kcmil
800	(3) 250-500 Kcmil

Replacement Parts – 2 and 3-Pole Switches Only[Ⓞ]

Description		Catalog Number
Type 1, 3R & 12 Replacement Handle	30-200A	HHD61234
Type 4X Replacement Handle	30-200A	HHD61234S
Replacement Handle	400-1200A	HHD656

VIII Design Double Throw Dimensions (Inches)

Catalog Number	Enclosure			Mounting		
	A	B	C	D	E	F
Figure 1 (30-1200A Type 1 & 3R)						
DTNF221, DTNF321, DTNF361, DTNF361R	24.50	9.53	6.09	19.00	6.75	0.268
DTF321, DTF321R, DTF361	29.12	9.53	6.09	23.50	6.75	0.268
DTNF222, DTNF322, DTNF362, DTNF362R	24.88	11.50	6.09	19.00	9.38	0.268
DTF322, DTF322R, DTF362	33.45	11.50	6.09	27.50	9.38	0.268
DTNF223, DTNF323, DTNF323R, DTNF363, DTNF363R, DTGNF223R, DTGNF223NR, DTGNF323R, DTGNF323NR	27.62	12.18	6.09	19.36	8.00	0.268
DTF323, DTF323R, DTF363, DTF363R	36.44	12.18	6.09	28.11	8.00	0.268
DTNF224, DTNF224R, DTNF324, DTNF324R, DTNF364, DTNF364R, DTGNF224R, DTGNF224NR, DTGNF324R, DTGNF324NR	36.00	19.12	6.42	31.00	15.00	0.44
DTF224, DTF224R, DTF324, DTF324R, DTF364, DTF364R	49.44	19.12	6.42	44.50	15.00	0.44
DTF325, DTF326, DTF365	73.54	28.22	9.44	65.50	16.00	0.56
DTNF225, DTNF225R, DTNF325, DTNF365, DTNF365R	57.71	28.22	9.44	49.75	16.00	0.56
DTNF326, DTNF366, DTNF366R	57.71	28.22	9.44	49.75	16.00	0.56
DTNF327, DTNF367, DTNF367R	71.65	41.60	9.44	63.70	32.00	0.56
DTNF368, DTNF368R	71.65	41.60	9.44	63.70	32.00	0.56
FR325DTK [Ⓢ] , FR355DTK [Ⓢ]	74.31	24.90	8.88	69.50	20.25	0.56
FR326DTK [Ⓢ]	85.65	27.00	8.88	80.75	22.25	0.56
NFR451DTK [Ⓢ] , NFR452DTK [Ⓢ] , NFR453DTK [Ⓢ]	24.63	17.34	4.78	21.50	14.97 [Ⓣ]	0.27 [Ⓣ]
NF454DTK [Ⓢ] , NFR454DTK [Ⓢ]	37.25	19.19	6.32	33.50	16.00 [Ⓢ]	0.56 [Ⓢ]
NF455DTK [Ⓢ] , NF456DTK [Ⓢ] , NF457DTK [Ⓢ] , NFR455DTK [Ⓢ] , NFR456DTK [Ⓢ] , NFR457DTK [Ⓢ]	63.31	27.00	8.88	58.50	22.25 [Ⓢ]	0.56 [Ⓢ]
Figure 2 (30-200A Type 12 & 4X)						
DTNF361J, DTNF361S	24.42	9.65	6.48	26.65	5.47	0.27
DTNF362J, DTNF362S	24.80	11.61	6.48	27.03	8.00	0.27
DTNF363J, DTNF363S	27.54	12.29	6.48	29.77	8.47	0.27
DTNF364J, DTNF364S	35.93	19.24	6.78	38.16	13.44	0.33
NF355HDTK [Ⓢ] , NF355SSDTK [Ⓢ]	53.82	22.66	7.25	56.20	18.00	0.56
NF454SSDTK [Ⓢ]	37.47	19.16	6.48	39.75	15.75	0.50 [Ⓢ]
F353SSDTK [Ⓢ]	37.00	11.62	5.50	38.50	9.00	0.26
F354SSDTK [Ⓢ]	50.90	19.16	6.46	53.27	16.12	0.50
F355SSDTK [Ⓢ]	74.50	25.00	8.92	76.69	20.25	0.56

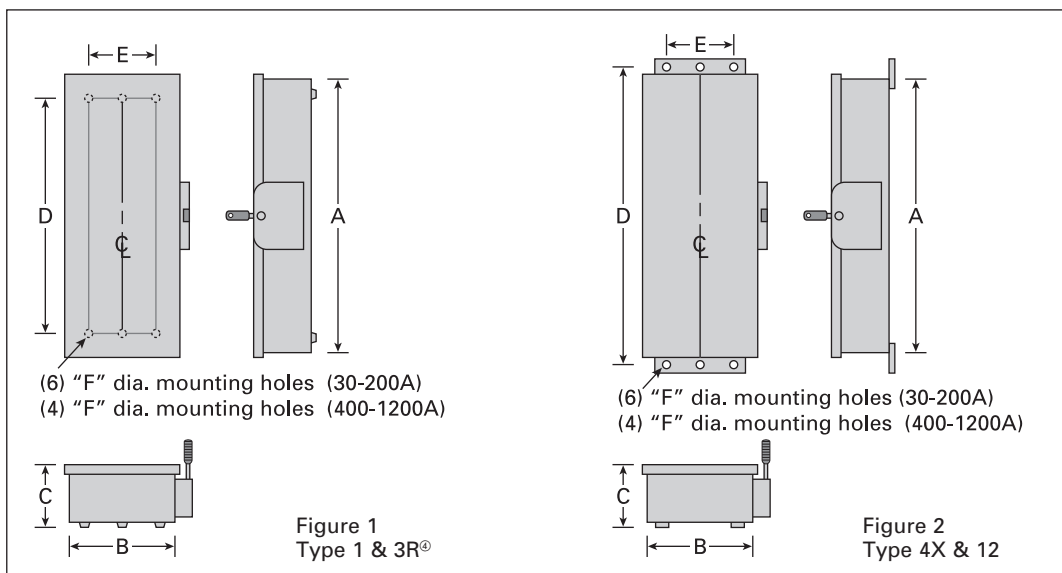

*For inches / millimeters conversion, multiply inches by 25.4.

Ⓢ (3) Mounting holes supplied (1 at top).
 Ⓢ (4) Mounting holes provided.

Ⓢ These switches are not Type VIII design.
 Ⓢ Drip hood not shown but provided on Type 3R enclosures.

Safety Switches

Enclosed Bolted Pressure Switches & Safety Switch

Replacement Parts

For enclosed bolted pressure contact switches order as lug-in/lug-out single section BPS main switchboards using either the SPACE 2000 Switchboard EPM or COMPAS.

VBII Safety Switch Replacement Parts

Ampere Rating	Line Base	Load Base	Handle / Handle Guard	
	Catalog Number	Catalog Number	General Duty	Heavy Duty

Fusible 2- and 3-Pole 60-600A General Duty & 30-1200A Heavy Duty^{⑤⑧}

30 HD 240V	HFB21 ^②	HBB21 ^②	—	HH6123 ^⑦
60 GD	HFB612 ^②	HBB612 ^②	GH223	—
60 HD 240V	HFB22 ^②	HBB22 ^②	—	HH6123 ^⑦
30 600V	HFB612 ^②	HBB612 ^②	—	HH6123 ^⑦
60 600V	HFB62 ^②	HBB62 ^②	—	HH6123 ^⑦
100	HFB63 ^②	HBB63 ^②	GH223	HH6123 ^⑦
200	HFB64 ^②	HBB64 ^②	GH24	HH64 ^⑦
400 (Legacy)	HFB65 ^{③④}	HBB656 ^{③④}	HH65678	HH65678 ^⑦
400 (Series-A)	HFB65AB	HBB656AB	HH656A	HH656A
600 (Legacy)	HFB66 ^{③④}	HBB656 ^{③④}	HH65678	HH65678 ^⑦
600 (Series-A)	HFB66AB	HBB656AB	HH656A	HH656A
800	HFB67A ^{②⑥}	HBB67A ^{②⑥}	—	HH65678 ^⑦
1200	HFB68 ^{②⑥}	HBB68 ^{②⑥}	—	HH68 ^⑦

Non-Fusible 3-Pole 60-600A General Duty & 30-1200A Heavy Duty^{⑤⑧}

30 HD	HNB612 ^②	—	—	HH6123 ^⑦
60 GD	HNB612 ^②	—	GH223	—
60 HD	HNB623 ^②	—	—	HH6123 ^⑦
100	HNB623 ^②	—	GH223	HH6123 ^⑦
200	HNB64 ^②	—	GH24	HH64 ^⑦
400 (Legacy)	HNB65 ^{③④}	—	HH65678	HH65678 ^⑦
400 (Series-A)	HNB656AB	—	HH656A	HH656A
600 (Legacy)	HNB66 ^{③④}	—	HH65678	HH65678 ^⑦
600 (Series-A)	HNB656AB	—	HH656A	HH656A
800	HNB67A ^{②⑥}	—	—	HH65678 ^⑦
1200	HNB678 ^②	—	—	HH68 ^⑦

Ampere Rating	Mechanism Assembly Catalog Number	Line & Load Lugs Catalog Number
---------------	-----------------------------------	---------------------------------

Fusible 2- and 3-Pole 60-600A General Duty & 30-1200A Heavy Duty^{⑤⑧}

30 HD 240V	HM6123 ^⑦	HL612 ^①
60 GD	HM6123	HL612 ^①
60 HD 240V	HM6123 ^⑦	HL612 ^①
30 600V	HM6123 ^⑦	HL612 ^①
60 600V	HM6123 ^⑦	HL612 ^①
100	HM6123 ^⑦	HL63 ^①
200	HM64 ^⑦	HL64 ^①
400 (Legacy)	HM65	HL65678 ^⑦
400 (series-A)	HM656A	HL656A ^①
600 (Legacy)	HM66	HL65678 ^⑦
600 (series-A)	HM656A	HL66A ^①
800	HM67A	⑦
1200	HM678	⑦

Non-Fusible 3-Pole 60-600A General Duty & 30-1200A Heavy Duty^{⑤⑧}

30 HD	HM6123 ^⑦	HL612 ^①
60 GD	HM6123	HL612 ^①
60 HD	HM6123 ^⑦	HL612 ^①
100	HM6123 ^⑦	HL63 ^①
200	HM64 ^⑦	HL64 ^①
400 (Legacy)	HM65	HL65678 ^⑦
400 (series-A)	HM656A	HL56A ^①
600 (Legacy)	HM66	HL65678 ^⑦
600 (series-A)	HM656A	HL56A ^①
800	HM67A	⑦
1200	HM678	⑦

Internal Shield Kits

These kits provide an inner door on safety switches to prevent accidental contact with live parts. All kits are constructed from clear plastic, provide test probe holes and allow replacement of fuses without the removal of the kit.

Catalog Number	Switch Ampere Rating	UPC Code 040892_ _ _ _
----------------	----------------------	------------------------

For use with Fusible Type 1, 3R, 12 and 4X Stainless Steel Enclosed Safety Switches^⑧

HSK61SSW	30	79020
HSK62SSW	60	79021
HSK63SSW	100	79002
HSK64SSW	200	79023

For use with Fusible Type VBII Disconnect Switches

HSK61	30	79024
HSK623	60 & 100	79025
HSK64	200	79026

- ① Three lugs included in kit.
- ② Includes lugs.
- ③ Lugs not included.
- ④ One lug per kit.
- ⑤ One per switch required unless otherwise noted.
- ⑥ One required per pole.
- ⑦ For type 4/4X stainless steel switches add "S" to end of catalog number.

- ⑧ For replacement door for heavy duty switches add "DOOR" to end of switch catalog number.
- ⑨ Lugs included with base only, not available separately.
- ⑩ Not for use with Non-metallic safety switches.
- ⑪ Lug caps only—2 line side caps and 2 load side caps per kit.

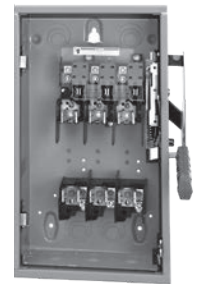

HF362 with HSK62SSW installed



VBFS361F with HSK61 Installed

Load switching devices for all applications

Fuseless switch disconnectors



	Type	3LD3 new	3LD2	3LD5 UL new
	Rated current I_n	16 ... 63 A	16 ... 250 A	30 ... 160 A
	Short-circuit current max.	6 kA	50 kA	50 kA
Selection acc. to utilization category	AC max.	AC-3	AC-3	AC-3
	DC max.	-	DC-22A	-
	Suitable fuses	-	-	-
Types of mounting	Panel mounting	■	■	■
	Mounting on a standard mounting rail	■	■ (up to 125 A)	■ (up to 63 A)
	Front mounting	■	■	■
	Mounting on busbar systems (spacing of the busbars)	-	-	-
	Draw-out technology	-	-	-
Methods of operation	Manual from the front	■	■	■
	Manual from the side	-	-	-
	Remote-controllable	-	-	-
Number of poles	1-pole	-	-	-
	2-pole	-	-	-
	3-pole	■	■	■
	4-pole	■	■	■
	6-pole	-	■	-
Switching function	All poles	■	■	■
	Individual poles switchable	-	-	-

Disconnect Switches

3LD switch disconnectors

Quick select guide



Type			3LD30	3LD31	3LD32	3LD33	3LD34	3LD20	3LD21	3LD22	3LD25	3LD27
General technical specifications acc. to UL												
General technical specifications												
Certification according to UL standard			UL 508					UL 508				
I_n acc. to UL 508/UL60947-4-1 UL489	A		16 –	25 –	32 –	40 –	63 –	16 –	25 –	32 –	63 –	100 –
U_e acc. to UL 508/UL60947-4-1 UL489	V AC		600 –					600 –				
Operating and short-circuit behavior												
Operational power, 3-phase	At 480 V	hp	7.5	10	20	20	25	7.5	10	20	40	60
	At 600 V	hp	10	15	20	20	30	10	15	20	50	75
Short circuit current rating (SCCR)	At 480 V at 600 V	kA	5 5					5 5	5 5	5 5	5 5	10 10
Upstream fuse according to UL			RK5					RK5				

For IEC ratings, reference document in Industry Mall or Global LV10 catalog

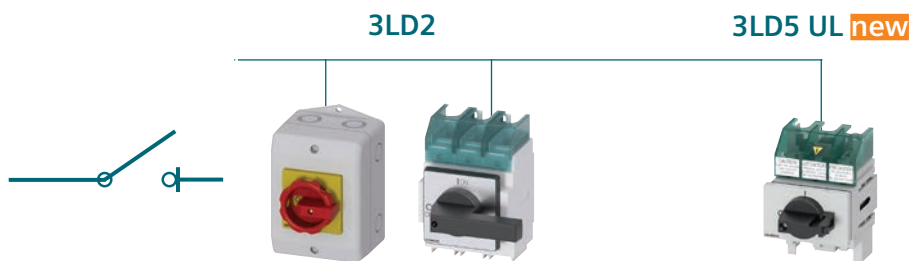

Type			3LD28	3LD23	3LD24	3LD50	3LD52	3LD54	3LD56	3LD58
General technical specifications acc. to UL										
General technical specifications										
Certification according to UL standard			UL 508			UL60947-4-1 / UL489				
I_n acc. to UL 508/UL60947-4-1 UL489	A		125 –	160 –	250 –	30 30	60 60	100 100	125 125	150 150
U_e acc. to UL 508/UL60947-4-1 UL489	V AC		600 –			480 480				
Operating and short-circuit behavior										
Operational power, 3-phase	At 480 V	hp	75	75	100	20	30	60	75	100
	At 600 V	hp	100	50	75	–	–	–	–	–
Short circuit current rating (SCCR)	At 480 V at 600 V	kA	10 10	10 10	10 10	50 –	65 –	65 –	65 –	50 –
Upstream fuse according to UL			RK5			J CC	J	J	J	J

For IEC ratings, reference document in Industry Mall or Global LV10 catalog

Disconnect Switches

3LD switch disconnectors

System overview of 3LD3 main control and EMERGENCY-STOP switches

Basic units for front mounting



3P rotary operating mechanisms



3P knob-operated mechanisms



3P+N rotary operating mechanisms



3P+N knob-operated mechanisms

Basic units for panel mounting



3P rotary operating mechanisms



3P knob-operated mechanisms



3P+N rotary operating mechanisms



3P+N knob-operated mechanisms

Basic units for installation in distribution boards



3P knob-operated mechanisms



3P basic switches without knob-operated mechanism



3P+N knob-operated mechanisms



3P+N basic switches without knob-operated mechanism

Additional poles and auxiliary switches



N switching contacts



N/PE terminals



Auxiliary switches

Operating mechanisms



Rotary operating mechanisms for front or panel mounting (center hole)



Knob-operated mechanisms for front or panel mounting (center hole)



Door-coupling rotary operating mechanisms



Door-coupling knob-operated mechanisms

Other accessories



Terminal covers, 1 and 3-pole

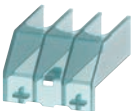

Inscription labels



Note: You will find a detailed range of accessories with the basic units.

Disconnect Switches

3LD switch disconnectors

3LD3 mounting and accessories

Mounting concept and accessories

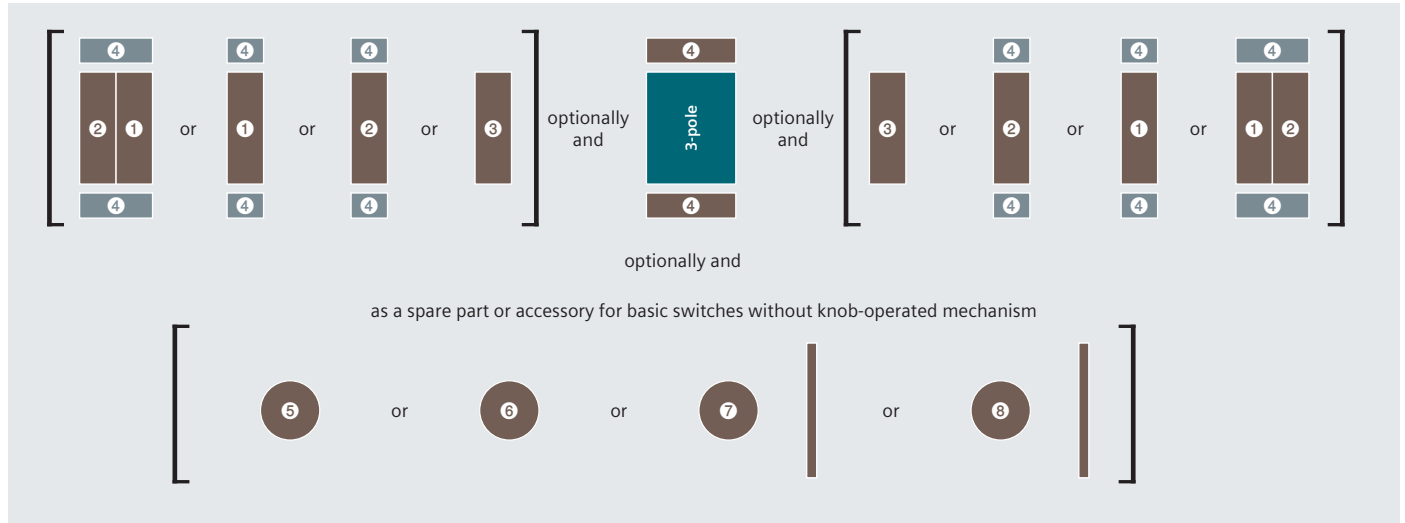

Legend

- 1) N switching contact ¹⁾
- 2) N/PE terminal
- 3) Auxiliary switch
- 4) Terminal cover
- 5) Rotary operating mechanism, center-hole mounting
- 6) Knob-operated mechanism, center-hole mounting
- 7) Door-coupling rotary operating mechanism, center-hole mounting
- 8) Door-coupling knob-operated mechanism, center-hole mounting

¹⁾ The N switching contact 1 first has to be mounted on the basic unit



Mounting types

Front mounting



The switches for front mounting are mounted on the inside of covers, side panels or, if applicable, control cabinet doors (depending on the applicable standard and switching function). The switches are mounted via the 22.5 mm diameter center hole.

You will find further information in the configuration manual: sie.ag/2UIrAvy



Panel mounting



The switches for panel mounting are snapped onto 35 mm standard mounting rails according to EN 60715 or screw-mounted on mounting panels. The actuators are connected to the lower section of the switch through a door coupling, which can be released in its zero position, and a 300 mm long switch shaft. When the control cabinet door is open, the switch can be protected against inadvertent operation by removing the switch shaft from the lower section of the switch. The overall depth can be adapted to individual requirements by adjusting the switch shaft length.

Distribution board mounting



The switches for distribution board mounting are suited for operation in distribution boards and for switching inside control cabinets or distributors. They have cap and mounting dimensions acc. to DIN 43880 and can be fitted under the same cover together with miniature circuit breakers. The selector switches can be locked in their OFF position with no more than one padlock with a hasp thickness of 4 to 6 mm.

Basic switches without knob-operated mechanism



For the basic switch variant without knob-operated mechanism, the appropriate door-coupling rotary operating mechanism can be ordered separately.

Disconnect Switches

3LD switch disconnectors

3LD3 main control and EMERGENCY-STOP switches, front mounting, 6 kA_{rms}

3LD3 main control and EMERGENCY-STOP switches, front mounting



Operating mechanisms, black

Number of poles 3P

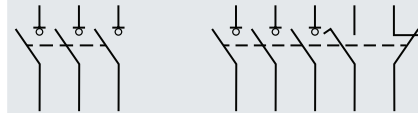

Uninterrupted current I _u At AC-21A, 380 ... 440 V	Operational power P At AC-23A, 380 ... 440 V	Operational power P At AC-3, 380 ... 440 V	Without auxiliary switch	1 NO + 1 NC
Rotary operating mechanisms				
16 A	7.5 kW	5.5 kW	3LD3054-0TK51	3LD3054-1TK51
25 A	9 kW	7.5 kW	3LD3154-0TK51	3LD3154-1TK51
32 A	11.5 kW	9.5 kW	3LD3254-0TK51	3LD3254-1TK51
40 A	18.5 kW	11.5 kW	3LD3354-0TK51	3LD3354-1TK51
63 A	22 kW	18.5 kW	3LD3454-0TK51	3LD3454-1TK51
Knob-operated mechanisms				
16 A	7.5 kW	5.5 kW	3LD3050-0TK11	3LD3050-1TK11
25 A	9 kW	7.5 kW	3LD3150-0TK11	3LD3150-1TK11
32 A	11.5 kW	9.5 kW	3LD3250-0TK11	3LD3250-1TK11
40 A	18.5 kW	11.5 kW	3LD3350-0TK11	3LD3350-1TK11
63 A	22 kW	18.5 kW	3LD3450-0TK11	3LD3450-1TK11

Scope of supply:

- Including terminal covers for the infeed side

Accessories

			3LD30 (16 A)	3LD31 (25 A)	3LD32 (32 A)	3LD33 (40 A)	3LD34 (63 A)	
Additional poles								
	Variant	Contacts	Catalog No.					
	Switching contact for N conductor (4th contact)	Leading switch-on, lagging switch-off	3LD9340-0B	■	■	■	■	■
	N terminal	Through-type	3LD9340-2B	■	■	■	■	■
	PE terminal	Through-type	3LD9340-3B	■	■	■	■	■
Auxiliary switches								
		Contacts	Catalog No.					
		1 NO + 1 NC	3LD9340-6B	■	■	■	■	■
Rotary operating mechanisms								
		Color	Catalog No.					
		Black	3LD9344-4C	■	■	■	■	■
		Red/yellow	3LD9344-5C	■	■	■	■	■
Knob-operated mechanisms								
		Color	Catalog No.					
		Black	3LD9343-6C	■	■	■	■	■
		Red/yellow	3LD9343-7C	■	■	■	■	■

Disconnect Switches

3LD switch disconnectors

3LD3 main control and EMERGENCY-STOP switches, front mounting, 6 kA_{rms}

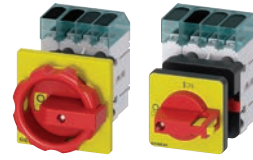
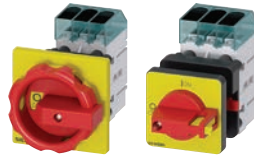
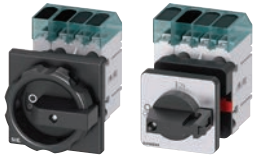

Operating mechanisms, red/yellow

3P+N

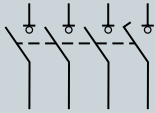

Without auxiliary switch

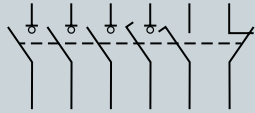

1 NO + 1 NC

3P

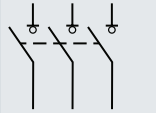

Without auxiliary switch

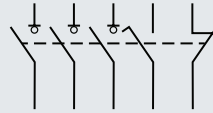

1 NO + 1 NC

3P+N

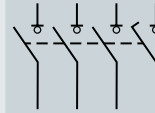

Without auxiliary switch

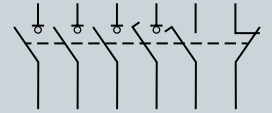

1 NO + 1 NC

3LD3054-0TL51	3LD3054-1TL51	3LD3054-0TK53	3LD3054-1TK53	3LD3054-0TL53	3LD3054-1TL53
3LD3154-0TL51	3LD3154-1TL51	3LD3154-0TK53	3LD3154-1TK53	3LD3154-0TL53	3LD3154-1TL53
3LD3254-0TL51	3LD3254-1TL51	3LD3254-0TK53	3LD3254-1TK53	3LD3254-0TL53	3LD3254-1TL53
3LD3354-0TL51	3LD3354-1TL51	3LD3354-0TK53	3LD3354-1TK53	3LD3354-0TL53	3LD3354-1TL53
3LD3454-0TL51	3LD3454-1TL51	3LD3454-0TK53	3LD3454-1TK53	3LD3454-0TL53	3LD3454-1TL53
3LD3050-0TL11	3LD3050-1TL11	3LD3050-0TK13	3LD3050-1TK13	3LD3050-0TL13	3LD3050-1TL13
3LD3150-0TL11	3LD3150-1TL11	3LD3150-0TK13	3LD3150-1TK13	3LD3150-0TL13	3LD3150-1TL13
3LD3250-0TL11	3LD3250-1TL11	3LD3250-0TK13	3LD3250-1TK13	3LD3250-0TL13	3LD3250-1TL13
3LD3350-0TL11	3LD3350-1TL11	3LD3350-0TK13	3LD3350-1TK13	3LD3350-0TL13	3LD3350-1TL13
3LD3450-0TL11	3LD3450-1TL11	3LD3450-0TK13	3LD3450-1TK13	3LD3450-0TL13	3LD3450-1TL13

	3LD30 (16 A)	3LD31 (25 A)	3LD32 (32 A)	3LD33 (40 A)	3LD34 (63 A)
--	-----------------	-----------------	-----------------	-----------------	-----------------

Terminal covers

- Pack of 4 units

Version

For N switching contacts, N terminals or PE terminals

Catalog No.

3LD9341-2A



For 3-pole 3LD3 switch disconnectors

3LD9341-0A

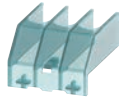

Inscription labels

- Pack of 10 units

Inscription

German / English (Hauptschalter / Main Switch)

French / Spanish (Interrupteur Principal / Interruptor Principal)

Without inscription

Catalog No.

3LD9346-1A

3LD9346-2A

3LD9346-3A



18

SWITCHES

Disconnect Switches

3LD switch disconnectors

3LD3 main control and EMERGENCY-STOP switches, panel mounting, 6 kA_{rms}

3LD3 main control and EMERGENCY-STOP switches, panel mounting



Operating mechanisms, black

Number of poles 3P

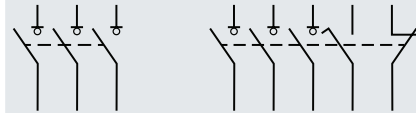

Uninterrupted current I _u At AC-21A, 380 ... 440 V	Operational power P At AC-23A, 380 ... 440 V	Operational power P At AC-3, 380 ... 440 V	Without auxiliary switch	1 NO + 1 NC
Rotary operating mechanisms				
16 A	7.5 kW	5.5 kW	3LD3048-0TK51	3LD3048-1TK51
25 A	9 kW	7.5 kW	3LD3148-0TK51	3LD3148-1TK51
32 A	11.5 kW	9.5 kW	3LD3248-0TK51	3LD3248-1TK51
40 A	18.5 kW	11.5 kW	3LD3348-0TK51	3LD3348-1TK51
63 A	22 kW	18.5 kW	3LD3448-0TK51	3LD3448-1TK51
Knob-operated mechanisms				
16 A	7.5 kW	5.5 kW	3LD3040-0TK11	3LD3040-1TK11
25 A	9 kW	7.5 kW	3LD3140-0TK11	3LD3140-1TK11
32 A	11.5 kW	9.5 kW	3LD3240-0TK11	3LD3240-1TK11
40 A	18.5 kW	11.5 kW	3LD3340-0TK11	3LD3340-1TK11
63 A	22 kW	18.5 kW	3LD3440-0TK11	3LD3440-1TK11

Scope of supply:

- Including terminal covers for the infeed side

Mounting:

- Using screws or snap-on mounting on 35 mm mounting rails

Accessories

			3LD30 (16 A)	3LD31 (25 A)	3LD32 (32 A)	3LD33 (40 A)	3LD34 (63 A)	
Additional poles								
	Variant	Contacts	Catalog No.					
	Switching contact for N conductor (4th contact)	Leading switch-on, lagging switch-off	3LD9340-0C	■	■	■	■	■
	N terminal	Through-type	3LD9340-2C	■	■	■	■	■
	PE terminal	Through-type	3LD9340-3C	■	■	■	■	■
Auxiliary switches								
		Contacts	Catalog No.					
		1 NO + 1 NC	3LD9340-6C	■	■	■	■	■
Rotary operating mechanisms								
	Version	Color	Catalog No.					
	Incl. funnel	Black	3LD9344-2C	■	■	■	■	■
		Red/yellow	3LD9344-3C	■	■	■	■	■
Knob-operated mechanisms								
	Version	Color	Catalog No.					
	Incl. funnel	Black	3LD9343-4C	■	■	■	■	■
		Red/yellow	3LD9343-5C	■	■	■	■	■

Disconnect Switches



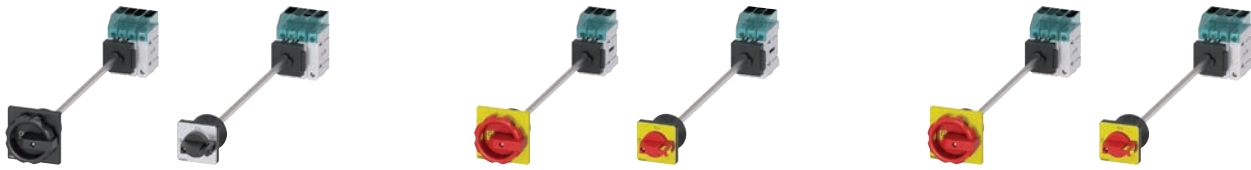

3LD switch disconnectors

3LD3 main control and EMERGENCY-STOP switches, panel mounting, 6 kA_{rms}

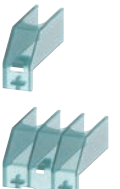

Operating mechanisms, red/yellow

3P+N		3P		3P+N	
Without auxiliary switch	1 NO + 1 NC	Without auxiliary switch	1 NO + 1 NC	Without auxiliary switch	1 NO + 1 NC
3LD3048-0TL51	3LD3048-1TL51	3LD3048-0TK53	3LD3048-1TK53	3LD3048-0TL53	3LD3048-1TL53
3LD3148-0TL51	3LD3148-1TL51	3LD3148-0TK53	3LD3148-1TK53	3LD3148-0TL53	3LD3148-1TL53
3LD3248-0TL51	3LD3248-1TL51	3LD3248-0TK53	3LD3248-1TK53	3LD3248-0TL53	3LD3248-1TL53
3LD3348-0TL51	3LD3348-1TL51	3LD3348-0TK53	3LD3348-1TK53	3LD3348-0TL53	3LD3348-1TL53
3LD3448-0TL51	3LD3448-1TL51	3LD3448-0TK53	3LD3448-1TK53	3LD3448-0TL53	3LD3448-1TL53
3LD3040-0TL11	3LD3040-1TL11	3LD3040-0TK13	3LD3040-1TK13	3LD3040-0TL13	3LD3040-1TL13
3LD3140-0TL11	3LD3140-1TL11	3LD3140-0TK13	3LD3140-1TK13	3LD3140-0TL13	3LD3140-1TL13
3LD3240-0TL11	3LD3240-1TL11	3LD3240-0TK13	3LD3240-1TK13	3LD3240-0TL13	3LD3240-1TL13
3LD3340-0TL11	3LD3340-1TL11	3LD3340-0TK13	3LD3340-1TK13	3LD3340-0TL13	3LD3340-1TL13
3LD3440-0TL11	3LD3440-1TL11	3LD3440-0TK13	3LD3440-1TK13	3LD3440-0TL13	3LD3440-1TL13

			3LD30 (16 A)	3LD31 (25 A)	3LD32 (32 A)	3LD33 (40 A)	3LD34 (63 A)
Switching shafts							
	Cross-section 6 × 6 mm	Length 600 mm	Catalog No. 3LD93451C	■	■	■	■
Door-coupling rotary operating mechanisms							
	Variant Rotary operating mechanisms 66 × 66 mm	Color Black Red/yellow	Catalog No. 3LD9344-2CA 3LD9344-3CA	■	■	■	■
	Variant Knob-operated mechanisms 48 × 48 mm	Color Black Red/yellow	Catalog No. 3LD9343-4CA 3LD9343-5CA	■	■	■	■
Terminal covers							
	• Pack of 4 units	Version For N switching contacts, N terminals or PE terminals	Catalog No. 3LD9341-2A	■	■	■	■
		For 3LD3 3-pole switch disconnectors	3LD9341-0A	■	■	■	■
Inscription labels							
	• Pack of 10 units	Inscription German / English (Hauptschalter / Main Switch) French / Spanish (Interrupteur Principal / Interruptor Principal) Without inscription	Catalog No. 3LD9346-1A 3LD9346-2A 3LD9346-3A	■	■	■	■

Disconnect Switches

3LD switch disconnectors

3LD3 main control and EMERGENCY-STOP switches, distribution boards and without direct operating mechanism, 6 kA_{rms}

3LD3 main control and EMERGENCY-STOP switches, installation in distribution boards and basic switches without direct operating mechanism



Operating mechanisms, black

Number of poles 3P

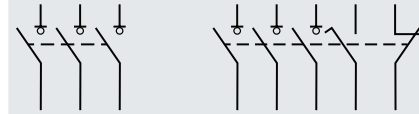

Uninterrupted current I _U At AC-21A, 380 ... 440 V	Operational power P At AC-23A, 380 ... 440 V	Operational power P At AC-3, 380 ... 440 V	Without auxiliary switch	1 NO + 1 NC
Basic switch with masking plate and selector knob, standard rail mounting				
16 A	7.5 kW	5.5 kW	3LD3030-0TK11	3LD3030-1TK11
25 A	9 kW	7.5 kW	3LD3130-0TK11	3LD3130-1TK11
32 A	11.5 kW	9.5 kW	3LD3230-0TK11	3LD3230-1TK11
40 A	18.5 kW	11.5 kW	3LD3330-0TK11	3LD3330-1TK11
63 A	22 kW	18.5 kW	3LD3430-0TK11	3LD3430-1TK11
Basic switches without knob-operated mechanism				
16 A	7.5 kW	5.5 kW	3LD3010-0TK05	3LD3010-1TK05
25 A	9 kW	7.5 kW	3LD3110-0TK05	3LD3110-1TK05
32 A	11.5 kW	9.5 kW	3LD3210-0TK05	3LD3210-1TK05
40 A	18.5 kW	11.5 kW	3LD3310-0TK05	3LD3310-1TK05
63 A	22 kW	18.5 kW	3LD3410-0TK05	3LD3410-1TK05

Scope of supply:

- Basic switches without direct operating mechanism, incl. terminal covers for the infeed side

Mounting:

- Using screws or snap-on mounting on 35 mm mounting rails

Accessories for switches for installation in distribution boards and basic switches without knob-operated mechanism

		3LD30 (16 A)	3LD31 (25 A)	3LD32 (32 A)	3LD33 (40 A)	3LD34 (63 A)		
Additional poles								
	Variant	Contacts					Catalog No.	
	Switching contact for N conductor (4th contact)	Leading switch-on, lagging switch-off	3LD9340-0C	■	■	■	■	■
	N terminal	Through-type	3LD9340-2C	■	■	■	■	■
	PE terminal	Through-type	3LD9340-3C	■	■	■	■	■
Auxiliary switches								
		Contacts					Catalog No.	
		1 NO + 1 NC	3LD9340-6C	■	■	■	■	■
Terminal covers								
		• Pack of 4 units						
	Version	Catalog No.						
	For N switching contacts, N terminals or PE terminals	3LD9341-2A	■	■	■	■	■	
	For 3LD3 3-pole switch disconnectors	3LD9341-0A	■	■	■	■	■	
Switching shafts								
	Cross-section	Length	Catalog No.					
	6 × 6 mm	600 mm	3LD93451C	■	■	■	■	■

Disconnect Switches

3LD switch disconnectors

3LD3 main control and EMERGENCY-STOP switches, distribution boards and without direct operating mechanism, 6 kA_{rms}



Operating mechanisms, red/yellow

3P+N

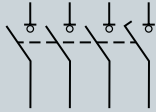

Without auxiliary switch

1 NO + 1 NC

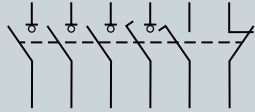

3P

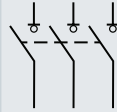

Without auxiliary switch

1 NO + 1 NC

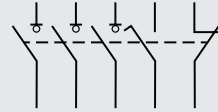

3P+N

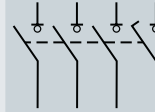

Without auxiliary switch

1 NO + 1 NC

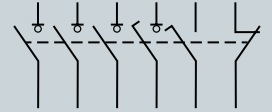

3LD3030-OTL11

3LD3030-1TL11

3LD3030-OTK13

3LD3030-1TK13

3LD3030-OTL13

3LD3030-1TL13

3LD3130-OTL11

3LD3130-1TL11

3LD3130-OTK13

3LD3130-1TK13

3LD3130-OTL13

3LD3130-1TL13

3LD3230-OTL11

3LD3230-1TL11

3LD3230-OTK13

3LD3230-1TK13

3LD3230-OTL13

3LD3230-1TL13

3LD3330-OTL11

3LD3330-1TL11

3LD3330-OTK13

3LD3330-1TK13

3LD3330-OTL13

3LD3330-1TL13

3LD3430-OTL11

3LD3430-1TL11

3LD3430-OTK13

3LD3430-1TK13

3LD3430-OTL13

3LD3430-1TL13

3LD3010-OTL05

3LD3010-1TL05

–

–

–

–

3LD3110-OTL05

3LD3110-1TL05

–

–

–

–

3LD3210-OTL05

3LD3210-1TL05

–

–

–

–

3LD3310-OTL05

3LD3310-1TL05

–

–

–

–

3LD3410-OTL05

3LD3410-1TL05

–

–

–

–

Accessories for basic switches without operating mechanism

3LD30
(16 A)

3LD31
(25 A)

3LD32
(32 A)

3LD33
(40 A)

3LD34
(63 A)

Rotary operating mechanisms



Version

Incl. funnel

Color

Black

Red/yellow

Catalog No.

3LD9344-2C

3LD9344-3C

Knob-operated mechanisms



Version

Incl. funnel

Color

Black

Red/yellow

Catalog No.

3LD9343-4C

3LD9343-5C

Door-coupling rotary operating mechanisms



Variant

Rotary operating mechanisms 66 × 66 mm

Color

Black

Red/yellow

Catalog No.

3LD9344-2CA

3LD9344-3CA



Knob-operated mechanisms 48 × 48 mm

Color

Black

Red/yellow

Catalog No.

3LD9343-4CA

3LD9343-5CA

Switching shafts



Cross-section

6 × 6 mm

Length

600 mm

Catalog No.

3LD93451C

Inscription labels



• Pack of 10 units

Inscription

German / English (Hauptschalter / Main Switch)

French / Spanish (Interrupteur Principal / Interruptor Principal)

Without inscription

Catalog No.

3LD9346-1A

3LD9346-2A

3LD9346-3A

18









SWITCHES

Disconnect Switches

3LD switch disconnectors

3LD3 main control and EMERGENCY-STOP switches, accessories

3LD3 main control and EMERGENCY-STOP switches, accessories

				3LD30 (16 A)	3LD31 (25 A)	3LD32 (32 A)	3LD33 (40 A)	3LD34 (63 A)
Switching contacts for N conductor (4th contact)								
	Version	Contacts	Catalog No.					
	For front mounting	Leading switch-on, lagging switch-off	3LD9340-0B	■	■	■	■	■
	Version	Contacts	Catalog No.					
	For panel mounting, installation in distribution boards and basic switches without knob-operated mechanism	Leading switch-on, lagging switch-off	3LD9340-0C	■	■	■	■	■
N terminals								
	Version	Contacts	Catalog No.					
	For front mounting	Through-type	3LD9340-2B	■	■	■	■	■
	Version	Contacts	Catalog No.					
	For panel mounting, installation in distribution boards and basic switches without knob-operated mechanism	Through-type	3LD9340-2C	■	■	■	■	■
PE terminals								
	Version	Contacts	Catalog No.					
	For front mounting	Through-type	3LD9340-3B	■	■	■	■	■
	Version	Contacts	Catalog No.					
	For panel mounting, installation in distribution boards and basic switches without knob-operated mechanism	Through-type	3LD9340-3C	■	■	■	■	■
Auxiliary switches								
	Version	Contacts	Catalog No.					
	For front mounting	1 NO + 1 NC	3LD9340-6B	■	■	■	■	■
	Version	Contacts	Catalog No.					
	For panel mounting, installation in distribution boards and basic switches without knob-operated mechanism	1 NO + 1 NC	3LD9340-6C	■	■	■	■	■

Disconnect Switches

3LD switch disconnectors

3LD3 main control and EMERGENCY-STOP switches, accessories

3LD3 main control and EMERGENCY-STOP switches, accessories

				3LD30 (16 A)	3LD31 (25 A)	3LD32 (32 A)	3LD33 (40 A)	3LD34 (63 A)
Rotary operating mechanisms								
		Version	Color	Catalog No.				
		For front mounting, without funnel	Black	3LD9344-4C	■	■	■	■
			Red/ yellow	3LD9344-5C	■	■	■	■
		For panel mounting and basic switches without knob-operated mechanism, with funnel	Black	3LD9344-2C	■	■	■	■
			Red/ yellow	3LD9344-3C	■	■	■	■
Knob-operated mechanisms								
		Version	Color	Catalog No.				
		For front mounting, without funnel	Black	3LD9343-6C	■	■	■	■
			Red/ yellow	3LD9343-7C	■	■	■	■
		For panel mounting and basic switches without knob-operated mechanism, with funnel	Black	3LD9343-4C	■	■	■	■
			Red/ yellow	3LD9343-5C	■	■	■	■
Door-coupling rotary operating mechanisms								
		Version	Variant	Color	Catalog No.			
		For panel mounting and basic switches without knob-operated mechanism	Rotary operating mechanisms 66 × 66 mm	Black	3LD9344-2CA	■	■	■
				Red/ yellow	3LD9344-3CA	■	■	■
			Knob-operated mechanisms 48 × 48 mm	Black	3LD9343-4CA	■	■	■
				Red/ yellow	3LD9343-5CA	■	■	■
Terminal covers								
		<ul style="list-style-type: none"> For front mounting, panel mounting, installation in distribution boards and basic switches without knob-operated mechanism Pack of 4 units 						
		Number of poles	Catalog No.					
		1-pole	3LD9341-2A	■	■	■	■	
		3-pole	3LD9341-0A	■	■	■	■	
Switching shafts								
		Cross-section	Length	Catalog No.				
		6 × 6 mm	600 mm	3LD93451C	■	■	■	
Inscription labels								
		<ul style="list-style-type: none"> Pack of 10 units Not for installation in distribution boards 						
		Inscription	Catalog No.					
		German / English (Hauptschalter / Main Switch)	3LD9346-1A	■	■	■	■	
		French / Spanish (Interrupteur Principal / Interruptor Principal)	3LD9346-2A	■	■	■	■	
		Without inscription	3LD9346-3A	■	■	■	■	

Disconnect Switches

3LD switch disconnectors

System overview of 3LD2 switch disconnectors

Basic units for front mounting



3P rotary operating mechanisms



3P knob-operated mechanisms (3LD23/3LD24)



3P knob-operated mechanisms



3P+N rotary operating mechanisms



3P+N knob-operated mechanisms (3LD23/3LD24)



3P+N knob-operated mechanisms



6P rotary operating mechanisms

Basic units for panel mounting



3P rotary operating mechanisms



3P knob-operated mechanisms (3LD23/3LD24)



3P knob-operated mechanisms, defeatable



3P+N rotary operating mechanisms



3P+N knob-operated mechanisms (3LD23/3LD24)



3P+N knob-operated mechanisms, defeatable



6P rotary operating mechanisms

Basic units for installation in distribution boards/enclosures, DC



3P knob-operated mechanisms



3P+N knob-operated mechanisms



8P DC isolators

Additional poles and auxiliary switches



N switching contacts



N/PE terminals (through-type)



Auxiliary switches (standard version)



Auxiliary switch for mounting on the front **new**

Operating mechanisms



Rotary operating mechanisms for 4-hole and center-hole mounting



Knob-operated mechanisms (3LD23/3LD24)



Switching shafts



Coupling pieces without ON-lock



Assembly tools for center-hole mounting

Other accessories



Terminal covers, 1-pole



Terminal covers, 3 and 4-pole



Inscription labels (with and without inscription)

Note:

You will find a detailed range of accessories with the basic units.

Mounting concept and accessories

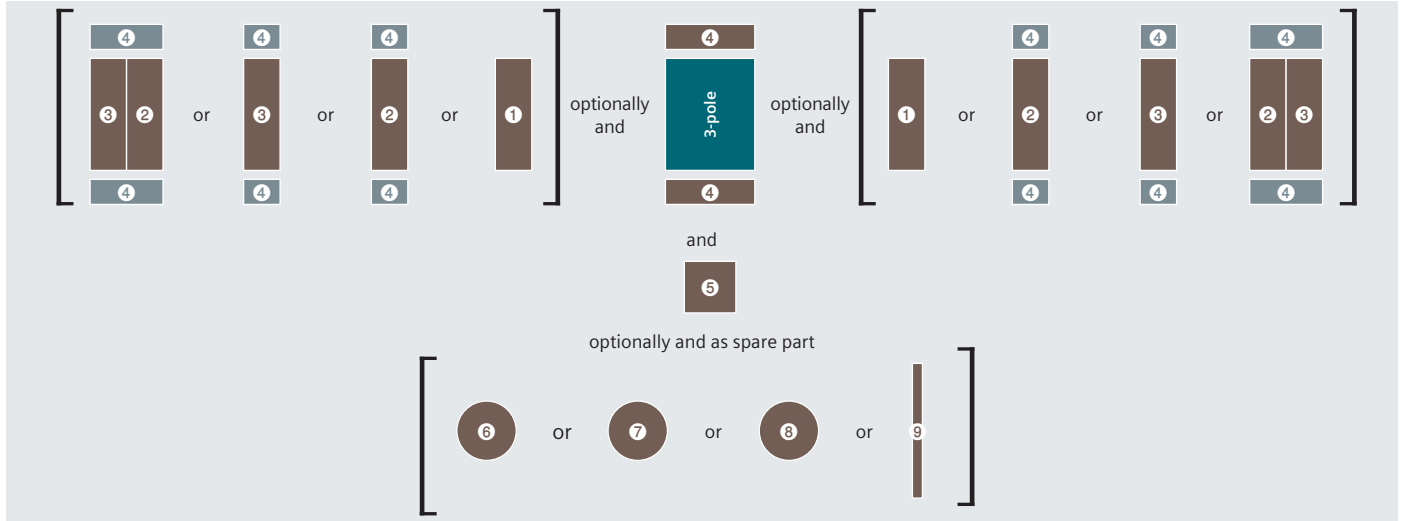

Legend

- ❶ Auxiliary switch
- ❷ N switching contact ¹⁾
- ❸ N/PE terminal
- ❹ Terminal cover
- ❺ Auxiliary switch for mounting on the front ²⁾
- ❻ Rotary operating mechanism, center-hole mounting
- ❼ Rotary operating mechanism, four-hole mounting
- ❽ Knob-operated mechanism, four-hole mounting
- ❾ Switching shaft (300 or 600)

¹⁾ The N switching contact ❷ first has to be mounted on the basic unit
²⁾ Can only be used with four-hole front mounting and panel mounting



Mounting types

You will find further information in the configuration manual: sie.ag/2UlrAvy



Front mounting



The switches for front mounting are mounted on the inside of covers, side panels or, if applicable, control cabinet doors (depending on the applicable standard and switching function). In addition to the 4-hole fastening of the handle, up to 63 A (3LD25) fastening with the 22.5 mm diameter center hole can also be chosen.

Panel mounting



The switches for panel mounting up to 125 A (3LD28) are snapped onto 35 mm standard mounting rails according to EN 60715 or screw-mounted on mounting panels. The switches for 160 and 250 A (3LD23/3LD24) are exclusively screwed onto mounting panels. The actuators are connected to the lower section of the switch through a door coupling, which can be released in its zero position, and a 300 mm long switch shaft. When the control cabinet door is open, the switch can be protected against inadvertent operation by removing the switch shaft from the lower section of the switch. The overall depth can be adapted to individual requirements by adjusting the switch shaft length.

Distribution board mounting



The switches for distribution board mounting are suited for operation in distribution boards and for switching inside control cabinets or distributors. Up to 125 A (3LD28), they have cap and mounting dimensions acc. to DIN 43880 and can be fitted under the same cover together with miniature circuit breakers.

DC isolators



The DC isolators in the enclosure are suitable for disconnecting loads of up to 800 V DC due to their 8-pole design. To provide additional safety, the isolators can be locked in the 0 position.

Disconnect Switches

3LD switch disconnectors

3LD2 main control switches, front mounting, 25 ... 50 kA_{eff}

3LD2 main control switches, front mounting



Operating mechanisms, black

Number of poles 3P

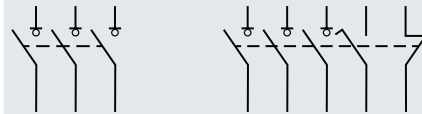

Uninterrupted current I _u At AC-21A, 380 ... 440 V	Operational power P At AC-23A, 380 ... 440 V	Operational power P At AC-3A, 380 ... 440 V	Without auxiliary switch	1 NO + 1 NC (standard version)
Rotary operating mechanism, four-hole mounting				
16 A	7.5 kW	5.5 kW	3LD2003-0TK51	3LD2003-1TP51
25 A	9.5 kW	7.5 kW	3LD2103-0TK51	3LD2103-1TP51
32 A	11.5 kW	9.5 kW	3LD2203-0TK51	3LD2203-1TP51
63 A	22 kW	18.5 kW	3LD2504-0TK51	3LD2504-1TP51
100 A	37 kW	30 kW	3LD2704-0TK51	3LD2704-1TP51
125 A	45 kW	37 kW	3LD2804-0TK51	3LD2804-1TP51
160 A	75 kW	50 kW	3LD2305-0TK11	3LD2305-0TK11 + 3LD9200-5B
250 A	132 kW	110 kW	3LD2405-0TK11	3LD2405-0TK11 + 3LD9200-5B
Rotary operating mechanism, center-hole mounting Ø 22.5 mm				
16 A	7.5 kW	5.5 kW	3LD2054-0TK51	3LD2054-1TP51
25 A	9.5 kW	7.5 kW	3LD2154-0TK51	3LD2154-1TP51
32 A	11.5 kW	9.5 kW	3LD2254-0TK51	3LD2254-0TK51 + 3LD9200-5B
63 A	22 kW	18.5 kW	3LD2555-0TK51	3LD2555-0TK51 + 3LD9200-5B
Knob-operated mechanism, four-hole mounting				
16 A	7.5 kW	5.5 kW	3LD2022-0TK11	3LD2022-0TK11 + 3LD9200-5B
25 A	9.5 kW	7.5 kW	3LD2122-0TK11	3LD2122-0TK11 + 3LD9200-5B
32 A	11.5 kW	9.5 kW	3LD2222-0TK11	3LD2222-0TK11 + 3LD9200-5B
Knob-operated mechanism, center-hole mounting Ø 22.5 mm				
16 A	7.5 kW	5.5 kW	3LD2050-0TK11	3LD2050-0TK11 + 3LD9200-5B
25 A	9.5 kW	7.5 kW	3LD2150-0TK11	3LD2150-0TK11 + 3LD9200-5B
32 A	11.5 kW	9.5 kW	3LD2250-0TK11	3LD2250-0TK11 + 3LD9200-5B

Scope of supply:

- Including terminal covers for the infeed side

Accessories, see pages 18/54 to 18/55

Disconnect Switches

3LD switch disconnectors

3LD2 main control switches, front mounting, 25 ... 50 kA_{eff}



3P+N

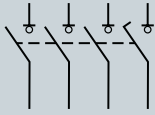

Without auxiliary switch

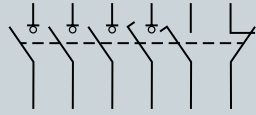

1 NO + 1 NC (standard version)

6P

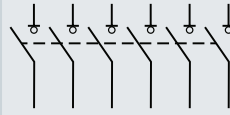

Without auxiliary switch

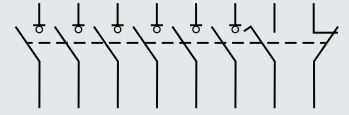

1 NO + 1 NC (standard version)

3LD2003-1TL51	3LD2003-2EP51	-	-
3LD2103-1TL51	3LD2103-2EP51	3LD2103-3VK51	3LD2103-4VP51
3LD2203-1TL51	3LD2203-1TL51 + 3LD9200-5B	3LD2203-3VK51	3LD2203-3VK51 + 3LD9200-5B
3LD2504-1TL51	3LD2504-1TP51 + 3LD9250-0BA	3LD2504-3VK51	3LD2504-3VK51 + 3LD9200-5B
3LD2704-0TK51 + 3LD9280-0B	3LD2704-0TK51 + 3LD9280-0B + 3LD9200-5B	-	-
3LD2804-0TK51 + 3LD9280-0B	3LD2804-0TK51 + 3LD9280-0B + 3LD9200-5B	-	-
3LD2305-1TL11	3LD2305-1TL11 + 3LD9200-5B	3LD2305-3VK11	3LD2305-3VK11 + 3LD9200-5B
3LD2405-1TL11	3LD2405-1TL11 + 3LD9200-5B	3LD2405-3VK11	3LD2405-3VK11 + 3LD9200-5B
3LD2054-1TL51	3LD2054-2EP51	-	-
3LD2154-1TL51	3LD2154-2EP51	-	-
3LD2254-1TL51	3LD2254-1TL51 + 3LD9200-5B	-	-
3LD2555-0TK51 + 3LD9250-0BA	3LD2555-0TK51 + 3LD9250-0BA + 3LD9200-5B	-	-
3LD2022-1TL11	3LD2022-1TL11 + 3LD9200-5B	-	-
3LD2122-1TL11	3LD2122-1TL11 + 3LD9200-5B	-	-
3LD2222-0TK11 + 3LD9220-0B	3LD2222-0TK11 + 3LD9220-0B + 3LD9200-5B	-	-
3LD2050-1TL11	3LD2050-1TL11 + 3LD9200-5B	-	-
3LD2150-0TK11 + 3LD9220-0B	3LD2150-0TK11 + 3LD9220-0B + 3LD9200-5B	-	-
3LD2250-0TK11 + 3LD9220-0B	3LD2250-0TK11 + 3LD9220-0B + 3LD9200-5B	-	-

Disconnect Switches

3LD switch disconnectors

3LD2 EMERGENCY-STOP switches, front mounting, 25 ... 50 kA_{eff}

3LD2 EMERGENCY-STOP switches, front mounting



Operating mechanisms, red/yellow

Number of poles 3P

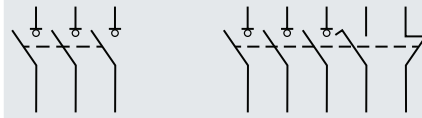

Uninterrupted current I _u At AC-21A, 380 ... 440 V	Operational power P At AC-23A, 380 ... 440 V	Operational power P At AC-3A, 380 ... 440 V	Without auxiliary switch	1 NO + 1 NC (standard version)
Rotary operating mechanism, four-hole mounting				
16 A	7.5 kW	5.5 kW	3LD2003-0TK53	3LD2003-1TP53
25 A	9.5 kW	7.5 kW	3LD2103-0TK53	3LD2103-1TP53
32 A	11.5 kW	9.5 kW	3LD2203-0TK53	3LD2203-1TP53
63 A	22 kW	18.5 kW	3LD2504-0TK53	3LD2504-1TP53
100 A	37 kW	30 kW	3LD2704-0TK53	3LD2704-1TP53
125 A	45 kW	37 kW	3LD2804-0TK53	3LD2804-1TP53
160 A	75 kW	50 kW	3LD2305-0TK13	3LD2305-0TK13 + 3LD9200-5B
250 A	132 kW	110 kW	3LD2405-0TK13	3LD2405-0TK13 + 3LD9200-5B
Rotary operating mechanism, center-hole mounting Ø 22.5 mm				
16 A	7.5 kW	5.5 kW	3LD2054-0TK53	3LD2054-1TP53
25 A	9.5 kW	7.5 kW	3LD2154-0TK53	3LD2154-1TP53
32 A	11.5 kW	9.5 kW	3LD2254-0TK53	3LD2254-0TK53 + 3LD9200-5B
63 A	22 kW	18.5 kW	3LD2555-0TK53	3LD2555-0TK53 + 3LD9200-5B
Knob-operated mechanism, four-hole mounting				
16 A	7.5 kW	5.5 kW	3LD2022-0TK13	3LD2022-0TK13 + 3LD9200-5B
25 A	9.5 kW	7.5 kW	3LD2122-0TK13	3LD2122-0TK13 + 3LD9200-5B
32 A	11.5 kW	9.5 kW	3LD2222-0TK13	3LD2222-0TK13 + 3LD9200-5B
Knob-operated mechanism, center-hole mounting Ø 22.5 mm				
16 A	7.5 kW	5.5 kW	3LD2050-0TK13	3LD2050-0TK13 + 3LD9200-5B
25 A	9.5 kW	7.5 kW	3LD2150-0TK13	3LD2150-0TK13 + 3LD9200-5B
32 A	11.5 kW	9.5 kW	3LD2250-0TK13	3LD2250-0TK13 + 3LD9200-5B

Scope of supply:

- Including terminal covers for the infeed side

Accessories, see pages 18/54 to 18/55

Disconnect Switches

3LD switch disconnectors

3LD2 EMERGENCY-STOP switches, front mounting, 25 ... 50 kA_{eff}







3+N		6P	
Without auxiliary switch	1 NO + 1 NC (standard version)	Without auxiliary switch	1 NO + 1 NC (standard version)
3LD2003-1TL53	3LD2003-2EP53	-	-
3LD2103-1TL53	3LD2103-2EP53	3LD2103-3VK53	3LD2103-4VP53
3LD2203-1TL53	3LD2203-1TL53 + 3LD9200-5B	3LD2203-3VK53	3LD2203-3VK53 + 3LD9200-5B
3LD2504-1TL53	3LD2504-1TP53 + 3LD9250-0BA	3LD2504-3VK53	3LD2504-3VK53 + 3LD9200-5B
3LD2704-0TK53 + 3LD9280-0B	3LD2704-0TK53 + 3LD9280-0B + 3LD9200-5B	-	-
3LD2804-0TK53 + 3LD9280-0B	3LD2804-0TK53 + 3LD9280-0B + 3LD9200-5B	-	-
3LD2305-1TL13	3LD2305-1TL13 + 3LD9200-5B	3LD2305-3VK13	3LD2305-3VK13 + 3LD9200-5B
3LD2405-1TL13	3LD2405-1TL13 + 3LD9200-5B	3LD2405-3VK13	3LD2405-3VK13 + 3LD9200-5B
3LD2054-1TL53	3LD2054-2EP53	-	-
3LD2154-1TL53	3LD2154-2EP53	-	-
3LD2254-1TL53	3LD2254-1TL53 + 3LD9200-5B	-	-
3LD2555-0TK53 + 3LD9250-0BA	3LD2555-0TK53 + 3LD9250-0BA + 3LD9200-5B	-	-
3LD2022-1TL13	3LD2022-1TL13 + 3LD9200-5B	-	-
3LD2122-1TL13	3LD2122-1TL13 + 3LD9200-5B	-	-
3LD2222-0TK13 + 3LD9220-0B	3LD2222-0TK13 + 3LD9220-0B + 3LD9200-5B	-	-
3LD2050-1TL13	3LD2050-1TL13 + 3LD9200-5B	-	-
3LD2150-0TK13 + 3LD9220-0B	3LD2150-0TK13 + 3LD9220-0B + 3LD9200-5B	-	-
3LD2250-0TK13 + 3LD9220-0B	3LD2250-0TK13 + 3LD9220-0B + 3LD9200-5B	-	-

Disconnect Switches

3LD switch disconnectors

3LD2 accessories for front mounting

Accessories for front mounting





			3LD20 (16 A)	3LD21 (25 A)	3LD22 (32 A)	3LD25 (63 A)	3LD27 (100 A)	3LD28 (125 A)	3LD23 (160 A)	3LD24 (250 A)	
Switching contacts for N conductor (4th contact)											
	Contacts	Catalog No.									
	Leading switch-on, lagging switch-off	3LD9220-0B		■	■						
		3LD9250-0BA				■					
		3LD9280-0B					■	■			
		3LD9240-0B							■	■	
N/PE terminals											
	Contacts	Catalog No.									
	Through-type	3LD9200-2B		■							
		3LD9220-2B			■	■					
		3LD9250-2BA					■				
		3LD9280-2B						■	■		
3LD9240-2B									■	■	
Auxiliary switches (standard version)											
	<ul style="list-style-type: none"> For mounting on the left and/or right Lagging switch-on, leading switch-off 										
	Contacts	Contact surface	Catalog No.								
	1 NO + 1 NC	Standard	3LD9200-5B	■	■	■	■	■	■	■	■
Gold-plated		3LD9200-5BF	■	■	■	■	■	■	■	■	
Auxiliary switch for mounting on the front											
	<ul style="list-style-type: none"> Mounted on the switch shaft For four-hole front mounting and panel mounting only For long leading times (20 ... 150 m) Not for 6-pole 3LD23 (160 A) and 3LD24 (250 A) 										
	Contacts	Contact surface	Catalog No.								
	1 NO + 1 NC	Standard	3LD9280-5D	■	■	■	■	■	■		■
		Gold-plated	3LD9240-5D new								■
3LD9280-5DF				■	■	■	■	■	■		
		3LD9240-5DF							■	■	
Rotary operating mechanisms											
	<ul style="list-style-type: none"> Lockable in 0 position with up to 3 padlocks 										
	Version	Mounting	Catalog No.								
	For main control switches	Center-hole mounting	3LD9224-1D	■	■	■					
			3LD9284-1D				■				
		Four-hole mounting	3LD9224-1B	■	■	■					
			3LD9284-1B				■	■	■		
	For EMERGENCY-STOP switches	Center-hole mounting	3LD9224-3D	■	■	■					
			3LD9284-3D				■				
		Four-hole mounting	3LD9224-3B	■	■	■					
3LD9284-3B						■	■	■			

Disconnect Switches

3LD switch disconnectors

3LD2 accessories for front mounting

Accessories for front mounting

		3LD20 (16 A)	3LD21 (25 A)	3LD22 (32 A)	3LD25 (63 A)	3LD27 (100 A)	3LD28 (125 A)	3LD23 (160 A)	3LD24 (250 A)	
Knob-operated mechanisms										
	<ul style="list-style-type: none"> Lockable in 0 position with up to 3 padlocks 									
	Version	Mounting	Catalog No.							
	For main control switches	Four-hole mounting	3LD9243-1B						■	■
	For EMERGENCY-STOP switches	Four-hole mounting	3LD9243-3B						■	■
Terminal covers										
	<ul style="list-style-type: none"> Pack of 4 units 									
	Number of poles		Catalog No.							
	1-pole		3LD9201-2A	■						
			3LD9221-2A		■	■				
			3LD9251-2A				■			
			3LD9281-2A					■	■	
			3LD9241-2A						■	■
	3-pole		3LD9221-0A		■	■				
			3LD9251-0A				■			
	4-pole		3LD9201-1A	■						
Inscription labels										
	<ul style="list-style-type: none"> Pack of 10 units 									
	Inscription		Catalog No.							
	German / English (Hauptschalter / Main Switch)		3LD9286-1A	■	■	■	■	■	■	
Without inscription		3LD9286-4A	■	■	■	■	■	■		
Assembly tools										
	<ul style="list-style-type: none"> For center-hole mounting with nut Pack of 5 units 									
	Version	Catalog No.	3LD9256-0A	■	■	■	■			

Disconnect Switches

3LD switch disconnectors

3LD2 main control switches, panel mounting, 25 ... 50 kA_{eff}

3LD2 main control switches, panel mounting



Operating mechanisms, black

Number of poles 3P

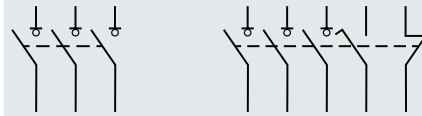

Uninterrupted current I _u At AC-21A, 380 ... 440 V	Operational power P At AC-23A, 380 ... 440 V	Operational power P At AC-3A, 380 ... 440 V	Without auxiliary switch	1 NO + 1 NC (standard version)
Door-coupling rotary operating mechanism, four-hole mounting				
16 A	7.5 kW	5.5 kW	3LD2013-0TK51	3LD2013-0TK51 + 3LD9200-5C
25 A	9.5 kW	7.5 kW	3LD2113-0TK51	3LD2113-0TK51 + 3LD9200-5C
32 A	11.5 kW	9.5 kW	3LD2213-0TK51	3LD2213-0TK51 + 3LD9200-5C
63 A	22 kW	18.5 kW	3LD2514-0TK51	3LD2514-0TK51 + 3LD9200-5C
100 A	37 kW	30 kW	3LD2714-0TK51	3LD2714-0TK51 + 3LD9200-5C
125 A	45 kW	37 kW	3LD2814-0TK51	3LD2814-0TK51 + 3LD9200-5C
160 A	75 kW	50 kW	3LD2318-0TK11	3LD2318-0TK11 + 3LD9200-5C
250 A	132 kW	110 kW	3LD2418-0TK11	3LD2418-0TK11 + 3LD9200-5C
Door-coupling rotary operating mechanism, center-hole mounting Ø 22.5 mm				
16 A	7.5 kW	5.5 kW	3LD2044-0TK51	3LD2044-0TK51 + 3LD9200-5C
25 A	9.5 kW	7.5 kW	3LD2144-0TK51	3LD2144-0TK51 + 3LD9200-5C
32 A	11.5 kW	9.5 kW	3LD2244-0TK51	3LD2244-0TK51 + 3LD9200-5C
63 A	22 kW	18.5 kW	3LD2545-0TK51	3LD2545-0TK51 + 3LD9200-5C
Defeatable door-coupling knob-operated mechanism, four-hole mounting				
16 A	7,5 kW	5,5 kW	3LD2017-0TK11	3LD2017-0TK11 + 3LD9200-5C
32 A	11,5 kW	9,5 kW	3LD2217-0TK11	3LD2217-0TK11 + 3LD9200-5C
63 A	22 kW	18,5 kW	3LD2517-0TK11	3LD2517-0TK11 + 3LD9200-5C

Scope of supply:

- Including terminal covers for the infeed side
- Up to 125 A with integrated tolerance compensation

Mounting:

- Up to 125 A using screws or snap-on mounting on 35 mm mounting rails

Accessories, see pages 18/60 to 18/61

Disconnect Switches

3LD switch disconnectors

3LD2 main control switches, panel mounting, 25 ... 50 kA_{eff}



3P+N

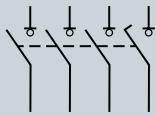

Without auxiliary switch

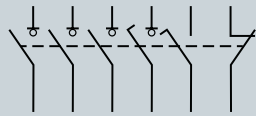

1 NO + 1 NC (standard version)

6P

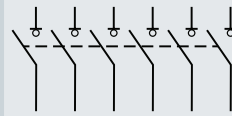

Without auxiliary switch

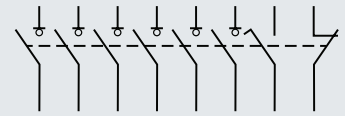

1 NO + 1 NC (standard version)

3LD2013-1TL51	3LD2013-1TL51	+ 3LD9200-5C	-	-
3LD2113-1TL51	3LD2113-1TL51	+ 3LD9200-5C	3LD2113-3VK51	3LD2113-4VP51
3LD2213-1TL51	3LD2213-1TL51	+ 3LD9200-5C	-	-
3LD2514-1TL51	3LD2514-1TL51	+ 3LD9200-5C	-	-
3LD2714-0TK51 + 3LD9280-0C	3LD2714-0TK51 + 3LD9280-0C	+ 3LD9200-5C	-	-
3LD2814-0TK51 + 3LD9280-0C	3LD2814-0TK51 + 3LD9280-0C	+ 3LD9200-5C	-	-
3LD2318-1TL11	3LD2318-1TL11	+ 3LD9200-5C	3LD2318-3VK11	3LD2318-3VK11 + 3LD9200-5C
3LD2418-1TL11	3LD2418-1TL11	+ 3LD9200-5C	3LD2418-3VK11	3LD2418-3VK11 + 3LD9200-5C
3LD2044-1TL51	3LD2044-1TL51	+ 3LD9200-5C	-	-
3LD2144-1TL51	3LD2144-1TL51	+ 3LD9200-5C	-	-
3LD2244-1TL51	3LD2244-1TL51	+ 3LD9200-5C	-	-
3LD2545-0TK51 + 3LD9250-0CA	3LD2545-0TK51 + 3LD9250-0CA	+ 3LD9200-5C	-	-
3LD2017-1TL11	3LD2017-1TL11 + 3LD9200-5C		-	-
3LD2217-1TL11	3LD2217-1TL11 + 3LD9200-5C		-	-
3LD2517-1TL11	3LD2517-1TL11 + 3LD9200-5C		-	-

Disconnect Switches

3LD switch disconnectors

3LD2 EMERGENCY-STOP switches, panel mounting, 25 ... 50 kA_{eff}

3LD2 EMERGENCY-STOP switches, panel mounting



Operating mechanisms, red/yellow

Number of poles 3P

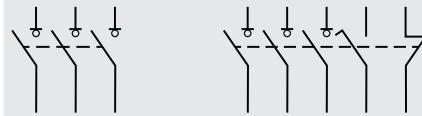

Uninterrupted current I _u At AC-21A, 380 ... 440 V	Operational power P At AC-23A, 380 ... 440 V	Operational power P At AC-3A, 380 ... 440 V	Without auxiliary switch	1 NO + 1 NC (standard version)
Door-coupling rotary operating mechanism, four-hole mounting				
16 A	7.5 kW	5.5 kW	3LD2013-0TK53	3LD2013-0TK53 + 3LD9200-5C
25 A	9.5 kW	7.5 kW	3LD2113-0TK53	3LD2113-0TK53 + 3LD9200-5C
32 A	11.5 kW	9.5 kW	3LD2213-0TK53	3LD2213-0TK53 + 3LD9200-5C
63 A	22 kW	18.5 kW	3LD2514-0TK53	3LD2514-0TK53 + 3LD9200-5C
100 A	37 kW	30 kW	3LD2714-0TK53	3LD2714-0TK53 + 3LD9200-5C
125 A	45 kW	37 kW	3LD2814-0TK53	3LD2814-0TK53 + 3LD9200-5C
160 A	75 kW	50 kW	3LD2318-0TK13	3LD2318-0TK13 + 3LD9200-5C
250 A	132 kW	110 kW	3LD2418-0TK13	3LD2418-0TK13 + 3LD9200-5C
Door-coupling rotary operating mechanism, center-hole mounting Ø 22.5 mm				
16 A	7.5 kW	5.5 kW	3LD2044-0TK53	3LD2044-0TK53 + 3LD9200-5C
25 A	9.5 kW	7.5 kW	3LD2144-0TK53	3LD2144-0TK53 + 3LD9200-5C
32 A	11.5 kW	9.5 kW	3LD2244-0TK53	3LD2244-0TK53 + 3LD9200-5C
63 A	22 kW	18.5 kW	3LD2545-0TK53	3LD2545-0TK53 + 3LD9200-5C
Defeatable door-coupling knob-operated mechanism, four-hole mounting				
16 A	7,5 kW	5,5 kW	3LD2017-0TK13	3LD2017-0TK13 + 3LD9200-5C
32 A	11,5 kW	9,5 kW	3LD2217-0TK13	3LD2217-0TK13 + 3LD9200-5C
63 A	22 kW	18,5 kW	3LD2517-0TK13	3LD2517-1TL13 + 3LD9200-5C

Scope of supply:

- Including terminal covers for the infeed side
- Up to 125 A with integrated tolerance compensation

Mounting:

- Up to 125 A using screws or snap-on mounting on 35 mm mounting rails

Accessories, see pages 18/60 to 18/61

Disconnect Switches

3LD switch disconnectors

3LD2 EMERGENCY-STOP switches, panel mounting, 25 ... 50 kA_{eff}



3P+N

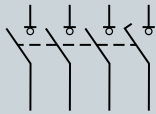

Without auxiliary switch

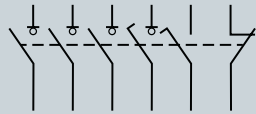

1 NO + 1 NC (standard version)

6P

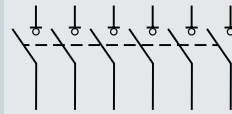

Without auxiliary switch

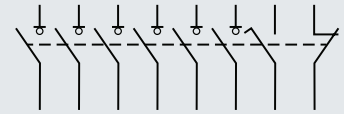

1 NO + 1 NC (standard version)







3LD2013-1TL53	3LD2013-1TL53	+ 3LD9200-5C	-	-
3LD2113-1TL53	3LD2113-1TL53	+ 3LD9200-5C	3LD2113-3VK53	3LD2113-4VP53
3LD2213-1TL53	3LD2213-1TL53	+ 3LD9200-5C	-	-
3LD2514-1TL53	3LD2514-1TL53	+ 3LD9200-5C	-	-
3LD2714-0TK53 + 3LD9280-0C	3LD2714-0TK53 + 3LD9280-0C	+ 3LD9200-5C	-	-
3LD2814-0TK53 + 3LD9280-0C	3LD2814-0TK53 + 3LD9280-0C	+ 3LD9200-5C	-	-
3LD2318-1TL13	3LD2318-1TL13	+ 3LD9200-5C	3LD2318-3VK13	3LD2318-3VK13 + 3LD9200-5C
3LD2418-1TL13	3LD2418-1TL13	+ 3LD9200-5C	3LD2418-3VK13	3LD2418-3VK13 + 3LD9200-5C
3LD2044-1TL53	3LD2044-1TL53	+ 3LD9200-5C	-	-
3LD2144-1TL53	3LD2144-1TL53	+ 3LD9200-5C	-	-
3LD2244-1TL53	3LD2244-1TL53	+ 3LD9200-5C	-	-
3LD2545-0TK53 + 3LD9250-0CA	3LD2545-0TK53 + 3LD9250-0CA	+ 3LD9200-5C	-	-
3LD2017-1TL13	3LD2017-1TL13 + 3LD9200-5C		-	-
3LD2217-1TL13	3LD2217-0TK13 + 3LD9200-5C		-	-
3LD2517-1TL13	3LD2517-1TL13 + 3LD9200-5C		-	-

Disconnect Switches

3LD switch disconnectors

3LD2 accessories for panel mounting

Accessories for panel mounting







				3LD20 (16 A)	3LD21 (25 A)	3LD22 (32 A)	3LD25 (63 A)	3LD27 (100 A)	3LD28 (125 A)	3LD23 (160 A)	3LD24 (250 A)	
Switching contacts for N conductor (4th contact)												
	Contacts	Catalog No.										
	Leading switch-on, lagging switch-off	3LD9220-0C		■	■							
		3LD9250-0CA				■						
		3LD9280-0C					■	■				
		3LD9240-0C								■	■	
N/PE terminals												
	Contacts	Catalog No.										
	Through-type	3LD9200-2C		■								
		3LD9220-2C			■	■						
		3LD9250-2CA					■					
		3LD9280-2C						■	■			
3LD9240-2C									■	■		
Auxiliary switches (standard version)												
	<ul style="list-style-type: none"> For mounting on the left and/or right Lagging switch-on, leading switch-off 											
	Contacts	Contact surface	Catalog No.									
	1 NO + 1 NC	Standard	3LD9200-5C		■	■	■	■	■	■	■	■
		Gold-plated	3LD9200-5CF		■	■	■	■	■	■	■	■
	2 NO	Standard	3LD9200-6C		■	■	■	■	■	■	■	
Auxiliary switch for mounting on the front												
	<ul style="list-style-type: none"> Mounted on the switch shaft For long leading times (20 ... 150 ms) 											
	Contacts	Contact surface	Catalog No.									
	1 NO + 1 NC	Standard	3LD9280-5D		■	■	■	■	■	■		
			3LD9240-5D								■	■
		Gold-plated	3LD9280-5DF		■	■	■	■	■	■		
		3LD9240-5DF								■	■	
Rotary operating mechanisms												
<ul style="list-style-type: none"> Lockable in 0 position with up to 3 padlocks 												
	Version	Mounting	Catalog No.									
	For main control switches	Center-hole mounting	3LD9224-1D		■	■	■					
			3LD9284-1D				■					
		Four-hole mounting	3LD9224-1B		■	■	■					
			3LD9284-1B					■	■	■		
	For EMERGENCY-STOP switches	Center-hole mounting	3LD9224-3D		■	■	■					
			3LD9284-3D				■					
		Four-hole mounting	3LD9224-3B		■	■	■					
3LD9284-3B							■	■	■			
Knob-operated mechanisms												
<ul style="list-style-type: none"> Lockable in 0 position with up to 3 padlocks 												
	Version	Mounting	Catalog No.									
	For main control switches	Four-hole mounting	3LD9243-1B							■	■	
	For EMERGENCY-STOP switches	Four-hole mounting	3LD9243-3B							■	■	

Disconnect Switches

3LD switch disconnectors

3LD2 accessories for panel mounting

Accessories for panel mounting

				3LD20 (16 A)	3LD21 (25 A)	3LD22 (32 A)	3LD25 (63 A)	3LD27 (100 A)	3LD28 (125 A)	3LD23 (160 A)	3LD24 (250 A)	
8UC7.. door-coupling rotary operating mechanisms												
	<ul style="list-style-type: none"> To achieve defeatability from 3LD27 (100 A) to 3LD24 (250 A) 											
	Type	Version	Catalog No.									
	8UC71	Standard	8UC7110-1BB					■	■			
		EMERGENCY-STOP	8UC7120-3BB					■	■			
8UC72	Standard	8UC7210-1BB								■	■	
	EMERGENCY-STOP	8UC7220-3BB								■	■	
Coupling drivers												
	Version	Catalog No.										
	For 8UC71 door-coupling rotary operating mechanisms	8UC6011						■	■			
	For 8UC72 door-coupling rotary operating mechanisms	8UC6012								■	■	
Switching shafts												
	Cross-section	Length	Catalog No.									
	6 × 6 mm	300 mm	3LD9205-0C	■	■	■	■	■	■			
		600 mm	3LD9205-2C	■	■	■	■	■	■			
	8 × 8 mm	300 mm	3LD9245-0C								■	■
600 mm		3LD9245-2C								■	■	
Coupling pieces												
	<ul style="list-style-type: none"> Without ON-lock 											
	Catalog No.											
		3LD9242-4F								■	■	
Terminal covers												
	<ul style="list-style-type: none"> Pack of 4 units 											
	Number of poles	Catalog No.										
	1-pole	3LD9201-2A	■									
		3LD9221-2A		■	■							
		3LD9251-2A				■						
		3LD9281-2A					■	■				
		3LD9241-2A									■	■
	3-pole	3LD9221-0A		■	■							
		3LD9251-0A				■						
	4-pole	3LD9201-1A	■									
Inscription labels												
	<ul style="list-style-type: none"> Pack of 10 units Cannot be used with defeatable 3LD2.17 door-coupling rotary operating mechanisms 											
	Inscription	Catalog No.										
	German / English (Hauptschalter / Main Switch)	3LD9286-1A	■	■	■	■	■	■	■			
	Without inscription	3LD9286-4A	■	■	■	■	■	■	■			
Assembly tools												
	<ul style="list-style-type: none"> For center-hole mounting with nut Pack of 5 units 											
	Version	Catalog No.										
	For main control switches and EMERGENCY-STOP switches	3LD9256-0A	■	■	■	■						

Disconnect Switches

3LD switch disconnectors

3LD2 main control switches, installation in distribution boards, 25 ... 50 kA_{eff}

3LD2 main control switches, installation in distribution boards



Operating mechanisms, black

Number of poles 3P

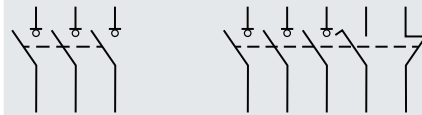

Uninterrupted current I _U At AC-21A, 380 ... 440 V	Operational power P At AC-23A, 380 ... 440 V	Operational power P At AC-3A, 380 ... 440 V	Without auxiliary switch	1 NO + 1 NC (standard version)
Knob-operated mechanisms with masking plate				
16 A	7.5 kW	5.5 kW	3LD2030-0TK11	3LD2030-0TK11 + 3LD9200-5C
25 A	9.5 kW	7.5 kW	3LD2130-0TK11	3LD2130-0TK11 + 3LD9200-5C
32 A	11.5 kW	9.5 kW	3LD2230-0TK11	3LD2230-0TK11 + 3LD9200-5C
63 A	22 kW	18.5 kW	3LD2530-0TK11	3LD2530-0TK11 + 3LD9200-5C
100 A	37 kW	30 kW	3LD2730-0TK11	3LD2730-0TK11 + 3LD9200-5C
125 A	45 kW	37 kW	3LD2830-0TK11	3LD2830-0TK11 + 3LD9200-5C
160 A	75 kW	50 kW	3LD2330-0TK11	3LD2330-0TK11 + 3LD9200-5C
250 A	132 kW	110 kW	3LD2430-0TK11	3LD2430-0TK11 + 3LD9200-5C

Scope of supply:

- 3LD23/3LD24 including terminal covers for the infeed side

Mounting:

- Up to 125 A using screws or snap-on mounting on 35 mm mounting rails
- Up to 125 A cap and mounting dimensions acc. to DIN 43880

Accessories

	3LD20 (16 A)	3LD21 (25 A)	3LD22 (32 A)	3LD25 (63 A)	3LD27 (100 A)	3LD28 (125 A)	3LD23 (160 A)	3LD24 (250 A)
--	-----------------	-----------------	-----------------	-----------------	------------------	------------------	------------------	------------------

Switching contacts for N conductor (4th contact)

Contacts	Catalog No.							
	Leading switch-on, lagging switch-off	3LD9220-0C	■	■				
	3LD9250-0CA			■				
	3LD9280-0C				■	■		
	3LD9240-0C						■	■

N/PE terminals

Contacts	Catalog No.							
	Through-type	3LD9200-2C	■					
	3LD9220-2C		■	■				
	3LD9250-2CA			■				
	3LD9280-2C				■	■		
	3LD9240-2C						■	■

Auxiliary switches (standard version)

 <ul style="list-style-type: none"> • For mounting on the left and/or right • Lagging switch-on, leading switch-off 									
	Contacts	Contact surface	Catalog No.						
1 NO + 1 NC	Standard	3LD9200-5C	■	■	■	■	■	■	■
	Gold-plated	3LD9200-5CF	■	■	■	■	■	■	■
2 NO	Standard	3LD9200-6C	■	■	■	■	■	■	

Disconnect Switches

3LD switch disconnectors

3LD2 main control switches, installation in distribution boards, 25 ... 50 kA_{eff}



3P+N

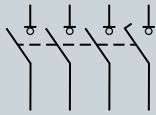

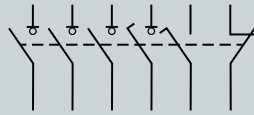

Without auxiliary switch



1 NO + 1 NC (standard version)

3LD2030-1TL11	3LD2030-1TL11	+ 3LD9200-5C
3LD2130-0TK11 + 3LD9220-0C	3LD2130-0TK11 + 3LD9220-0C	+ 3LD9200-5C
3LD2230-0TK11 + 3LD9220-0C	3LD2230-0TK11 + 3LD9220-0C	+ 3LD9200-5C
3LD2530-0TK11 + 3LD9250-0CA	3LD2530-0TK11 + 3LD9250-0CA	+ 3LD9200-5C
3LD2730-0TK11 + 3LD9280-0C	3LD2730-0TK11 + 3LD9280-0C	+ 3LD9200-5C
3LD2830-0TK11 + 3LD9280-0C	3LD2830-0TK11 + 3LD9280-0C	+ 3LD9200-5C
3LD2330-0TK11 + 3LD9240-0C	3LD2330-0TK11 + 3LD9240-0C	+ 3LD9200-5C
3LD2430-0TK11 + 3LD9240-0C	3LD2430-0TK11 + 3LD9240-0C	+ 3LD9200-5C

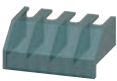
		3LD20 (16 A)	3LD21 (25 A)	3LD22 (32 A)	3LD25 (63 A)	3LD27 (100 A)	3LD28 (125 A)	3LD23 (160 A)	3LD24 (250 A)
Terminal covers									
• Pack of 4 units									
Number of poles		Catalog No.							
	1-pole	3LD9201-2A	3LD9221-2A	3LD9251-2A	3LD9281-2A	3LD9241-2A			
	3-pole								
	4-pole								

Disconnect Switches

3LD switch disconnectors

3LD2 EMERGENCY-STOP switches, installation in distribution boards, 25 ... 50 kA_{eff}

3LD2 EMERGENCY-STOP switches, installation in distribution boards



Operating mechanisms, red/yellow

Number of poles 3P

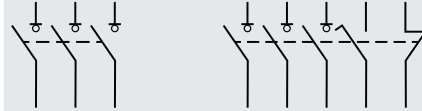

Uninterrupted current I _u At AC-21A, 380 ... 440 V	Operational power P At AC-23A, 380 ... 440 V	Operational power P At AC-3A, 380 ... 440 V	Without auxiliary switch	1 NO + 1 NC (standard version)
Knob-operated mechanisms with masking plate				
16 A	7.5 kW	5.5 kW	3LD2030-0TK13	3LD2030-0TK13 + 3LD9200-5C
25 A	9.5 kW	7.5 kW	3LD2130-0TK13	3LD2130-0TK13 + 3LD9200-5C
32 A	11.5 kW	9.5 kW	3LD2230-0TK13	3LD2230-0TK13 + 3LD9200-5C
63 A	22 kW	18.5 kW	3LD2530-0TK13	3LD2530-0TK13 + 3LD9200-5C
100 A	37 kW	30 kW	3LD2730-0TK13	3LD2730-0TK13 + 3LD9200-5C
125 A	45 kW	37 kW	3LD2830-0TK13	3LD2830-0TK13 + 3LD9200-5C
160 A	75 kW	50 kW	3LD2330-0TK13	3LD2330-0TK13 + 3LD9200-5C
250 A	132 kW	110 kW	3LD2430-0TK13	3LD2430-0TK13 + 3LD9200-5C

Scope of supply:

- 3LD23/3LD24 including terminal covers for the infeed side

Mounting:

- Up to 125 A using screws or snap-on mounting on 35 mm mounting rails
- Up to 125 A cap and mounting dimensions acc. to DIN 43880

Accessories

3LD20 (16 A)	3LD21 (25 A)	3LD22 (32 A)	3LD25 (63 A)	3LD27 (100 A)	3LD28 (125 A)	3LD23 (160 A)	3LD24 (250 A)
-----------------	-----------------	-----------------	-----------------	------------------	------------------	------------------	------------------

Switching contacts for N conductor (4th contact)

Contacts	Catalog No.	3LD20	3LD21	3LD22	3LD25	3LD27	3LD28	3LD23	3LD24
Leading switch-on, lagging switch-off	3LD9220-0C		■	■					
	3LD9250-0CA				■		■		
	3LD9280-0C					■		■	
	3LD9240-0C							■	■

N/PE terminals

Contacts	Catalog No.	3LD20	3LD21	3LD22	3LD25	3LD27	3LD28	3LD23	3LD24
Through-type	3LD9200-2C	■							
	3LD9220-2C		■	■					
	3LD9250-2CA				■				
	3LD9280-2C					■	■		
	3LD9240-2C							■	■

Auxiliary switches (standard version)

Contacts	Contact surface	Catalog No.	3LD20	3LD21	3LD22	3LD25	3LD27	3LD28	3LD23	3LD24
1 NO + 1 NC	Standard	3LD9200-5C	■	■	■	■	■	■	■	■
	Gold-plated	3LD9200-5CF	■	■	■	■	■	■	■	■
2 NO	Standard	3LD9200-6C	■	■	■	■	■	■	■	

Terminal covers

Number of poles	Catalog No.	3LD20	3LD21	3LD22	3LD25	3LD27	3LD28	3LD23	3LD24
1-pole	3LD9201-2A	■							
	3LD9221-2A		■	■					
	3LD9251-2A				■				
	3LD9281-2A					■	■		
	3LD9241-2A							■	■
3-pole	3LD9221-0A		■	■					
	3LD9251-0A				■				
4-pole	3LD9201-1A	■							

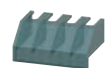

Disconnect Switches

3LD switch disconnectors

3LD2 EMERGENCY-STOP switches, installation in distribution boards, 25 ... 50 kA_{eff}



3+N

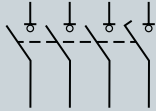

Without auxiliary switch

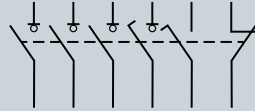

1 NO + 1 NC (standard version)

3LD2030-1TL13	3LD2030-1TL13	+ 3LD9200-5C
3LD2130-0TK13 + 3LD9220-0C	3LD2130-0TK13 + 3LD9220-0C	+ 3LD9200-5C
3LD2230-0TK13 + 3LD9220-0C	3LD2230-0TK13 + 3LD9220-0C	+ 3LD9200-5C
3LD2530-0TK13 + 3LD9250-0CA	3LD2530-0TK13 + 3LD9250-0CA	+ 3LD9200-5C
3LD2730-0TK13 + 3LD9280-0C	3LD2730-0TK13 + 3LD9280-0C	+ 3LD9200-5C
3LD2830-0TK13 + 3LD9280-0C	3LD2830-0TK13 + 3LD9280-0C	+ 3LD9200-5C
3LD2330-0TK13 + 3LD9240-0C	3LD2330-0TK13 + 3LD9240-0C	+ 3LD9200-5C
3LD2430-0TK13 + 3LD9240-0C	3LD2430-0TK13 + 3LD9240-0C	+ 3LD9200-5C

Disconnect Switches

3LD switch disconnectors

DC isolators, 50 kA_{rms}

DC isolators



Operating mechanisms, black

Number of poles 8P

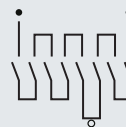

Mains voltage	Rated operational current I _e At DC-21A, 800 V DC	Rated operational current I _e At DC-22A, 800 V DC	Without auxiliary switch
800 V DC	32 A	16 A	3LD2230-8VQ11-0AF6

Knob-operated mechanisms

18





SWITCHES

Disconnect Switches



3LD switch disconnectors

Accessories for 3LD2 main control and EMERGENCY-STOP switches

Operating mechanisms

				3LD20 (16 A)	3LD21 (25 A)	3LD22 (32 A)	3LD25 (63 A)	3LD27 (100 A)	3LD28 (125 A)	3LD23 (160 A)	3LD24 (250 A)	
Rotary operating mechanisms												
 <ul style="list-style-type: none"> Lockable in 0 position with up to 3 padlocks Center-hole mounting, including seal and nut Four-hole mounting, including seal 	Switch	Mounting	Catalog No.									
	For main control switches	Center-hole mounting	3LD9224-1D	■	■	■						
		Four-hole mounting	3LD9224-1B	■	■	■	■	■	■			
			3LD9284-1B				■	■	■			
		For EMERGENCY-STOP switches	Center-hole mounting	3LD9224-3D	■	■	■					
	Four-hole mounting		3LD9284-3D				■	■	■			
			3LD9224-3B	■	■	■						
			3LD9284-3B				■	■	■			
Knob-operated mechanisms												
 <ul style="list-style-type: none"> Lockable in 0 position with up to 3 padlocks Including seal 	Switch	Mounting	Catalog No.									
	For main control switches	Four-hole mounting	3LD9243-1B							■	■	
	For EMERGENCY-STOP switches	Four-hole mounting	3LD9243-3B							■	■	
Switching shafts												
	Version	Cross-section	Length	Catalog No.								
	For panel mounting	6 × 6 mm	300 mm	3LD9205-0C	■	■	■	■	■	■		
			600 mm	3LD9205-2C	■	■	■	■	■	■		
		8 × 8 mm	300 mm	3LD9245-0C							■	■
			600 mm	3LD9245-2C							■	■
Coupling pieces												
 <ul style="list-style-type: none"> Without ON-lock 	Version	Catalog No.										
	For panel mounting	3LD9242-4F								■	■	

Other accessories

				3LD20 (16 A)	3LD21 (25 A)	3LD22 (32 A)	3LD25 (63 A)	3LD27 (100 A)	3LD28 (125 A)	3LD23 (160 A)	3LD24 (250 A)	
Terminal covers												
 <ul style="list-style-type: none"> Pack of 4 units 	Number of poles	Catalog No.										
	1-pole	3LD9201-2A	■									
		3LD9221-2A		■	■							
		3LD9251-2A				■						
		3LD9281-2A					■	■				
		3LD9241-2A									■	■
	3-pole	3LD9221-0A		■	■							
		3LD9251-0A				■						
	4-pole	3LD9201-1A	■									
	Inscription labels											
 <ul style="list-style-type: none"> Pack of 10 units 	Inscription	Catalog No.										
	German / English (Hauptschalter / Main Switch)	3LD9286-1A	■	■	■	■	■	■	■			
	Without inscription	3LD9286-4A	■	■	■	■	■	■	■			
Assembly tools												
 <ul style="list-style-type: none"> For center-hole mounting with nut Pack of 5 units 	Switch	Catalog No.										
	For main control switches and EMERGENCY-STOP switches	3LD9256-0A	■	■	■	■						

Disconnect Switches

3LD switch disconnectors

System overview of 3LD5 UL main control and EMERGENCY-STOP switches

Basic units for front mounting



3LD5020 (3-pole)



3LD5020 (4-pole)



3LD5420 (3-pole)



3LD5420 (4-pole)

Basic units, panel mounting with direct operating mechanism



3LD5000 (3-pole)



3LD5000 (4-pole)



3LD5400 (3-pole)



3LD5400 (4-pole)

Basic units, panel mounting with door-coupling rotary operating mechanism



3LD5010 (3-pole)



3LD5010 (4-pole)



3LD5410 (3-pole)



3LD5410 (4-pole)

Additional poles and auxiliary switches



N switching contact



N/PE terminals (through-type)



Auxiliary switches (standard version)



Auxiliary switch for mounting on the front

Operating mechanisms



Rotary operators for four-hole mounting



Coupling heads with and without tolerance compensation



Supplementary handles for UL508A/NFPA79



Switching shafts for UL508A/NFPA79

Other accessories



Terminal covers, 1-pole



Terminal covers, 3 and 4-pole



Inscription labels (with and without inscription)

Note:

You will find a detailed range of accessories with the basic units.

Mounting concept and accessories

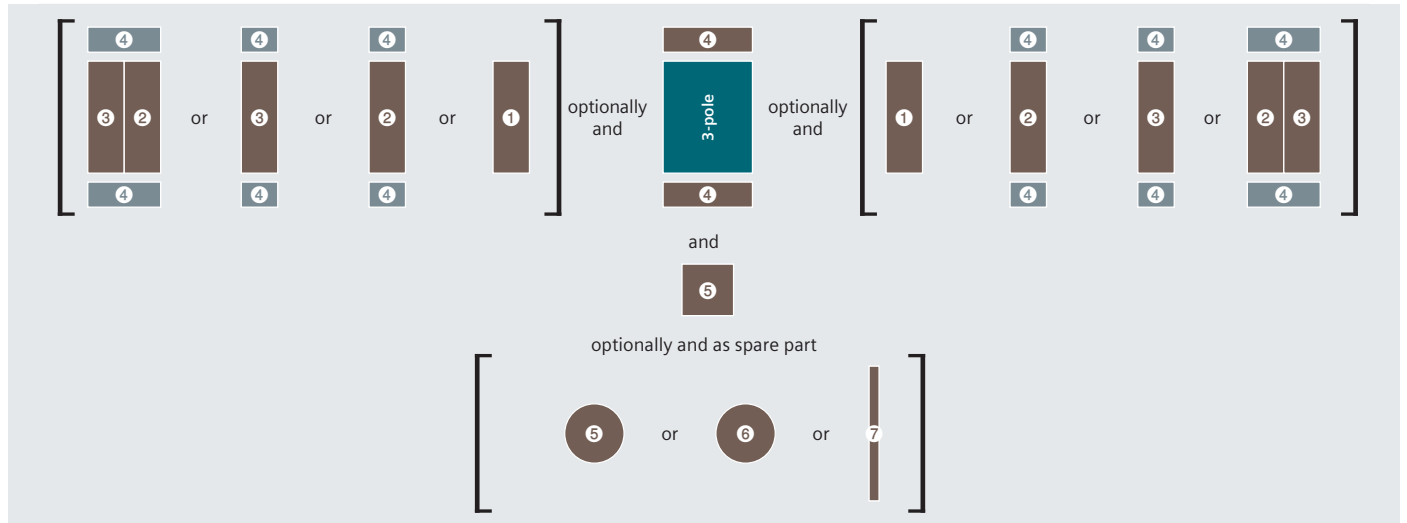

Legend

- 1 Auxiliary switch
- 2 N switching contact ¹⁾
- 3 N/PE terminal
- 4 Terminal cover
- 5 Rotary operating mechanism, four-hole mounting
- 6 Knob-operated mechanism, four-hole mounting
- 7 Switching shaft (300 oder 600 mm)

¹⁾ The N switching contact 2 first has to be mounted on the basic unit



Main control switches acc. to UL

The certification according to UL489 makes the 3LD5 UL ideal for use as a main control switch for machinery and plants for export to the NAFTA states. The variety of accessories makes it especially suitable as a main disconnect switch for industrial machinery. The switch is also certified according to UL508 and can also be used as a manual motor controller.

Mounting types

Front mounting of basic units



The switches for front mounting are mounted on the inside of covers, side panels or, if applicable, control cabinet doors (depending on the applicable standard and switching function). Installation is achieved by 4-hole mounting of the handle. This switch is especially suitable when door interlocking is not required or is implemented in a different way.

Panel mounting with direct operating mechanism



The switches for panel mounting with direct operating mechanism up to 30 A are snapped onto 35 mm standard mounting rails according to EN 60715 or screw-mounted on mounting panels. The switches for 100 to 160 A (3LD54 ... 3LD58) are exclusively screwed onto mounting panels.

Basic units, panel mounting with door-coupling rotary operating mechanism



The switches for panel mounting up to 30 A (3LD50) are snapped onto 35 mm standard mounting rails according to EN 60715 or screw-mounted on mounting panels. The switches for 100 to 160 A (3LD54 ... 3LD58) are exclusively screwed onto mounting panels. The actuators are connected to the lower section of the switch through a door coupling, which can be released in its zero position, and a 300 mm long switch shaft. The rotary operating mechanisms are also defeatable, i.e. it is possible to open the control cabinet door with a deliberate action while the switch is in the ON position. To meet the requirement acc. to UL508A/NFPA79, a supplementary handle can be mounted on the switch. Combined with the intermediate handle, the shaft can no longer be removed.

Disconnect Switches

3LD switch disconnectors

3LD5 UL main control and EMERGENCY-STOP switches, front mounting, SCCR 50 - 65 kA

3LD5 UL main control and EMERGENCY-STOP switches, front mounting



Operating mechanisms, black

Number of poles

3P

3P+N

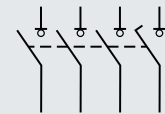
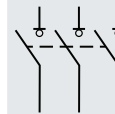

Uninterrupted current I_u At AC-21A, 380 ... 440 V	General use acc. UL489/60947-4-1	Operational power P At AC-23A, 380 ... 440 V	Operating mechanisms, black	
32	30	15	3LD5020-0TK11	3LD5020-0TL11
63	60	30	3LD5220-0TK11	3LD5220-0TL11
100	100	45	3LD5420-0TK11	3LD5420-0TL11
125	125	55	3LD5620-0TK11	3LD5620-0TL11
160	150	75	3LD5820-0TK11	3LD5820-0TL11

Scope of supply:

- Including terminal covers for the infeed side

Accessories for front mounting

		3LD50	3LD52	3LD54	3LD56	3LD58
Switching contacts for N conductor (4th contact)						
	Contacts	Catalog No.				
	Leading switch-on, lagging switch-off	3LD9250-0BA				
		3LD9280-0B				
		3LD9240-0B				
N/PE terminals						
	Contacts	Catalog No.				
	Through-type	3LD9250-2BA				
		3LD9280-2B				
		3LD9240-2B				
Auxiliary switches (standard version)						
	<ul style="list-style-type: none"> • For mounting on the left and/or right • Lagging switch-on, leading switch-off 					
	Contacts	Contact surface	Catalog No.			
	1 NO + 1 NC	Standard	3LD9200-5B			
		Gold-plated	3LD9200-5BF			
Auxiliary switch for mounting on the front						
	<ul style="list-style-type: none"> • Mounted on the front of the switch shaft • For long leading times (20 ... 150ms) 					
	Contacts	Contact surface	Catalog No.			
	1 NO + 1 NC	Standard	3LD9280-5D			
		Gold-plated	3LD9240-5D			
			3LD9280-5DF			
		3LD9240-5DF				
Rotary operating mechanisms						
	<ul style="list-style-type: none"> • Auxiliary switch for mounting on the front 					
	Version	Catalog No.				
	For main control switches	3LD9284-1B				
	For EMERGENCY-STOP switches	3LD9284-3B				

Disconnect Switches

3LD switch disconnectors

3LD5 UL main control and EMERGENCY-STOP switches, front mounting, SCCR 50 - 65 kA



Operating mechanisms, red/yellow

3P

3P+N

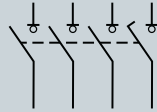
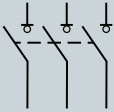

3LD5020-OTK13	3LD5020-OTL13
3LD5220-OTK13	3LD5220-OTL13
3LD5420-OTK13	3LD5420-OTL13
3LD5620-OTK13	3LD5620-OTL13
3LD5820-OTK13	3LD5820-OTL13

3LD50 3LD52 3LD54 3LD56 3LD58

Knob-operated mechanisms



- Lockable in 0 position with up to 3 padlocks

Version

For main control switches

For EMERGENCY-STOP switches

Catalog No.

3LD9243-1B

3LD9284-3B

Terminal covers

- Pack of 4 units

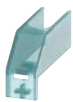

Number of poles

1-pole

3LD9251-2A

3LD9281-2A

3LD9241-2A

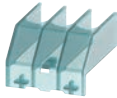

3-pole

3LD9251-0A

Inscription labels



- Pack of 10 units

Inscription

German / English (Hauptschalter / Main Switch)

Without inscription

Catalog No.

3LD9286-1A

3LD9286-4A

Disconnect Switches

3LD switch disconnectors

3LD5 UL main control and EMERGENCY-STOP switches, panel mounting, direct operating mechanism, SCCR 50 ... 65 kA

3LD5 UL main control and EMERGENCY-STOP switches, panel mounting with direct operating mechanism



Operating mechanisms, black

Number of poles

3P

3P+N

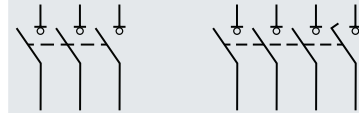

Uninterrupted current I_{U} At AC-21A, 380 ... 440 V	General use acc. UL489/508	Operational power P At AC-23A, 380 ... 440 V		
Rotary operating mechanism, four-hole mounting				
32	30	15	3LD5000-0TK11	3LD5000-0TL11
63	60	30	3LD5200-0TK11	3LD5200-0TL11
100	100	45	3LD5400-0TK11	3LD5400-0TL11
125	125	55	3LD5600-0TK11	3LD5600-0TL11
160	150	75	3LD5800-0TK11	3LD5800-0TL11

Scope of supply:

- Including terminal covers for the infeed side

Accessories for panel mounting with direct operating mechanisms

3LD50 3LD52 3LD54 3LD56 3LD58

			3LD50	3LD52	3LD54	3LD56	3LD58
Switching contacts for N conductor (4th contact)							
	Contacts	Catalog No.					
	Leading switch-on, lagging switch-off	3LD9250-OCA	■				
		3LD9280-0C		■			
		3LD9240-0C			■	■	■
N/PE terminals							
	Contacts	Catalog No.					
	Through-type	3LD9250-2CA	■				
		3LD9280-2C		■			
		3LD9240-2C			■	■	■
Auxiliary switches							
	<ul style="list-style-type: none"> • For mounting on the left and/or right • Lagging switch-on, leading switch-off 						
	Contacts	Contact surface	Catalog No.				
	1 NO + 1 NC	Standard	3LD9200-5C	■	■	■	■
		Gold-plated	3LD9200-5CF	■	■	■	■
Terminal covers							
	<ul style="list-style-type: none"> • Pack of 4 units 						
	Number of poles	Catalog No.					
	1-pole	3LD9251-2A	■				
		3LD9281-2A		■			
		3LD9241-2A			■	■	■
	3-pole	3LD9251-0A	■				

Disconnect Switches

3LD switch disconnectors

3LD5 UL main control and EMERGENCY-STOP switches, panel mounting, direct operating mechanism, SCCR 50 ... 65 kA



Operating mechanisms, red/yellow

3P

3P+N

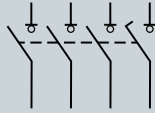
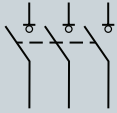

3LD5000-0TK13

3LD5000-0TL13

3LD5200-0TK13

3LD5200-0TL13

3LD5400-0TK13

3LD5400-0TL13

3LD5600-0TK13

3LD5600-0TL13

3LD5800-0TK13

3LD5800-0TL13

Disconnect Switches

3LD switch disconnectors

3LD5 UL main control and EMERGENCY-STOP switches, panel mounting, door-coupling rotary operating mechanism, SCCR 50 ... 65 kA

3LD5 UL main control and EMERGENCY-STOP switches, panel mounting with door-coupling rotary operating mechanism



Operating mechanisms, black

Number of poles

3P

3P+N



Uninterrupted current I_{cu} At AC-21A, 380 ... 440 V	General use acc. UL489/508	Operational power P At AC-23A, 380 ... 440 V		
Rotary operating mechanism, four-hole mounting				
32	30	15	3LD5010-0TK11	3LD5010-0TL11
63	60	30	3LD5210-0TK11	3LD5210-0TL11
100	100	45	3LD5410-0TK11	3LD5410-0TL11
125	125	55	3LD5610-0TK11	3LD5610-0TL11
160	150	75	3LD5810-0TK11	3LD5810-0TL11

Scope of supply:

- Including terminal covers for the infeed side
- Defeatable door-coupling rotary operating mechanisms
- Without tolerance compensation

Accessories for panel mounting with door mounted rotary operator

3LD50 3LD52 3LD54 3LD56 3LD58

Switching contacts for N conductor (4th contact)			3LD50	3LD52	3LD54	3LD56	3LD58
	Contacts	Catalog No.					
	Leading switch-on, lagging switch-off	3LD9250-0CA	■				
		3LD9280-0C		■			
		3LD9240-0C			■	■	■
N/PE terminals							
	Contacts	Catalog No.					
	Through-type	3LD9250-2CA	■				
		3LD9280-2C		■			
		3LD9240-2C			■	■	■
Auxiliary switches (standard version)							
	<ul style="list-style-type: none"> • For mounting on the left and/or right • Lagging switch-on, leading switch-off 						
	Contacts	Contact surface	Catalog No.				
	1 NO + 1 NC	Standard	3LD9200-5C	■	■	■	■
		Vergoldet	3LD9200-5CF	■	■	■	■
Auxiliary switch for mounting on the front							
	<ul style="list-style-type: none"> • Mounted on the front of the switch shaft • For long leading times (20 ... 150ms) 						
	Contacts	Contact surface	Catalog No.				
	1 NO + 1 NC	Standard	3LD9280-5D	■	■		
			3LD9240-5D			■	■
		Gold-plated	3LD9280-5DF	■	■		
		3LD9240-5DF			■	■	
Handles							
	<ul style="list-style-type: none"> • Supplied with a masking frame, but without an extension shaft or coupling driver • Can be locked with up to 3 padlocks 						
	Labeling	Color	Catalog No.				
	O-I	Gray	8UD1771-2AD01	■	■		
			8UD1731-2AD01			■	■
		Red/yellow	8UD1771-2AD05	■	■		
		8UD1731-2AD05			■	■	

Disconnect Switches

3LD switch disconnectors

3LD5 UL main control and EMERGENCY-STOP switches, panel mounting, direct operating mechanism, SCCR 50 ... 65 kA



Operating mechanisms, red/yellow

3P

3P+N



3LD5010-0TK13	3LD5010-0TL13
3LD5210-0TK13	3LD5210-0TL13
3LD5410-0TK13	3LD5410-0TL13
3LD5610-0TK13	3LD5610-0TL13
3LD5810-0TK13	3LD5810-0TL13

3LD50 3LD52 3LD54 3LD56 3LD58

Supplementary handles for door-coupling rotary operating mechanism



- For requirements according to UL508A/NFPA79
- Can be locked with up to 1 padlocks in 0 position
- Can only be switched on by deliberate action

Labeling	Color	Catalog No.	3LD50	3LD52	3LD54	3LD56	3LD58
O-I	Gray	3LD9287-1C	■	■			
		3LD9247-1C			■	■	■
	Red/yellow	3LD9287-3C	■	■			
		3LD9247-3C			■	■	■

Coupling drivers



Version	Catalog No.	3LD50	3LD52	3LD54	3LD56	3LD58
With tolerance compensation	8UD1900-1GA00	■	■			
	8UD1900-2GA00			■	■	■
Without tolerance compensation	8UD1900-1HA00	■	■			
	8UD1900-2HA00			■	■	■

Terminal covers

- Pack of 4 units



Number of poles	Catalog No.	3LD50	3LD52	3LD54	3LD56	3LD58
1-pole	3LD9251-2A	■				
	3LD9281-2A		■			
	3LD9241-2A			■	■	■
3-pole	3LD9251-0A	■				

Inscription labels



- Pack of 10 units

Inscription	Catalog No.	3LD50	3LD52	3LD54	3LD56	3LD58
German / English (Hauptschalter / Main Switch)	3LD9286-1A	■	■	■	■	■
Without inscription	3LD9286-4A	■	■	■	■	■

Switching shafts









section	Length	Catalog No.	3LD50	3LD52	3LD54	3LD56	3LD58
6 × 6 mm	300 mm	3LD9205-0C	■	■			
	600 mm	3LD9205-2C	■	■			
8 × 8 mm	300 mm	3LD9245-0C			■	■	■
	600 mm	3LD9245-2C			■	■	■

Disconnect Switches

3LD switch disconnectors



Accessories for 3LD5 UL main control and EMERGENCY-STOP switches

				3LD50	3LD52	3LD54	3LD56	3LD58
Additional poles								
Switching contacts for N conductor (4th contact) for front mounting								
	Contacts		Catalog No.					
	Leading switch-on, lagging switch-off		3LD9250-0BA	■				
			3LD9280-0B		■			
			3LD9240-0B			■	■	■
Switching contacts for N conductor (4th contact) for panel mounting								
	Contacts		Catalog No.					
	Leading switch-on, lagging switch-off		3LD9250-0CA	■				
			3LD9280-0C		■			
			3LD9240-0C			■	■	■
N/PE terminals for front mounting								
	Contacts		Catalog No.					
	Through-type		3LD9250-2BA	■				
			3LD9280-2B		■			
			3LD9240-2B			■	■	■
N/PE terminals for panel mounting								
	Contacts		Catalog No.					
	Through-type		3LD9250-2CA	■				
			3LD9280-2C		■			
			3LD9240-2C			■	■	■
Auxiliary switches (standard version) for front mounting								
	<ul style="list-style-type: none"> For mounting on the left and/or right Lagging switch-on, leading switch-off 							
	Contacts		Contact surface	Catalog No.				
	1 NO + 1 NC		Standard	3LD9200-5B	■	■	■	■
			Gold-plated	3LD9200-5BF	■	■	■	■
Auxiliary switches (standard version) for panel mounting								
	<ul style="list-style-type: none"> For mounting on the left and/or right Lagging switch-on, leading switch-off 							
	Contacts		Contact surface	Catalog No.				
	1 NO + 1 NC		Standard	3LD9200-5C	■	■	■	■
			Gold-plated	3LD9200-5CF	■	■	■	■
Auxiliary switch for mounting on the front								
	<ul style="list-style-type: none"> Mounted on the front of the switch shaft For long leading times (20 ... 150ms) 							
	Contacts		Contact surface	Catalog No.				
	1 NO + 1 NC		Standard	3LD9280-5D	■	■		
			Gold-plated	3LD9240-5D			■	■
			3LD9280-5DF	■	■			
			3LD9240-5DF			■	■	

Disconnect Switches

3LD switch disconnectors

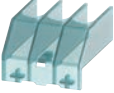
Accessories for 3LD5 UL main control and EMERGENCY-STOP switches

Operating mechanisms					3LD50	3LD52	3LD54	3LD56	3LD58
Rotary operating mechanism for front mounting									
	<ul style="list-style-type: none"> Lockable in 0 position with up to 3 padlocks 								
	Version	Catalog No.							
	For main control switches	3LD9284-1B			■	■			
	For EMERGENCY-STOP switches	3LD9284-3B			■	■			
Knob-operated mechanism for front mounting									
	<ul style="list-style-type: none"> Lockable in 0 position with up to 3 padlocks 								
	Version	Catalog No.							
	For main control switches	3LD9243-1B					■	■	■
	For EMERGENCY-STOP switches	3LD9284-3B					■	■	■
Handles for panel mounting									
	<ul style="list-style-type: none"> Supplied with a masking frame, but without an extension shaft or coupling driver Can be locked with up to 3 padlocks 								
	Labeling	Color	Catalog No.						
	O-I	Gray	8UD1771-2AD01		■	■			
		Red/yellow	8UD1731-2AD01				■	■	■
			8UD1771-2AD05		■	■			
			8UD1731-2AD05				■	■	■
Supplementary handles for door-coupling rotary operating mechanism									
	<ul style="list-style-type: none"> For requirements according to UL508A/NFPA79 Can be locked with up to 1 padlocks in 0 position Can only be switched on by deliberate action 								
	Labeling	Color	Catalog No.						
	O-I	Gray	3LD9287-1C		■	■			
		Red/yellow	3LD9247-1C				■	■	■
			3LD9287-3C		■	■			
			3LD9247-3C				■	■	■
Coupling drivers for panel mounting with door-coupling rotary operating mechanism									
	Version	Catalog No.							
	With tolerance compensation	8UD1900-1GA00			■	■			
		8UD1900-2GA00					■	■	■
	Without tolerance compensation	8UD1900-1HA00			■	■			
		8UD1900-2HA00					■	■	■
Other accessories					3LD50	3LD52	3LD54	3LD56	3LD58
Terminal covers									
	<ul style="list-style-type: none"> Pack of 4 units 								
	Number of poles	Catalog No.							
	1-pole	3LD9251-2A			■				
		3LD9281-2A				■			
		3LD9241-2A					■	■	■
	3-pole	3LD9251-0A			■				
Inscription labels									
	<ul style="list-style-type: none"> Pack of 10 units 								
	Inscription	Catalog No.							
	German / English (Hauptschalter / Main Switch)	3LD9286-1A			■		■	■	■
	Without inscription	3LD9286-4A			■		■	■	■
Switching shafts									
	section	Length	Catalog No.						
	6 × 6 mm	300 mm	3LD9205-0C		■	■			
		600 mm	3LD9205-2C		■	■			
	8 × 8 mm	300 mm	3LD9245-0C				■	■	■
		600 mm	3LD9245-2C				■	■	■

Disconnect Switches

3LD switch disconnectors

3LD2 Rotary Disconnect Switches in Non-Metallic Enclosures

Description

16–125A non-fusible switches are available in fiberglass reinforced polycarbonate enclosures which are UL approved as Type 12 & 4X and for either indoor or outdoor use. All are horsepower and load break rated. All are panel mounted and are either supplied with factory installed aux. contacts or will accept contact kits. All are compact in size while providing ample wiring space for copper line & load conductors.

Siemens Enclosed Rotary Disconnect Switches

- 16–125A, Non-Fusible
- 600VAC max. rated
- Available in both Type 12 and 4X non-metallic enclosures
- Listed and marked “suitable for use as motor disconnect” per NEC Section 430-109
- Switches are UL listed under File No. E47705 and are CSA certified under File No. 203576
- IEC 60947-3 rated and CE marked (enclosures are IP65 rated)
- HP rated
- 16–63A switches have factory installed ground bars.
- Switches are provided with knockouts
- Padlockable in OFF position with up to (3) padlocks
- Enclosures are constructed from Makrolon 9425.



Amp Rating	Catalog Number		Shipping Weight ^①	Horsepower Ratings			
	3 Pole, 3 Wire	3 Pole, 3 Wire with (1) NO & (1) NC Aux. Contact ^{②③}		240V AC		480V AC	600V AC
				1 Phase	3 Phase	3 Phase	3 Phase

Non-Fusible, Type 1, 4X & 12K[®] with Black Rotary Handle 600V AC Max.

16	3LD2064-0TB51-0US2	3LD2064-1GP51-0US2	1	1½	3	7½	10
25	3LD2164-0TB51-0US2	3LD2164-1GP51-0US2	1	3	7½	10	15
30	3LD2264-0TB51-0US2	3LD2264-1GP51-0US2	1	3	7½	15	20
30	—	3LD2264-1TS51-0US2 ^{④▲}	1	3	7½	15	20
30	—	3LD2264-2TW51-0US2 ^{④▲}	1	3	7½	15	20
63	3LD2565-0TB51-0US2	3LD2565-1GP51-0US2▲	3	10	15	40	50
100	3LD2766-0TB51-0US2	3LD2766-1GP51-0US2▲	6	—	30	60	75
125	3LD2866-0TB51-0US2	3LD2866-1GP51-0US2▲	6	—	40	75	100

Non-Fusible, Type 1, 4X & 12K[®] with Red and Yellow Rotary Handle 600V AC Max.

16	3LD2064-0TB53-0US2	3LD2064-1GP53-0US2	1	1½	3	7½	10
25	3LD2164-0TB53-0US2	3LD2164-1GP53-0US2	1	3	7½	10	15
30	3LD2264-0TB53-0US2	3LD2264-1GP53-0US2	1	3	7½	15	20
30	—	3LD2264-1TS53-0US2 ^{④▲}	1	3	7½	15	20
30	—	3LD2264-2TW53-0US2 ^{④▲}	1	3	7½	15	20
63	3LD2565-0TB53-0US2	3LD2565-1GP53-0US2▲	3	10	15	40	50
100	3LD2766-0TB53-0US2▲	3LD2766-1GP53-0US2▲	6	—	30	60	75
125	3LD2866-0TB53-0US2▲	3LD2866-1GP53-0US2▲	6	—	40	75	100

▲ Built to order. Allow 6–8 weeks for delivery.

① Carton quantity of (1). Shipping weight in pounds (lbs.).

② Approved for indoor/outdoor use. No cover interlock provided.

③ Switch is supplied with (2) NO and no NC aux. contacts.

④ Switch is supplied with (4) NO and no NC aux. contacts.

▲ Ground bar is not provided or available.

⑤ Aux. contacts break about 3 Ms before and make about 3 Ms after main switch contacts.

⑥ 6P, 25A, switch with 1 NO & 1 NC aux. contacts and a black operating handle is also available. Order catalog number 3LD2165-4VD51 (Discount Code: Pilot Devices).

Disconnect Switches

3LD switch disconnectors

3LD2 Rotary Disconnect Switches in Non-Metallic Enclosures

Enclosed Disconnect Switch Dimensions (Inches)

Catalog Number	Ampere Rating	Dimensions			
		A	B	C	D
3LD2064-	16	5.52 ^③	3.94	3.19	4.57
3LD2164-	25	5.52 ^③	3.94	3.19	4.57
3LD2264-	30	5.52 ^③	3.94	3.19	4.57
3LD2565-	63	6.93 ^③	5.75	4.10	5.87
3LD2766-	100	11.90	8.35	5.36	7.13
3LD2866-	125	11.90	8.35	5.36	7.13

Note: 3LD2 Type switches only have top and bottom end KOs as follows:
16-30A - 1/2" & 3/4", 63A - 3/4" & 1", 100 & 25A - 1" & 1 1/4"

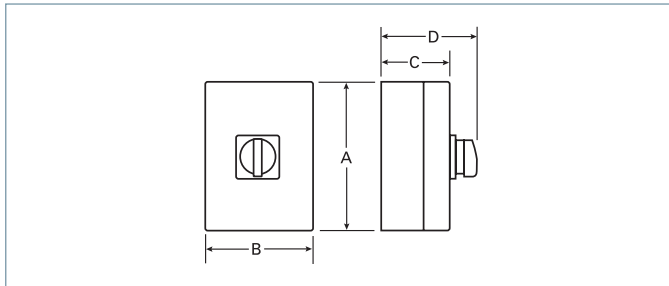

UL and CUL Short Circuit Withstand Ratings^③

Ampere Rating	Short Circuit Withstand Rating and Fuse Class				
	With Line Side Fusing			With Load Side Fusing ^①	
	5 kA at 600V Max	10 kA at 600V Max	18 kA at 480V Max	5 kA at 480V Max	18 kA at 480V Max
16	RK5 (50A Max)	—	—	—	—
25 & 30	RK5 (80A Max)	—	—	—	—
63	RK5 (175A Max)	—	—	—	—
100 & 125	—	RK5 (200A Max)	—	—	—

^① For use as supplemental protection on the load side of the branch circuit over current protective device.
^② Factory installed ground lugs supplied as follows: 16-30A #14-10 Cu, 63A #14-8 Cu. Ground lug not provided and is not available on catalog numbers 3LD2264-2TW51-0US2 and 3LD2264-2TW53-0US2.

Wire ranges 60/75°C Cu Only^②

16 Amps	(1) #18-10 AWG
25-30 Amps	(1) #14-10 AWG
63 Amps	(1) #14-6 AWG
100-125 Amps	(1) #12-1 AWG

IEC Fuse and Withstand Ratings

Ampere Rating	gG Fuse Size	Short Circuit Rating
16	20A	5k Arms
25	25A	10k Arms
32	50A	10k Arms
63	63A	15k Arms
100	100A	20k Arms
125	125A	20k Arms

Accessories^②

Switch Ampere Rating	Catalog Number	Description
16-30A	3LD9220-2C	Neutral Kit
63A	3LD9250-2CA	Neutral Kit
100-125A	3LD9280-2C	Neutral Kit

^③ 6.38 inches high including mounting feet.

^④ 7.85 inches high including mounting feet.

^⑤ 16-63A 3LD switches are also rated 5kA at 600VAC max when protected by a 3RV type MSP of the same or lesser ampere rating.

Disconnect Switches

Type VBII (30-600A) with Flange Mounted Operating Handle

Features and Ordering Information

Features

- 30-600A, 600VAC and DC ratings
- 240 & 600V AC switches are UL Recognized under file number E121152, Vol. 3 and CSA certified under file number 154852
- 600V DC Photovoltaic switches are UL Recognized under file number E335018, Vol. 3 and are rated to switch 3 separate 600V DC circuits
- Visible blade quick make and break switching action
- Panel and Flange mounted assemblies facilitate installation
- Panel mounted switches are variable depth
- Short circuit rating of 10,000 AIC with class H fuse, and of 200,000 AIC with class R or J fuses. PV switches are rated 10,000 AIC at 600V DC with 600V DC rated class K, J or R fuses.
- Flange mounted handles rated as Type 1, 3R & 12 or 4X are padlockable in the off position with up to (3) padlocks with 5/16 hasps
- Meets UL98 requirements and suitable for both main and branch circuit applications
- A complete line of aux contacts are available
- Load break and horsepower rated
- Defeatable cover interlock standard with all handles
- Meets NFPA79 requirements
- Seismic qualified — complies with the 2010 California Building Code (CBC) — and with the International Building Code (IBC) — Compliance Level SDS = 1.85 g



VBFS361, VBLK1 & VBH1



VBFS363F



VBNFS365, VBLK4 & VBH2

Ordering Information

1. Determine the ratings required (amps, volts, HP, Fusible, NF), the mounting needed (Panel or Flange), and select the appropriate switch.
2. For panel mounted switches with a rigid operating shaft (30-600A), order panel mounted switch, flange mounted operating handle & rigid linkage kit based on depth required.
3. For panel mounted switches with a Max-Flex operator, order panel mounted switch, Max-Flex Handle & Adapter Kit and drive cable.
4. Select accessories if required.

Disconnect Switches

Type VBII (30-600A) with Flange Mounted Operating Handle

Selection

Switches—for Standard 600V Max AC or DC Applications

Switch Ampere Rating	Max. AC Voltage Rating	Catalog Number	Horsepower Rating, Switches and 3-Phase ^④						600 Volts DC (max) ^④
			240 Volts AC		480 Volts AC		600 Volts AC		
			Standard	Max.	Standard	Max.	Standard	Max.	
Fusible Panel Mounted Variable Depth Switches - 3-Pole^⑤									
30	240	VBFS321	3	7 1/2	—	—	—	—	— ^①
60	240	VBFS322	7 1/2	15	—	—	—	—	— ^②
30	600	VBFS361	—	—	5	15	7 1/2	20	15 ^③
60	600	VBFS362	—	—	15	30	15	50	30 ^③
100	600	VBFS363	—	—	25	60	30	75	50 ^③
200	600	VBFS364	—	—	50	125	60	150	50
400	600	VBFS365	—	—	100	250	125	350	— ^⑨
600	600	VBFS366	—	—	150	400	200	500	— ^⑨
Non-fusible Panel Mounted Variable Depth Switches - 3-Pole^⑤									
30	600	VBNS361	—	10	—	20	—	30	15 ^③
60	600	VBNS362	—	20	—	50	—	60	30 ^③
100	600	VBNS363	—	40	—	75	—	100	50 ^③
200	600	VBNS364	—	60	—	125	—	150	50
400	600	VBNS365	—	125	—	250	—	300	— ^⑨
600	600	VBNS366	—	200	—	400	—	500	— ^⑨
Fusible Flange Mounted Switches - 3-Pole^{⑥⑦}									
30	240	VBFS321F	3	7 1/2	—	—	—	—	— ^①
60	240	VBFS322F	7 1/2	15	—	—	—	—	— ^②
30	600	VBFS361F	—	—	5	15	7 1/2	20	15 ^③
60	600	VBFS362F	—	—	15	30	15	50	30 ^③
100	600	VBFS363F	—	—	50	60	30	75	50 ^③
200	600	VBFS364F	—	—	100	125	60	150	50
Non-fusible Flange Mounted Switches - 3-Pole^{⑥⑦}									
30	600	VBNS361F	—	10	—	20	—	30	15 ^③
60	600	VBNS362F	—	20	—	50	—	60	30 ^③
100	600	VBNS363F	—	40	—	75	—	100	50 ^③
200	600	VBNS364F	—	60	—	125	—	150	50

Note: Fusible switches include fuse provisions for Class H Fuses. The load base can be moved to pre-drilled holes for Class J Fuses on all 600V switches. If Class R Fuses are required, add a Class R Fuse Clip Kit.

Switches—for Photovoltaic Applications, 600VDC Max.^⑦

(for use in negative ground systems only)

Switch Ampere Rating	Catalog Number	Rated Isc per NEC Article 690
Fusible Panel Mounted Variable Depth Switches—3 Pole^{⑧⑨}		
30	VBFS361PV	19.2A
60	VBFS362PV	38.4A
100	VBFS363PV	64.0A
Non-Fusible Panel Mounted Variable Depth Switches—3 Pole^⑧		
30	VBNS361PV	24.0A
60	VBNS362PV	48.0A
100	VBNS363PV	80.0A
Fusible Flange Mounted Variable Depth Switches—3 Pole (Includes Type 1, 3R and 12 Rated Operating Handle)^{⑧⑨}		
30	VBFS361FPV	19.2A
60	VBFS362FPV	38.4A
100	VBFS363FPV	64.0A
Non-Fusible Flange Mounted Variable Depth Switches—3 Pole (Includes Type 1, 3R and 12 Rated Operating Handle)^⑧		
30	VBNS361FPV	24.0A
60	VBNS362FPV	48.0A
100	VBNS363FPV	80.0A

- ① Rated 5 HP at 250V DC.
- ② Rated 10 HP at 250V DC.
- ③ 600V DC & 600V DC horsepower rating shown requires (2) poles to be connected in series.
- ④ Std. - applies when non-time delay fuses are used.
Max. - applies when time delay fuses are used.
- ⑤ Includes line base, load base, operating mechanism and line and load lugs.
Order operating handle and linkage kits from tables on pages 18/81 or 18/82.
- ⑥ Includes line base, load base, operating mechanism line and load lugs plastic operating handle and required linkage.
- ⑦ All photovoltaic switches are rated to be used with 3 separate 600V DC circuits.
- ⑧ Fusible switches accept Class K or R fuses as standard and Class J fuses by relocating the load base.
- ⑨ Rated 250V DC max and 50HP at 250V DC.
- ⑩ Please add letter "M" to the end of catalog number for metal handle.

Cable Kit

For use with 30-200A panel mounted switches and Max-Flex handle and adapter kit.

Catalog Number	Description
FHOEC036	36" long drive cable
FHOEC048	48" long drive cable

Max-Flex™ Handle and Adapter Kit

(Type 1, 12, 3R & 4X) Use with 30-200A panel mounted switches and cable kit.

Catalog Number	Operating Handle Description
Plastic Handles	
VBHM1	30-200A Type 1, 3R, 12 and 4X
Metal Handles	
VBHM2	30-200A Type 1, 3R and 12
VBHM2X	30-200A Type 4X

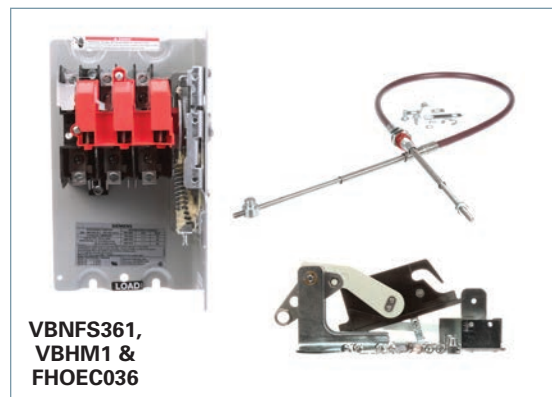

Disconnect Switches

Type VBII (30-600A) with Flange Mounted Operating Handle

Selection & Accessories

Flange Mounted Operating Handles

For use with Panel Mounted Switches. Plastic handle is included with Flange Mounted Switches as standard.

Catalog Number	Operating Handle Description
Plastic Handles	
VBH1	30-200A Type 1, 3R & 12
VBH14X	30-200A Type 4X
Metal Handles	
VBH112	30-200A Type 1, 3R & 12
VBH14	30-200A Type 4X
VBH2	400A Type 1 & 12
VBH2R	400 & 600A Type 1, 3R & 12
VBH24X	400 & 600A Type 4X



HR612

Class R Fuse Clip Kits

These kits prevent the installation of Class H and K fuses (one kit required per switch).

Class R Fuse Clip Kits

Catalog Number	Description
HR21	30A, 240V Kit (HD only)
HR612	30A, 600V Kit/60A, 240V Kit
HR62	60A, 600V Kit
HR63	100A Kit
HR64	200A Kit
HR656	400A/600A Kit

Internal Door Latch Kits

For use with enclosures with door mounted latching bar. Required when a flange mounted switch is mounted in a Hoffmann or Rittal enclosure provided with an AB cutout.

Catalog Number	Description
DKR2	2 point (for use with enclosures less than 40" high)
DKR3	3 point (for use with enclosures 40" or larger in height)

Rigid Linkage Kits

For use with Panel Mounted Switches. Not required for Flange Mounted Switches.

Catalog Number	Switch Ampere Rating	Enclosure Depth ^①	
		Min	Max.
VBLK1	30-200	6.94 ^②	6.94 ^②
VBLK2	30-200	6.94 ^②	19.0
VBLK3	400 & 600	9.00	8.75
VBLK4	400 & 600	9.00	19.0



HT63

Class T Fuse Adapter Kits

100-600A fusible switches are field convertible to accept Class T fuses. 400-600A switches are field convertible to accept Class T fuses by moving the load base to a pre-drilled T fuse position.

Class T Fuse Adapter Kits^③

Catalog Number	Description
HT23	100A, 240V Kit
HT63	100A, 600V Kit
HT24	200A, 240V Kit
HT64▲	200A, 600V Kit

Class J Fuse Provisions

All 30-600A, 600V fusible switches are field convertible to accept Class J fuses by moving the load base to a pre-drilled J fuse position.

Window Kits (Type 1, 12, 3R and 4x)

Allows viewing of visible blades and of indicating fuses through 200A.

Catalog Number	Description
VBWK1	30A Window Kit
VBWK2	60 & 100A Window Kit
VBWK3	200-600A Window Kit

NEW Quick Connects

They provide two point control power take-off capability and are normally used on two poles on the line side when it is required to have control power available when the switch is in the OFF position. They provide a mounting provision for standard 1/4" quick connect terminal. Installed in the line or load side. 30A VBII switches have lugs UL listed to accept (2) wires per pole as standard so a 30A kit is not required.

Catalog Number	Description
HCQ62	60A 2 wire quick connect kit
HCQ63	100A 2 wire quick connect kit
HCQ64	200A 2 wire quick connect kit



HN612

Neutral Kits^④

Standard Neutral Kits can be field installed in 30-100A switches.

Neutral Kits

Switch Ampere Rating	Kit Catalog Number
30A 600V, 60A 240V	HN612
60A, 600V & 100A	HN623

200% Neutral Kits^④

UL listed 200% Neutrals are available on 60 & 100A switches. They are typically used with non-linear transformers or where increased neutral ampacity/lug capacity is required.

200% Neutral Kits

Switch Ampere Rating	Kit Catalog Number	Wire Range Line & Load Lugs (Cu/Al)
60 & 100A	HN263	(2) #14-1/0 AWG

▲ Built to order. Allow 6-8 weeks for delivery.
 ① Dimensions (min. & max.) from enclosure mounting pan to outside surface of enclosure handle mounting flange.

② 7.12 for 200A switches.
 ③ One kit per pole required.

④ UL approved (not CSA certified).

Disconnect Switches

Type VBII (30-600A) with Flange Mounted Operating Handle

Accessories

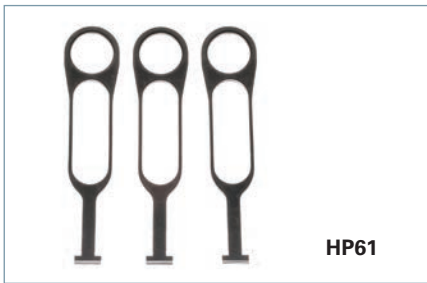

Auxiliary Contacts

The auxiliary contacts are available in 1 normally open and 1 normally closed or 2 normally open and 2 normally closed configurations. Siemens offers a PLC Auxiliary Switch (30-200A) that has very low resistance for low voltage and current typical in PLC circuits. All auxiliary contacts make after and break before main switch contacts.

Switch Ampere Rating	Aux. Switch Catalog Number	Kit Ampere Rating			Kit Horsepower Rating		
		125V AC Max.	250V AC Max.	28V DC Max.	125V AC Max.	250V AC Max.	28V DC Max.

With 1 NO & 1 NC Isolated Contacts

30-200	HA161234	10	10	—	1/2	3/4	—
400-600	HA165678	10	10	—	1/2	3/4	—

With 2 NO & 2 NC Isolated Contacts

30-200	HA261234	10	10	7	1/2	3/4	—
400-600	HA265678	10	10	7	1/2	3/4	—

Low Current PLC Type with 1 NO & 1 NC Gold Plated Contacts

30-200	HA361234	10	10	—	1/2	3/4	—
400-600	HA365678	10	10	—	1/2	3/4	—

Fuse Puller Kits

Fuse Puller Kits are field installable in 30-100A Type VBII Heavy Duty Switches (one kit required per 3-pole switch).

Switch Ampere Rating	Fuse Puller Kit Catalog Number
30	HP61
60	HP62▲
100	HP63▲

Copper Lug Kits

All switches are UL approved to accept field installed copper lug kits.

Switch Ampere Rating	Copper Lug Catalog Number	Description
30-60	HLC612	(9) Lugs/Kit #14-4 AWG Cu
100	HLC63▲	(9) Lugs/Kit #14-1/0 AWG Cu
200	HLC64▲	(9) Lugs/Kit #6 AWG-300 Kcmil Cu
400-600A	HLC65678	(1) Lugs/Kit #1/0 AWG-600 Kcmil Cu

Equipment Ground Kits

Equipment Ground Lug Kits are available for all switches.

Switch Ampere Rating	Catalog Number	Number of Terminals	Wire Range Per Terminal (Cu/Al)
30-200	HG61234	2	#14-4 AWG
400 & 600	HG656	4	#6 AWG-250 Kcmil

NEW Internal Shield Kits (for fusible switches)

Kits provide a "skirt" that encloses the VBII switch and also a clear plastic inner door to prevent accidental contact with live parts. Test probe holes are provided and fuses can be replaced without removal of kit.

Switch Ampere Rating	Shield Kit Catalog Number
30A	HSK61
60-100A	HSK623
200A	HSK64

▲ Built to order. Allow 6-8 weeks for delivery.

Disconnect Switches

Type VBII (30-600A) with Flange Mounted Operating Handle

Lug Wire Ranges & Dimensions

Lugs

30 & 60A switches are suitable for use with 60° or 75°C wire. 100–600A switches are suitable for use with 75°C rated wire. All switches are supplied with factory installed line and load lugs.

Wire Ranges (Line, Load and Standard Neutral)

Switch Ampere Rating	UL Approved Wire Range	Lug Wire Range
30	#14-6 AWG (Cu/Al)	#14-2 AWG (Cu/Al)
60	#14-2 AWG (Cu/Al)	#14-2 AWG (Cu/Al)
100	#14-1/0 AWG (Cu/Al)	#14-1/0 AWG (Cu/Al)
200	#6 AWG-300 Kcmil (Cu/Al)	#6 AWG-300 Kcmil (Cu/Al)
400	1/0 AWG-750 Kcmil (Cu/Al) or (2) 1/0 AWG-250 Kcmil (Cu/Al)	(1) 1/0 AWG-750 Kcmil (Cu/Al) or (2) 1/0 AWG-250 Kcmil (Cu/Al)
600	(2) 1/0 AWG-750 Kcmil (Cu/Al) or (4) 1/0 -250 Kcmil (Cu/Al)	(2) 1/0 AWG-750 Kcmil (Cu/Al) or (4) 1/0 AWG-250 Kcmil (Cu/Al)

Approximate Dimensions

Mounting bracket shown with handle installed is supplied with Flange Mounted Switches only. All Panel Mounted Switches have a "L" shaped mounting pan with a line base, load base (if fusible) and mechanism installed.

Catalog Number	Dimensions				
	A	B	C [ⓐ]	D (min)	D (max)
Fusible, Panel Mounted					
VBFS321	11.88	N/A	7.47	6.94	19
VBFS322	13.12	N/A	8.50	6.94	19
VBFS361, VBFS361PV	11.88	N/A	7.47	6.94	19
VBFS362, VBFS362PV	13.12	N/A	8.50	6.94	19
VBFS363, VBFS363PV	13.12	N/A	8.50	6.94	19
VBFS364	17	N/A	12.33	7.12	19
VBFS365	26.25	N/A	16.50	8.63	19
VBFS366	26.25	N/A <td 16.50	8.63	19	
Non-fusible, Panel Mounted					
VBNFS361, VBNFS361PV	9.79	N/A	7.47	6.94	19
VBNFS362, VBNFS362PV	9.79	N/A	8.50	6.94	19
VBNFS363, VBNFS363PV	9.79	N/A	8.50	6.94	19
VBNFS364	10.77	N/A	12.33	7.12	19
VBNFS365	13	N/A	16.50	8.63	19
VBNFS366	13	N/A	16.50	8.63	19
Fusible, Flange Mounted					
VBFS321F	11.88	14.08	7.47	7.27	N/A
VBFS322F	13.12	15.83	8.85	7.27	N/A
VBFS361F, VBFS361FPV	11.88	14.08	7.47	7.27	N/A
VBFS362F, VBFS362FPV	13.12	15.83	8.85	7.27	N/A
VBFS363F, VBFS363FPV	13.12	15.83	8.85	7.27	N/A
VBFS364F	17	18.20	12.68	7.57	N/A
Non-fusible, Flange Mounted					
VBNFS361F, VBNFS361FPV	9.79	11.78	7.47	7.27	N/A
VBNFS362F, VBNFS362FPV	9.79	11.78	8.85	7.27	N/A
VBNFS363F, VBNFS363FPV	9.79	11.78	8.85	7.27	N/A
VBNFS364F	10.77	11.97	12.68	7.57	N/A

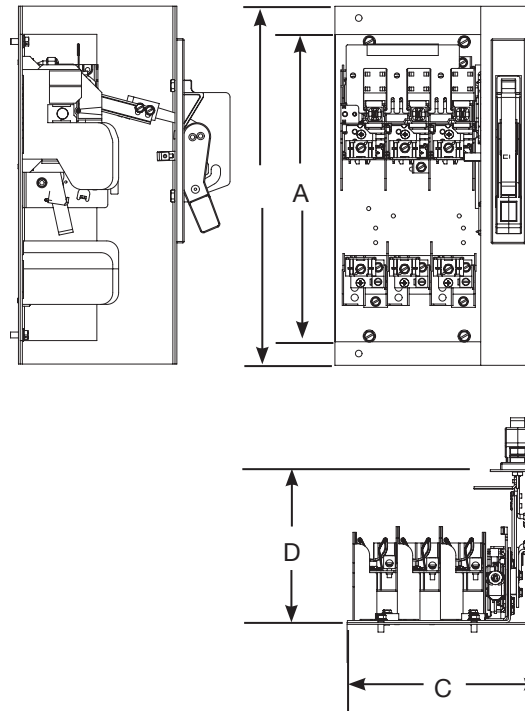

[ⓐ] Dimension C for panel mounted switches indicates the minimum width from the left hand edge of the switch mounting pan to the right hand inside surface of the enclosure.

Disconnect Switches

Type MCS (30-200A) — Switches, Fuse and No Fuse Kits

Selection

Features

- 30, 60, 100 and 200 Ampere Switches
- UL Recognized (file # E121152 vol. 1 & 2) and CSA Certified
- Simple Mounting — with an integral switch and over center mechanism
- Horsepower & load break rated
- Compact Size
- Visible Blade Contacts
- Rugged Construction — with a short circuit current rating of 10,000 amps with Class H or 200,000 amps at 600V maximum AC, when fused with Class R or Class J fuses
- Available with three operator handle options, allowing flexible placement of switch
- Field Installable Auxiliary Contacts
- Flexible Fuse Class Configurations
- Flange mounted handles meet NFPA79 requirements

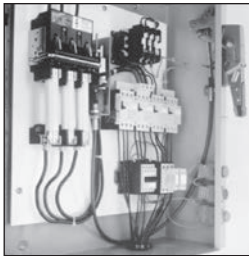

Type MCS Disconnect Switch with Max-Flex™ handle operator

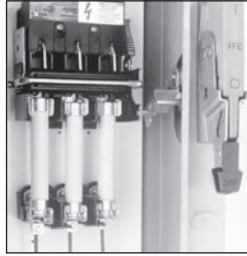

Type MCS Disconnect Switch with fixed-depth, flange-mounted handle

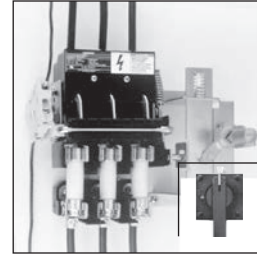

Type MCS Disconnect Switch with rotary handle

Ordering Information

- Select the basic switch size you need (30, 60, 100 or 200 ampere).
- Check the switch selected against the maximum horsepower rating required for our application. "L" or "R" suffix on switch catalog numbers denotes left or right-handed mechanism drive.
- Choose either fuse or no fuse kit from chart below.
- Check "Minimum Dimensions" on page 18/86 for installation space requirements.
- Select from the list of handle operators, the type which best suits your application. Handle operators can be selected from the next page.

Basic Switches

Switch Ampere Rating	Maximum Voltage Rating	Catalog Number Right Hand	Catalog Number Left Hand	Maximum Horsepower Rating, 3 Phase ^①						250 Volts DC (max) ^②
				240 Volts AC		480 Volts AC		600 Volts AC		
				Standard Fuse	Time Delay Fuse	Standard Fuse	Time Delay Fuse	Standard Fuse	Time Delay Fuse	
30	600	MCS603R	MCS603L	3	7½	5	15	7½	20	5
60	600	MCS606R	MCS606L	7½	15	15	30	15	50	10
100	600	MCS610R	MCS610L▲	15	30	25	60	30	75	20
200	600	MCS620R	MCS620L▲	25	60	50	125	60	150	40

Fuse And No Fuse Kits (Includes load base plus line and load fuse clips)^①

Basic Switch Ampere Rating	Switch Catalog Number	Kit Description	No Fuse Kits		For Class H	For Class J	For Class R	Lug Wire Size
			Standard	Cu Only ^②				
			Catalog Number	Catalog Number	Catalog Number ^①	Catalog Number ^①	Catalog Number ^①	
30	MCS603R or MCS603L	No Fuse	TMK606	—	—	—	—	#14 to #4 AWG Cu/Al
		30A, 250V	—	—	FCK203▲	—	—	
		30A, 600V	—	—	FCK206	FCJK603	FCRK203	
		60A, 250V	—	—	FCK206	—	FCRK206	
		60A, 600V	—	—	FCK606	FCJK606	FCRK606	
60	MCS606R or MCS606L	No Fuse	TMK606	—	—	—	—	#14 to #4 AWG Cu/Al
		60A, 250V	—	—	FCK206	—	FCRK206	
		60A, 600V	—	—	FCK606	FCJK606	FCRK606	
		100A, 250V	—	—	OFCK661▲	OFCK661▲	OFCK661▲ ^③	
		100A, 600V	—	—	OFCK661▲	OFCK661▲	OFCK661▲ ^③	
100	MCS610R or MCS610L	No Fuse	TMK610	TMK610C	—	—	—	#14 to #2/0 AWG Cu/Al
		100A, 250V	—	—	FCK610	FCK610	③	
		100A, 600V	—	—	FCK610	FCK610	③	
		200A, 250V	—	—	OFCK620	OFCK620	③	
		200A, 600V	—	—	OFCK620	OFCK620	③	
200	MCS620R or MCS620L	No Fuse	TMK620	TMK620C▲	—	—	—	#6 to 300 kcmil Cu/Al
		200A, 250V	—	—	FCK620	FCK620	③	
		200A, 600V	—	—	FCK620	FCK620	③	

▲ Built to order. Allow 6–8 weeks for delivery.

① For "copper only" connectors, order as follows:

Fusible—order standard switch, standard fuse kit and copper only no fuse kit.

Non-Fusible—order standard switch and copper only no fuse kit.

② Includes both line and load lugs.

③ For Class R fuses order Class H kit from this table and the Class R conversion kit from the next page.

④ HP ratings for time delay fuses and for 250V DC also apply to Non-fusible switches.

Disconnect Switches

Type MCS (30-200A)

Accessories

Auxiliary Switch Kits

Switch Catalog Number	Contact Arrangement	
	1 NO/1 NC Catalog Number	2 NO/2 NC Catalog Number
MCS603R	MCSAKR136	MCSAKR236
MCS603L	MCSAKL136	MCSAKL236▲
MCS606R	MCSAKR136	MCSAKR236
MCS606L	MCSAKL136	MCSAKL236▲
MCS610R	MCSAK116	MCSAK216
MCS610L	MCSAK116	MCSAK216
MCS620R	MCSAK126	MCSAK226
MCS620L	MCSAK126	MCSAK226

Class R Fuse Conversion Kits

Fuse Clip Rating	Catalog Number
100A, 600V	SSRK33
200A, 600V	SSRK34

Fuse Ejector Kits

Switch Catalog Number	Fuse Ejector Kit Catalog Number
MCS610	FE100▲
MCS620	FE200▲

Handle Operators

Fixed Depth, Flange Mounted, Types 1, 3, 3R, 12^{①④}

Switch Catalog Number	Complete Handle Mechanism	Handle Only	Switch Operator Only
	Catalog Number	Catalog Number	Catalog Number
MCS603R	FDFS06R	FDH10	FDS06R
MCS603L	FDFS06L	FDH10	FDS06L
MCS606R	FDFS06R	FDH10	FDS06R
MCS606L	FDFS06L	FDH10	FDS06L
MCS610R	FDFS06R	FDH10	FDS06R
MCS610L	FDFS06L	FDH10	FDS06L
MCS620R	FDFS20R	FDH20	FDS20R
MCS620L	FDFS20L	FDH20	FDS20L

Variable Depth, Flange Mounted Max-Flex™, Types 1, 3, 3R, 12^②

Switch Catalog Number	Complete Handle Mechanism	Handle Only	Switch Operator Only	Cable Only ^③
	Catalog Number	Catalog Number	Catalog Number	Catalog Number
MCS603R	FHOS06036R	FHOHS	FHOS06R	FHOEC036
MCS603L	FHOS06036L	FHOHS	FHOS06L	FHOEC036
MCS606R	FHOS06036R	FHOHS	FHOS06R	FHOEC036
MCS606L	FHOS06036L	FHOHS	FHOS06L	FHOEC036
MCS610R	FHOS06036R	FHOHS	FHOS06R	FHOEC036
MCS610L	FHOS06036L	FHOHS	FHOS06L	FHOEC036
MCS620R	FHOS20036R	FHOHS	FHOS20R	FHOJC036
MCS620L	FHOS20036L	FHOHS	FHOS20L	FHOJC036

Variable Depth Rotary, Through-The-Door-Mounted, Types 1, 12^{④⑤}

Variable Depth				Shaft Only Variable Depth
MCS603R	CRHOS06VD	CRHOH	RHOS06	RHOSVD
MCS606R	CRHOS06VD	CRHOH	RHOS06	RHOSVD
MCS610R	CRHOS06VD	CRHOH	RHOS06	RHOSVD
MCS620R	CRHOS20VD	RHOH	RHOS20	RHOSVD

MCS Disconnect Switch Panel Space Requirements

Panel Space Requirements

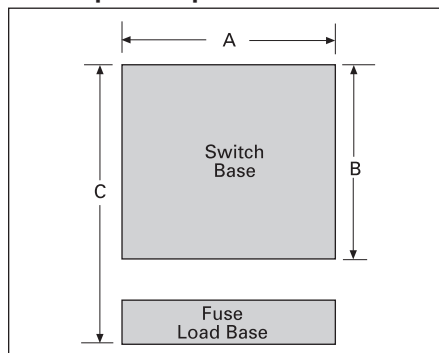

Minimum Dimensions (inches*)

Switch Catalog Number	Size	"A"	"B"	"C"	Fuse Class
MCS603	30A/240V	6.13	5.52	8.11	H, K, R
	30A/600V	6.13	5.52	10.11	H, K, R
	30A/600V	6.13	5.52	8.48	J
MCS606	60A/240V	6.13	5.52	7.86	H, K, R
	60A/600V	6.13	5.52	10.38	H, K, R
	60A/600V	6.13	5.52	8.35	J
MCS610	100A/240V	7.38	7.59	11.85	H, K, R
	100A/600V	7.38	7.59	13.85	H, K, R
	100A/600V	7.38	7.59	10.6	J
MCS620	200A/240V	9.17	9.00	14.7	H, K, R
	200A/600V	9.17	9.00	17.2	H, K, R
	200A/600V	9.17	9.00	13.32	J

"A" – Dimension is measured from each cross bail pin.

"B" – Dimension is measured from line side barrier to load side barrier.

"C" – Dimension is measured from line side terminal of switch to load side terminal of fuse load base.

▲ Built to order. Allow 6-8 weeks for delivery.
 ① For Type 4 and 4X applications, order handle only Catalog Number 100A - FDH104 200A - FDH204
 ② For Type 4 and 4X applications, order handle only Catalog Number FHOHS4

③ Standard cable length is 36 inches. Alternate lengths are available as follows:

Length	Amps	Cat. No.
48"	30-100	FHOEC048
60"	30-100	FHOEC060
48"	200	FHOJC048
60"	200	FHOJC060

④ For Type 4 and 4X applications, order handle only Catalog Number RHOSH4
 ⑤ For Type 3 and 3R applications, order handle only Catalog Number RHOH
 ⑥ Min. enclosure depth from mounting pan to handle mounting surfaces: 30-100A 6.44 inches
 200A 10.93 inches
 *For millimeters multiply inches by 25.4.

Type CFS Compact Fusible Switches

Description

Siemens Type CFS compact fusible switches meet UL 98 requirements and can be used in either service entrance or branch circuit applications. 30-800A, 3 pole switches are offered and are all rated 600V AC maximum. 30A switches are available with provisions for either Class CC or J fuses. 60A and larger switches provided with Class J fuse provisions can be used in non-fusible applications with field installable no-fuse kits.

All are open style, designed to be panel mounted and are UL listed under file number #E121152 or #E68312 and CSA certified under file number #222227. A variety of door mounted rotary operators are available with Type 1, 3R, 12 or 4/4X ratings.

NFPA79 Kits

CFSNFPA1 AND CFSNFPA2N kits provide an internal handle and padlocking means to comply with article 5.3.4.2 of the NFPA-2002 standard.



Catalog Numbering System

CFS Switches

Compact Fusible Switch

CFS 3 6 1 J 5 N

- Number of poles 3 = 3
- Max. Voltage Rating 6 = 600V
- Ampere rating
 - 1 = 30A
 - 2 = 60A
 - 3 = 100A
 - 4 = 200A
 - 5 = 400A
 - 6 = 600A
 - 7 = 800A
- Fuse provisions type
 - C = Class CC
 - J = Class J with right hand mechanism
 - JL = Class J with left hand mechanism
 - L = Class L with right hand mechanism
- Max. AIC rating
 - 5 = 100kA
 - Omit = 200kA J fused
- Version
 - N = New size reduced version
 - N1 = New 100kA 60A switch

Operating Handles

CFS type handle

CFSH 10 R 12 N

- Shaft cross section
 - 5 = 5 mm
 - 10 = 10 mm
 - 12 = 12 mm
- Handle color and length
 - B = Black & blue, short
 - R = Red & yellow, short
 - BL = Black & blue, long
 - RL = Red & yellow, long
- NEMA type
 - 12 = 1, 3R and 12
 - 4 = 1, 3R, 12 and 4/4X
- Version
 - N = New version

CFS Operating Shafts

CFS type shaft

CFSS 10 200 H N

- Shaft cross section
 - 5 = 5 mm
 - 10 = 10 mm
 - 12 = 12 mm
- Shaft length
 - 200 = 200 mm
 - 400 = 400 mm
- Switch compatibility
 - Omit = 30A, 100kA
 - H = 100 or 200 kA
- Version
 - N = New version

Disconnect Switches

Type CFS Compact Fusible Switches

Features and Ordering Information

Features

- 30 - 800A ratings
- UL Listed under file #E121152 & CSA Certified under file #222227
- Door mounted rotary handles with defeatable cover interlock
- Meets UL requirements for both main and branch circuit applications
- Compact size
- 100kA with Class CC fuses or up to 200kA with Class J fuses
- Load break and horsepower rated
- Quick make and break operation
- All handles are padlockable with up to (3) padlocks with 5/16" hasps in the OFF position
- Catalog numbers CFS361C5 & CFS361J5 can be DIN-rail mounted and can be either front or side operated with standard rotary handles..
- All CFS part numbers ending in N can be either front or side operated with standard rotary handles.
- Handles are available in Type 1, 3R, 4/4X & 12 ratings
- NFPA 79 field installed kits are available
- 30-400A, 200kA switches are provided with quick connect terminal provisions for voltage sensing or for 10A max. control circuits



Ordering information

1. Select the panel mounted switch required based on Ampere, HP and AIC requirements. Switches with a right hand mechanism are standard, 30-100A switches with a left hand mechanism are available.
2. Select handle based on environmental rating required.
3. Select operating shaft (200 or 400mm in length). For enclosure depths of 9.0" or less from panel mounting surface to inside of door use 200mm long shafts. For deeper enclosures use 400mm long shafts. 30A 100kA switches can be used in 10" deep enclosures (panel to inside of door) with 200mm shaft and CFSH5N handles.
4. Line & load lugs are provided as standard on 30-100A switches. Terminal kits are available for 200-800A switches if needed.
5. Auxiliary contact are available if needed as follows. 30A switch CFS361J5 will accept up to (2) aux contacts without an aux contact holder. If more than (2) aux contacts are required order aux contacts PLUS aux contact holder kit CFSAuxH1. All other switches will accept up to (4) aux contacts.
6. 30-100A switches are designed to prevent inadvertent contact with live parts and shields are not required. 200 & 400A switches are not supplied with terminal shields. They are available as field installed kits for both line and load terminals. 400-800A switches are supplied as standard with line shields and terminal shroud kits are available for the load side.

Note: Be sure to check shaft and handle compatibility with the switch selected by using information provided in the selection tables.

Type CFS Compact Fusible Switches

Shaft and Handle Selection

Fusible switches, 3-pole 600V AC Max. 30-100A & 600-800A switches are also rated 250V DC Max when poles are field connected in series^⑤

Switch Ampere Rating	Catalog Number	Fuse Provisions Provided	Max Horsepower Ratings				AC Short Circuit Rating
			240V 3Ø AC	480V 3Ø AC	600V 3Ø AC	250V DC	

Standard – With Right Hand Mounted Mechanism

30 ^①	CFS361C5	Class CC	7.5	15	20	5 ^③	100kA
30 ^①	CFS361J5	Class J	7.5	15	20	5 ^③	
30 ^①	CFS361JN	Class J	7.5	15	20	5 ^③	
60 ^①	CFS362JN1	Class J	15	30	50	10 ^③	100kA
60 ^①	CFS362JN	Class J	15	30	50	10 ^③	200kA
100 ^①	CFS363JN		30	60	75	20 ^③	
200 ^②	CFS364JN ^④		60	125	150	—	
400 ^②	CFS365JN ^④		125	250	350	—	
600 ^②	CFS366J ^{③⑤}		200	400	500	—	
800 ^②	CFS367L ^{③⑤}	Class L	200	400	500	—	200kA

Optional – With Left Hand Mounted Mechanism^④

30 ^①	CFS361JLN	Class J	7.5	15	20	5 ^③	200kA
60 ^①	CFS362JLN		15	30	50	10 ^③	
100 ^①	CFS363JLN		30	60	75	20 ^③	

Operating Shafts for 30-400A Switches^⑤

Catalog number	Shaft length in. (mm)	Switch & handle compatibility
CFSS5200N CFSS5400N	7.9 (200) 15.7 (400)	5mm x 5mm for use with CFS361C5 & CFS361J5 switches & with "CFSH5" handles only
CFSS5200HN CFSS5400HN	7.9 (200) 15.7 (400)	5mm x 5mm for use with all "CFSH10" handles & with CFS361C5 & CFS361J5 switches only
CFSS10200HN CFSS10400HN	7.9 (200) 15.7 (400)	10mm x 10mm for use with all "CFSH10" handles & with all 30-400A switches except CFS361C5 & CFS361J5

Compact rotary operating handles — door mounted (for use with CFS361C5 & CFS361J5 switches only)^⑤

Catalog number	Color	UL Type	Operating shaft compatibility
CFSH5B12N CFSH5R12N	Blue & Black Yellow & Red	1, 3R & 12	CFSS5200N or CFSS5400N
CFSH5B4N CFSH5R4N	Blue & Black Yellow & Red	1, 3R, 12 & 4/4X	

Rotary Operating Handles - Door Mounted

(for use with CFSS5200HN, CFSS5400HN, CFSS10200HN & CFSS10400HN)

Catalog number	Color	Description
----------------	-------	-------------

Type 1, 3R & 12^⑦

CFSH10B12N	Blue & Black	Heavy duty pistol grip (2.75" long for use with 30A switches & CFS362JN1)
CFSH10R12N	Yellow & Red	
CFSH10BL12N	Blue & Black	Heavy duty pistol grip (4.92" long for 30-400A switches)
CFSH10RL12N	Yellow & Red	

Type 1, 3R, 4/4X & 12^⑦

CFSH10B4N	Blue & Black	Heavy duty pistol grip (2.75" long for use with 30A switches & CFS362JN1)
CFSH10R4N	Yellow & Red	
CFSH10BL4N	Blue & Black	Heavy duty pistol grip (4.92" long for 30-400A switches)
CFSH10RL4N	Yellow & Red	



① Line and load lugs included.

② Line and load lugs are not included.

Order from table on next page if required.

③ DC HP rating shown requires (3) poles to be connected in series.

④ CFS364JN & CFS365JN can be rotated 180° for left hand operation as standard.

⑤ Catalog numbers CFS361C5 & CFS361J5 accept 5mm x 5mm operating shafts. All other 30-400A switches accept 10mm x 10mm operating shafts.

⑥ Compact pistol grip design (2.75" long) with defeatable cover interlock. Cover can be opened when handle is padlocked in the OFF position.

⑦ Defeatable cover interlock provided. Cover cannot be opened when handle is padlocked in the OFF position.

⑧ 4 pole 600 & 800A switches, CFS466J & CFS467L are also available.

⑨ CFS366J and CFS367L are rated 250 & 600V DC when (2) poles are connected in series.

Disconnect Switches

Type CFS Compact Fusible Switches

Selection and Accessories

600 & 800A Rotary Operating Handles - Door Mounted (8.27" long)^②

Catalog number	Color	UL Type
CFSH12BL12	Blue & Black	1, 3R & 12
CFSH12RL12	Yellow & Red	1, 3R & 12
CFSH12BL4	Blue & Black	1, 3R, 12 & 4/4X
CFSH12RL4	Yellow & Red	1, 3R, 12 & 4/4X

600 & 800A Operating Shafts (Cross Section 12mm x 12mm)

Catalog number	Shaft length in. (mm)	Enclosure depth (switch mounting surface to door OD)
CFSS12200H	12.59 (320)	10.43 – 16.68 in.
CFSS12400H	15.75 (400)	10.43 – 19.84 in.

Type CFS Fusible Switch Accessories

Catalog number	Description
----------------	-------------

Terminals^①

CFSL200	200A lug kit (6 lugs per kit) #6-3/0
CFSL400N	400A lug kit (6 lugs per kit) #2-600kcmil (for CFS365JN only)
CNFSL400D	400A lug kit (6 lugs per kit, 2 wires per lug) #6-350kcmil
CFSL400	600-800A lug kit (6 lugs per kit, 2 wires per lug) #2-600kcmil ^②

Shorting bars (no fuse kits)

CFSSB60	60A shorting bar kit (3 links per kit)
CFSSB100	100A shorting bar kit (3 links per kit)
CFSSB200	200A shorting bar kit (3 links per kit)
CFSSB400	400A shorting bar kit (3 links per kit)
CFSSB680	600 & 800A shorting bar kit (1 link per kit)

Auxiliary contacts (NEMA ratings AC A600 DC N600)

CFSAUXH1 ^③	Aux contact holder (CFS361C5 & CFS361J5)
CFSAUX1NO	Aux contact 1 NO (30-800A Sws)
CFSAUX1NC	Aux contact 1 NC (30-800A Sws)
CFS11AUX	1NO, 1NC aux contact kit (side mount for 200kA switches)
CFS22AUX	2NO, 2NC aux contact kit (side mount for 200kA switches)

Terminal shrouds (line or load)

CFSTS200N ^④	200A shroud kit (line or load 3-pole kit)
CFSTS400N ^④	400A shroud kit (line or load 3-pole kit for CFS365JN only)
CFSTS680 ^④	600/800A 3-pole shroud kit
CFSTS6804 ^④	600/800A 4-pole shroud kit

30A compact switch kits

CFSPK	Shaft padlocking kit for 30A compact switch when door is open
CFSH5CDM	Direct mount handle kit for CFS361C5
CFSH5JDM	Direct mount handle kit for CFS361J5

NFPA 79 kits (if auxiliary contacts are needed, see table above)

Kits provide an operating shaft suitable for use with all heavy duty handles (not for use with CFSH5 handles). Kits also provide an internal operating handle and an internal OFF padlocking provision.

CFSNFPA1 ^④	For use with CFS361C5 & CFS361J5
CFSNFPA2N ^⑤	For use with CFS361JN, CFS361CN, CFS362JN1, CFS362JN, CFS363JN & CFS364JN
CFSNFPA3N ^⑤	For use with CFS365JN only



CFSL200 & 400



CFSAUX1NC



CFSSB100 - CFSSB400

① Supplied as standard on 30-100A switches
 ② CFS361C5 will accept (4) aux contacts without an aux contact holder. CFS361J5 will accept (2) aux contacts without an aux contact holder.
 ③ Supplied as standard on all but 30A, 100kA compact switches.

④ 12.6 in. (320 mm) long operating shaft included
 ⑤ 12.7 in. (323 mm) long operating shaft included
 ⑥ Line side terminal shrouds supplied with switch
 ⑦ Defeatable cover interlock included.
 Cover cannot be opened when the handle is padlocked in the OFF position.

⑧ Neither line or load terminal shrouds are supplied as standard with new style 200 & 400A switches.
 ⑨ 2 kits needed for 800A, total 12 lugs to cover line and load sides

UL & CSA Technical Characteristics And Panel Space Requirements

Catalog Number	Amps	Fuse Class	Ac Short Circuit Rating	Electrical Endurance	Mechanical Endurance	Panel Space Requirements - in. (mm)		
						Height	Width	Depth ^①
CFS361C5	30	CC	100kA	6000	10000	4.56 (116)	3.78 (96)	6.00 (152)
CFS361J5	30	J	100kA	6000	10000	4.56 (116)	4.15 (105)	6.00 (152)
CFS361JN	30	J	200kA	6000	10000	5.35 (136)	5.89 (150)	6.00 (152)
CFS361JLN	30	J	200kA	6000	10000	5.35 (136)	5.89 (150)	6.00 (152)
CFS362JN1	60	J	100kA	6000	10000	5.35 (136)	5.89 (150)	6.00 (152)
CFS362JN	60	J	200kA	6000	10000	7.32 (186)	5.89 (150)	6.00 (152)
CFS362JLN	60	J	200kA	6000	10000	7.32 (186)	5.89 (150)	6.00 (152)
CFS363JN	100	J	200kA	6000	10000	7.32 (186)	5.89 (150)	6.00 (152)
CFS363JLN	100	J	200kA	6000	10000	7.32 (186)	5.89 (150)	6.00 (152)
CFS364JN	200	J	200kA	6000	8000	11.46 (291)	7.72 (196)	6.00 (152)
CFS365JN	400	J	200kA	1000	6000	15.35 (390)	10.19 (259)	8.00 (203)
CFS366J	600	J	200kA	1000	5000	11.81 (300)	14.33 (364)	11.00 (280)
CFS466J	600	J	200kA	1000	5000	11.81 (300)	18.03 (458)	11.00 (280)
CFS367L	800	L	200kA	500	3500	11.81 (300)	14.33 (364)	11.00 (280)
CFS467L	800	L	200kA	500	3500	11.81 (300)	18.03 (458)	11.00 (280)

Wire Ranges Line & Load Lugs

Switch	Amperage Rating	UL Approved Wire Size (75° C)
CFS361J5	30	(1)#14-10
CFS361C5	30	(1)#14-10
CFS361JN	30	(1)#14-6
CFS362JN1	60	(1)#14-6
CFS362JN	60	(1)#12-1
CFS363JN	100	(1)#12-1
CFS364JN	200	(1)#3/0
CFS365JN	400	(1)600MCM
CFS366J	600	(2)350 MCM
CFS367L	800	(2)600 MCM

Auxiliary Contact Capability When An NFPA79 Kit Is Used

Switch	NFPA79 Kit	Aux Contacts That Can Be Installed
CFS361C5	CFSNFPA1	(2) Total, CFS AUX1NO or CFS AUX1NC
CFS361J5		(1) CFS AUX1NO or (1) CFS AUX1NC
CFS361JN	CFSNFPA2N	(2) Total, CFS AUX1NO or CFS AUX1NC ^②
CFS362JN1		
CFS362JN		
CFS363JN		
CFS364JN	CFSNFPA3N	(2) Total, CFS AUX1NO or CFS AUX1NC ^②
CFS365JN		

① Minimum dimensions from mounting surface to inside of cover. Dimensions shown can be decreased if aux contacts are not required.

② For additional auxiliary contacts use side mounted CFS11AUX or CFS22AUX.

Disconnect Switches

Type CNFS Compact Non-Fusible Switches

General Information

Type CNFS Compact Non-Fusible Switches

Description

Siemens Type CNFS compact non-fusible switches meet UL 98 requirements and can be used in either service entrance or branch circuit applications. They are available in 30-800A, 3-pole switches and are all rated 600VAC maximum.

All are open style, designed to be panel mounted and are UL listed under file number #E121152 or #E68312 and CSA certified under file number #222227. A variety of door mounted rotary operators are available with Type 1, 3R, 12 or 4/4X ratings.

These non-fusible switches are UL listed under file #E201138 and CSA certified under file #112964. They also conform to IEC standard 60947-3.

Catalog Numbering System

CNFS Switches

Compact Non-Fusible Switch

- | | | | | |
|------|---|---|---|---|
| CNFS | 3 | 6 | 1 | N |
|------|---|---|---|---|
- Number of poles 3 = 3
 - Max. Voltage Rating 6 = 600V
 - Ampere rating
 - 1 = 30A
 - 2 = 60A
 - 3 = 100A
 - 4 = 200A
 - 5 = 400A
 - 6 = 600A
 - 7 = 800A
 - Design type
 - N = Compact design



Disconnect Switches

Type CNFS Compact Non-Fusible Switches

Features And Ordering Information

Features

- 30 - 800A ratings
- UL Listed under file #E201138 & CSA Certified under file #112964 or #703166
- Options to have door mounted pistol handles with defeat-able cover interlock or direct mounted handles.
- Meets UL 98 requirements
- Compact size
- All short circuit protection ratings require the use of Class J fuses in the circuit.
- Load break and horsepower rated
- Quick make and break operation
- All external handles and direct handles for 600-800A switches are padlockable with up to (3) padlocks with 5/16" hasps in the OFF position. Direct handles for 30-100A switches are padlockable with (1) padlock with 3/16" hasps in the OFF position.
- All switches are able to be panel mounted. Catalog numbers CNFS361N, CNFS362N, & CNFS363N can also be DIN-rail mounted and can either be front or side operated with standard pistol handles.
- Handles are available in Type 1, 3R, 4/4X & 12 ratings



Ordering information

1. Select the panel mounted switch required based on Ampere, HP and AIC requirements. Switches with a right hand mechanism are standard.
 2. Select handle based on environmental rating required.
 3. For door mounted handles, select operating shaft based on enclosure depth. For enclosure depths of 9.00" or less from panel mounting surface to inside of door use up to 200 mm long shafts. From 9.00" to 13.00" use up to 320 mm long shafts. For deeper enclosures use up to 400 mm long shafts. For direct mount handles, no shaft is needed.
 4. Line & load lugs are provided as standard on 30-100A switches. Terminal kits are available for 200-800A switches if needed.
 5. Auxiliary contacts are available if needed. Each switch will accept up to (2) aux contact modules, containing (2) contacts in each.
 6. 30-100A Series N switches are designed to prevent inadvertent contact with live parts and shields are not required but are offered as terminal shrouds. 100-400A switches are not supplied with terminal shields. They are available as separate field installed kits for both line and load terminals by amperage rating. Line side terminal screens are provided for 600-800A switches.
- Note: Be sure to check shaft and handle compatibility with the switch selected by using information provided in the selection tables.

Disconnect Switches

Type CNFS Compact Non-Fusible Switches

Shaft and Handle Selection

Type CNFS compact non-fusible switches

Switch Ampere Rating	Catalog Number	Max Horsepower Ratings			Short Circuit Rating	
		240V 3Ø AC	480V 3Ø AC	600V 3Ø AC	@ 480VAC	@ 600VAC
30	CNFS361N ^①	10	20	25	100	100
60	CNFS362N ^①	20	40	50	100	100
100	CNFS363N ^①	20	50	50	100	25
200	CNFS364N ^②	75	150	200	200	200
400	CNFS365N ^②	125	250	350	200	200
600	CNFS366N ^②	200	400	350	200	200
800	CNFS367N ^②	200	500	500	100	100



Direct mount rotary handles for compact non-fusible switches

Catalog Number	Color	Use with compact non-fusible switches
CNFSHD1	Blue	CNFS361N, CNFS362N, CNFS363N
CNFSHD2	Black	CNFS364N, CNFS365N
CNFSHD3	Black	CNFS366N, CNFS367N



Operating shafts for compact non-fusible switches

Catalog Number	Shaft length in. (mm)	Switch and handle compatibility
CNFSS52001	7.9 (200)	5mm x 5mm for use with CNFS361N, CNFS362N and CNFS363N switches and with "CNFSH5" handles only
CNFSS53201	12.6 (320)	
CNFSS54001	15.7 (400)	
CFSS10200HN	7.9 (200)	10mm x 10mm for use with "CFSH10" handles and with CNFS364N and CNFS365N switches only
CNFSS103202	12.6 (320)	
CFSS10400HN	15.7 (400)	
CNFSS152003	7.9 (200)	15mm x 15mm for use with "CFSH12" handles and with CNFS366N and CNFS367N switches only
CNFSS153203	12.6 (320)	
CNFSS154003	15.7 (400)	



Compact rotary operating handles for non-fusible switches – door mounted

Catalog Number	Color	UL Type	Operating shaft compatibility	Use with non-fusible compact switches
CNFSS5BP121	Black	NEMA 1, 3R, 12	CNFSS52001, CNFSS53201, CNFSS54001	CNFS361N, CNFS362N, CNFS363N
CNFSS5RP121	Red/Yellow	NEMA 1, 3R, 12		
CNFSS5BP41	Black	NEMA 4/4X		
CNFSS5RP41	Red/Yellow	NEMA 4/4X		
CFSS10BL12N	Black	NEMA 1, 3R, 12	CFSS10200HN, CNFSS103202, CFSS10400HN	CNFS364N, CNFS365N
CFSS10RL12N	Red/Yellow	NEMA 1, 3R, 12		
CFSS10BL4N	Black	NEMA 4/4X		
CFSS10RL4N	Red/Yellow	NEMA 4/4X		
CFSH12BL12	Black	NEMA 1, 3R, 12	CNFSS152003, CNFSS153203, CNFSS154003	CNFS366N, CNFS367N
CFSH12RL12	Red/Yellow	NEMA 1, 3R, 12		
CFSH12BL4	Black	NEMA 4/4X		
CFSH12RL4	Red/Yellow	NEMA 4/4X		

① Line and load lugs are included.

② Line and load lugs are not included. Order from table on following pages if needed.

③ All switches can be rotated 180° for left hand operation as standard.

④ Flange mounting is not available for non-fusible switches.

Disconnect Switches

Type CNFS Compact Non-Fusible Switches

Additional Accessories

Auxiliary contacts for use with non-fusible switches

Catalog Number	Number of Contacts	Use with Non-fusible Contact Switches
CNFS1AUX1	1 Normally Open + 1 Normally Closed	CNFS361N, CNFS362N, CNFS363N
CNFS2AUX1	2 Normally Closed	
CNFS1AUX2	1st Auxiliary Contact: 1 Normally Open + 1 Normally Closed	CNFS364N, CNFS365N, CNFS366N, CNFS367N
CNFS2AUX2	2nd Auxiliary Contact: 1 Normally Open + 1 Normally Closed	



Terminal shrouds for use with non-fusible switches

Catalog Number	Shroud Location	Use with Non-fusible Contact Switches
CNFSSTS100	Top and Bottom	CNFS361N, CNFS362N, CNFS363N
CNFTSC200T	Top	CNFS364N
CNFTSC200B	Bottom	
CNFTSC400T	Top	CNFS365N
CNFTSC400B	Bottom	
CNFTSC600B	Bottom	CNFS366N
CNFTSC800B	Bottom	CNFS367N



Terminal lug kits for use with non-fusible switches

Catalog Number	Wire Sizes	Use with Non-fusible Contact Switches
Included	#10-2/0	CNFS361N, CNFS362N, CNFS363N
CFSL200	#6-300MCM	CNFS364N
CFSL400N	#2-600MCM	CNFS365N
CNFSL400D	#6-350MCM, 2 wires per lug	CNFS366N
CFSL400	#6-350MCM, 2 wires per lug	CNFS366N, CNFS367N ^①



① 2 kits needed for 800A, total 12 lugs to cover line and load sides.

