

— optipro™ —

MCBs and Distribution Boards



INDOASIAN ™
MAKES SENSE



Complete Solutions

IndoAsian with its Indian origin and strong presence has garnered longstanding trust amongst its consumers over the past 56 years. IndoAsian's high quality products and their unmatched value are a result of Frugal Engineering that caters especially to the Indian market.

Today we present to you, the complete Optipro range – the reliable choice in protection and distribution devices. Optipro's flexible range includes the best quality MCBs and Distribution Boards that are priced just right, and it is all that you need. Coming from the company that has expertise in catering to this product segment, it makes sense to choose Optipro for your dream project.

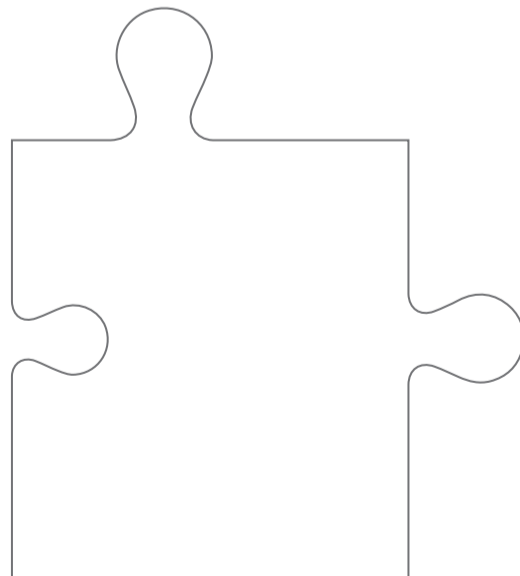
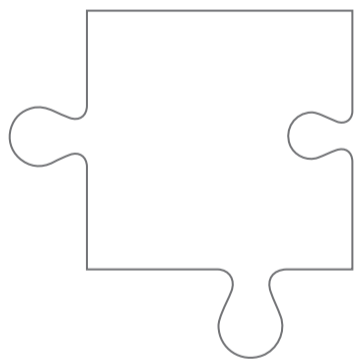



The Range

Optipro is the result of a clear understanding of consumer needs.

The extensive range, which includes MCBs, Isolators, RCDs, Distribution Boards and Accessories, takes care of all your project requirements. They are designed to provide complete protection against short-circuits, overloads and residual current faults, and come with a wide range of phase selectors, enclosures, and plug and socket types, thus making Optipro a safe and reliable choice for your projects.

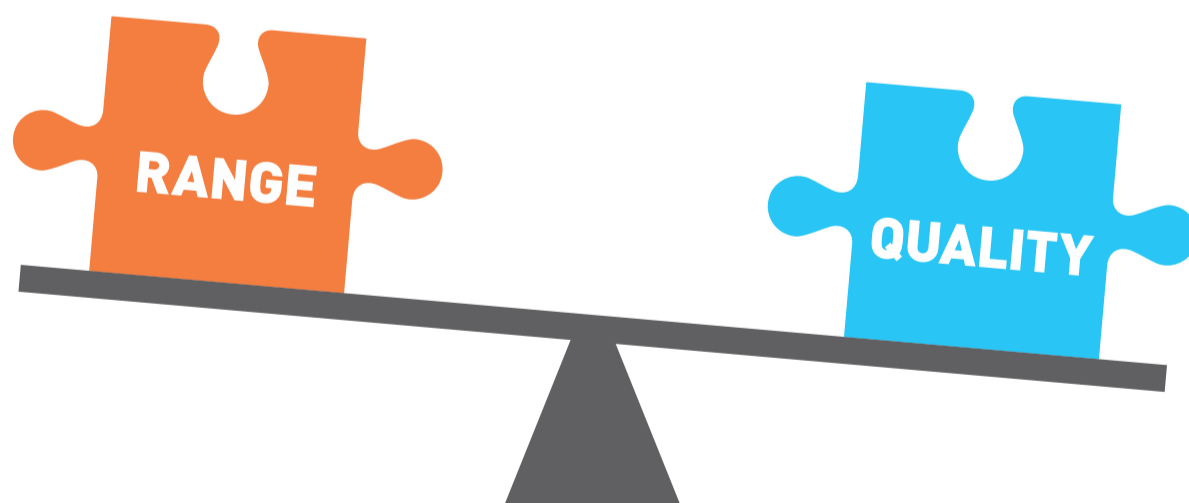

The Quality

Optipro is developed through an engineering process that reduces complexity in production but, at the same time, promises uncompromising quality. The homogeneity of these products is evident in their firm finishes. The technical identifications on the products withstand the test of time, thanks to high quality pad printing. The carefully selected components that make up the Optipro range are resistant to extreme weather conditions and thus ensure durability and great performance.



The Right Deal

IndoAsian has stayed true to its brand promise of true value. Optipro doesn't just promise a comprehensive range of great quality, but offers it at the right deal, making it 'All That You Need'.



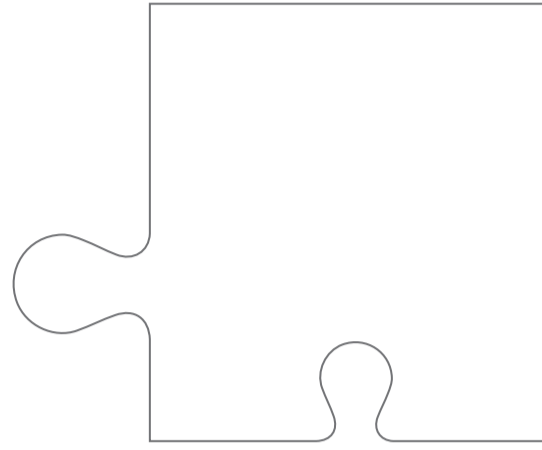

MCBs

Optipro's range of MCBs demonstrates proven endurance against overloads and short circuits with its high current-carrying capacity. Engineered to support easy installation, each MCB is designed keeping in mind the highest safety and compliance parameters. This means zero exposure to live parts, and a user-friendly, efficient interface that makes Optipro the only safe and reliable choice.

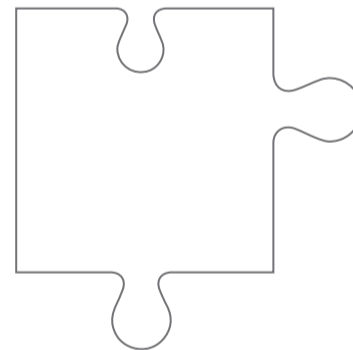
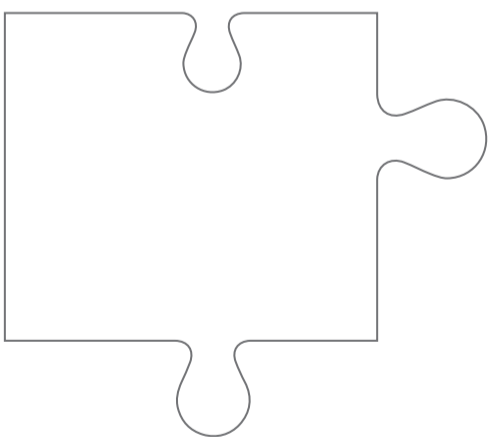

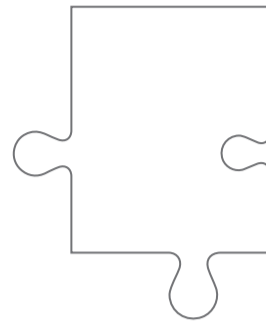

Features

Complete Range

The complete Optipro range includes MCBs, Isolators, RCDs, and Accessories.



Exceptional Endurance

The products have high electrical and mechanical endurance, with ambient temperatures of -25°C to $+70^{\circ}\text{C}$.

Breaking Capacity

The devices in the range have a breaking capacity of 10kA.

Line Load Reversibility

The design enables line load reversibility in MCBs which means that you can connect the load from either side (top or bottom) of the MCB.





Contact Indication Window

The devices are designed as per user friendliness.

The visual indications help users identify the position of the MCB.

- Red = ON • Green = OFF

Large Terminal

The 35 sq mm terminal is designed to incorporate wires of bigger sizes. It ensures safety by making sure that the loose ends of the wires are tightly held and don't hang around.



Protection IP 20

We realise the importance of safety, and have designed the range in such a way that no live parts are exposed to human contact, thus making the devices safe to use.



Dual Position Clamp

The dual position clamp helps in easy mounting and unmounting of the MCB.

Superior Design

Optipro's homogenous design is aesthetically superior and built in with features like the ergonomically designed knob for better grip and good quality pad printing.





Air Flow Channel

The special air flow channel on the MCBs allows the air to come out. This, in turn, helps in maintaining the temperature inside and thereby increases its durability.



Bi-Connect Terminal

The bi-connect terminal provides flexibility by allowing the lines to be connected through both wires and bus bars.



Power Loss per Pole (Watts)

Circuit breakers B and C curves									
Rated Current	6 A SP	10 A SP	16 A SP	20 A SP	25 A SP	32 A SP	40 A SP	50 A SP	63 A SP
Optipro	0.9	1.9	2.2	3.0	3.7	3.9	4.0	4.6	5.5
As per IS/IEC 60898-1	3	3	3.5	4.5	4.5	6	7.5	9	13

De-rating of circuit-breakers:

Ambient Temperature / In (in A)										
In (A)	- 25 °C	- 10°C	0°C	10°C	20°C	30°C	40°C	50°C	60°C	70°C
6	7.5	7	6.6	6.4	6.18	6	5.8	5.6	5.4	5.2
10	12.5	11.5	11.1	10.7	10.3	10	9.7	9.3	9	8.7
16	20	18.7	18	17.3	16.6	16	15.4	14.7	14.1	13.5
20	25	23.2	22.4	21.6	20.8	20	19.2	18.4	17.6	16.8
25	31.5	29.5	28.3	27.2	26	25	24	22.7	21.7	20.7
32	41	37.8	36.5	34.9	33.3	32	30.7	29.1	27.8	26.5
40	51	48	46	44	42	40	38	36	34	32
50	64	60	57.5	55	52.5	50	47.5	45	42.5	40
63	80.6	75.6	72.5	69.9	66.1	63	59.8	56.1	52.9	50.4

Reference temperature: 30°C according to standard IS / IEC 60898-1

Technical Characteristics - MCB

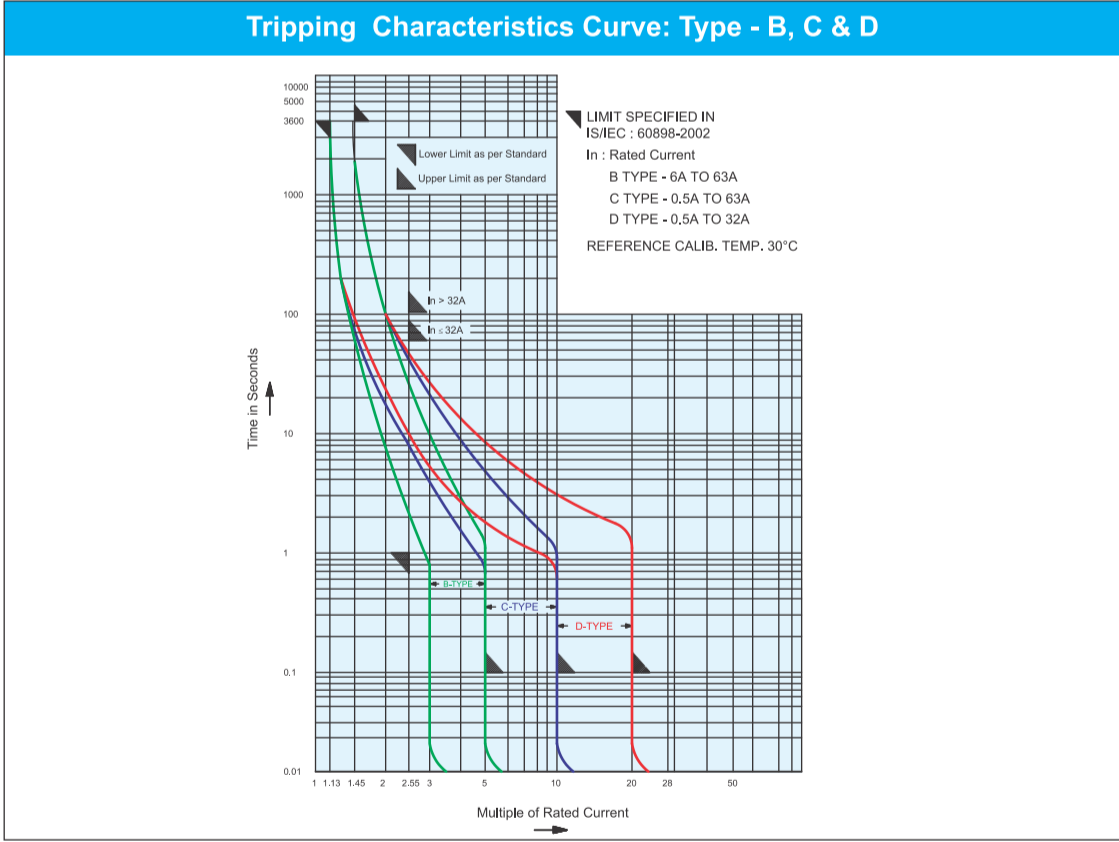
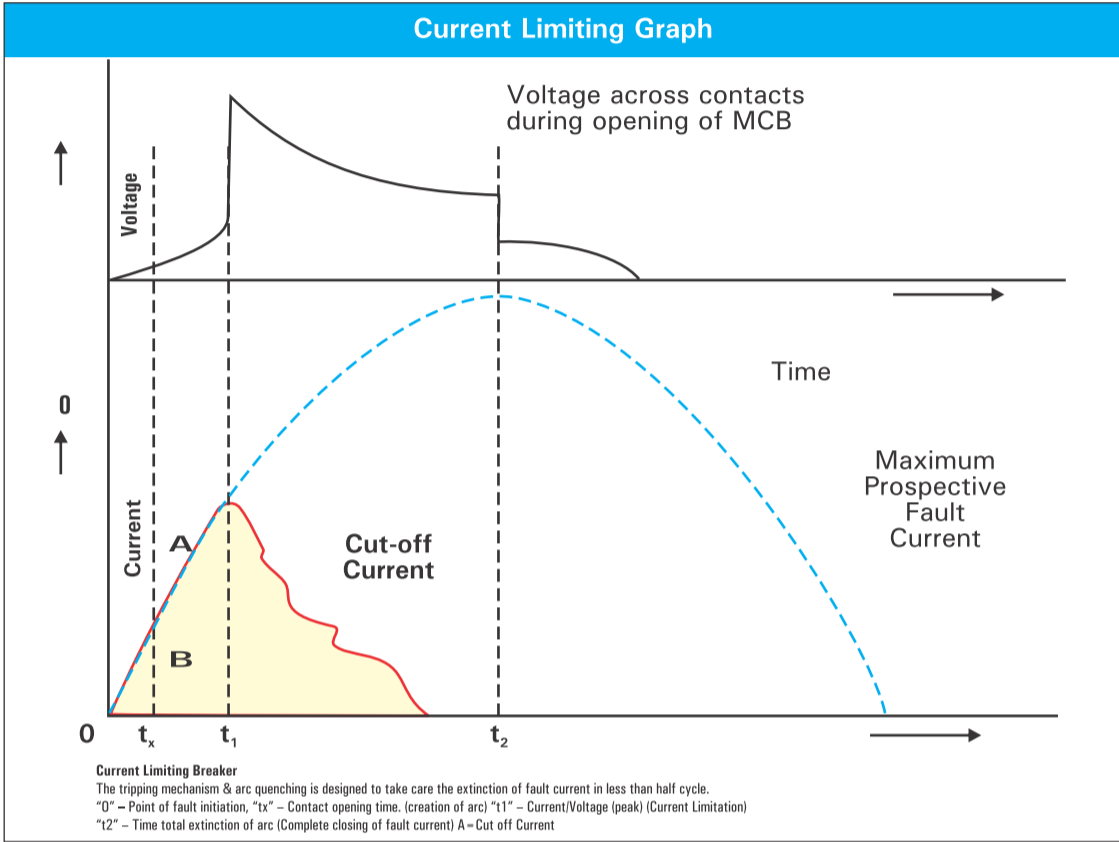

Technical Characteristics - RCCB

Tripping Characteristics Curve

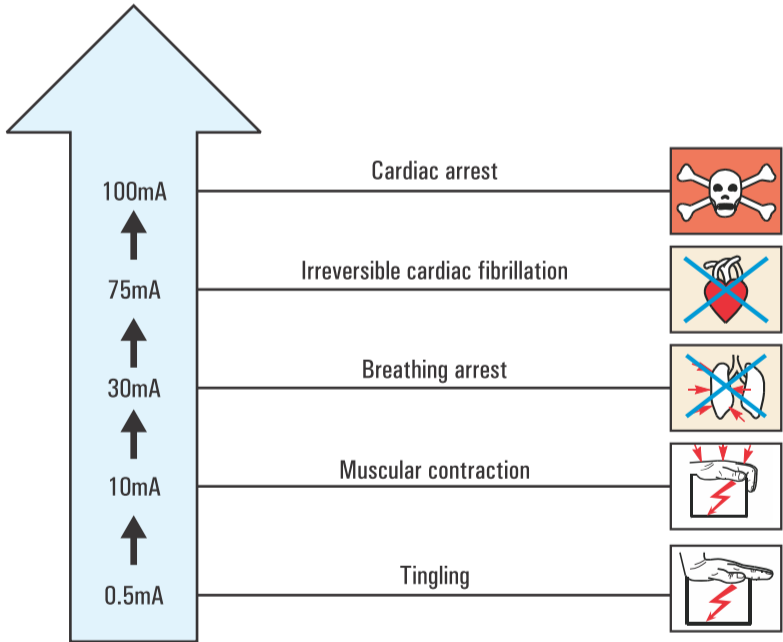
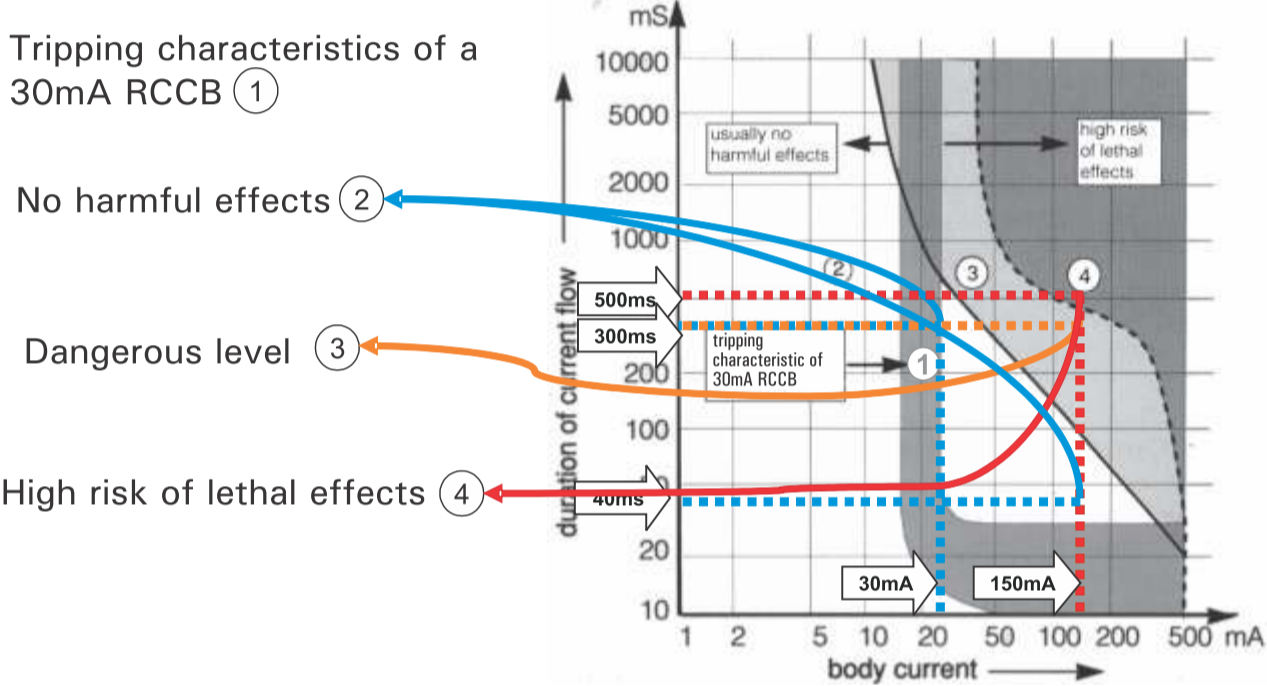

Human Body's reaction to Electric Shock

Dimensions

Miniature Circuit Breaker & Isolator

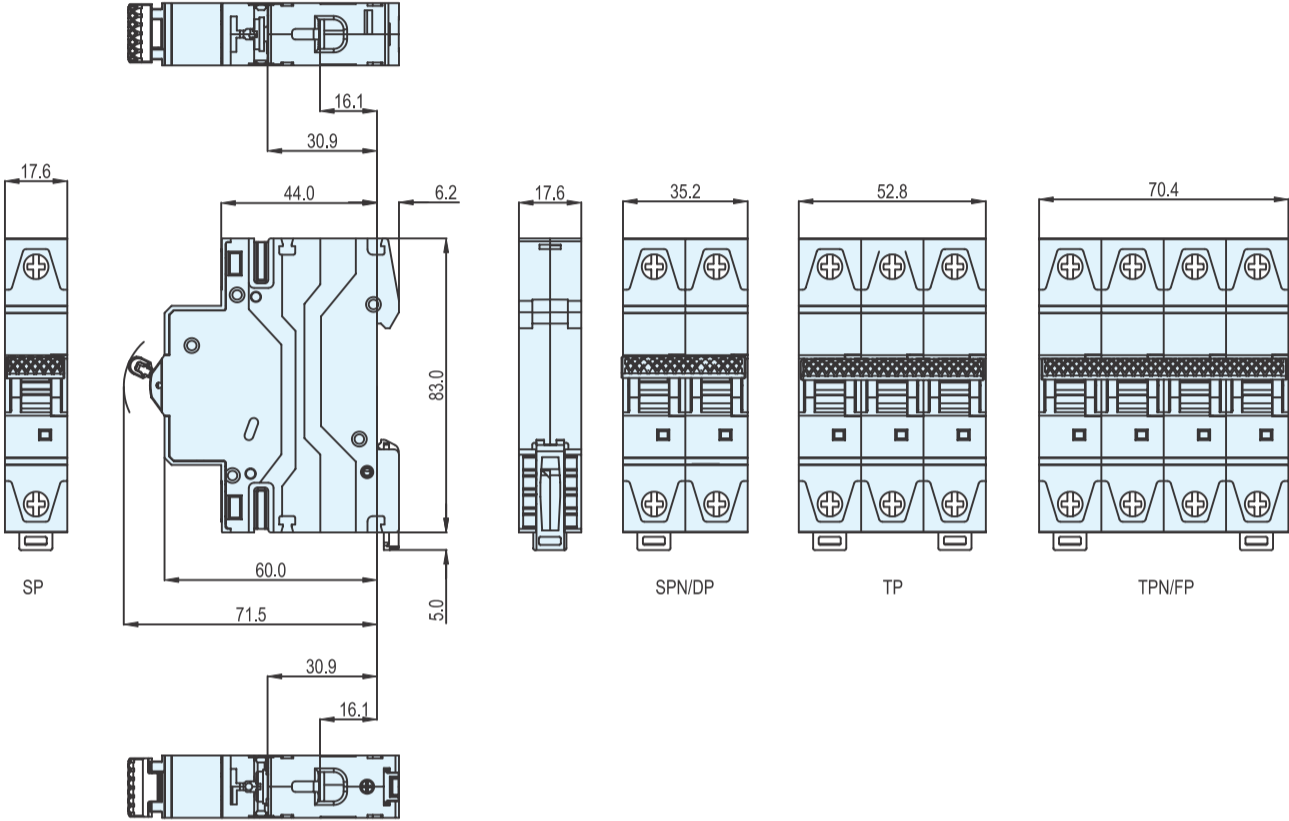

AC Circuit Breaker (80A to 125A)

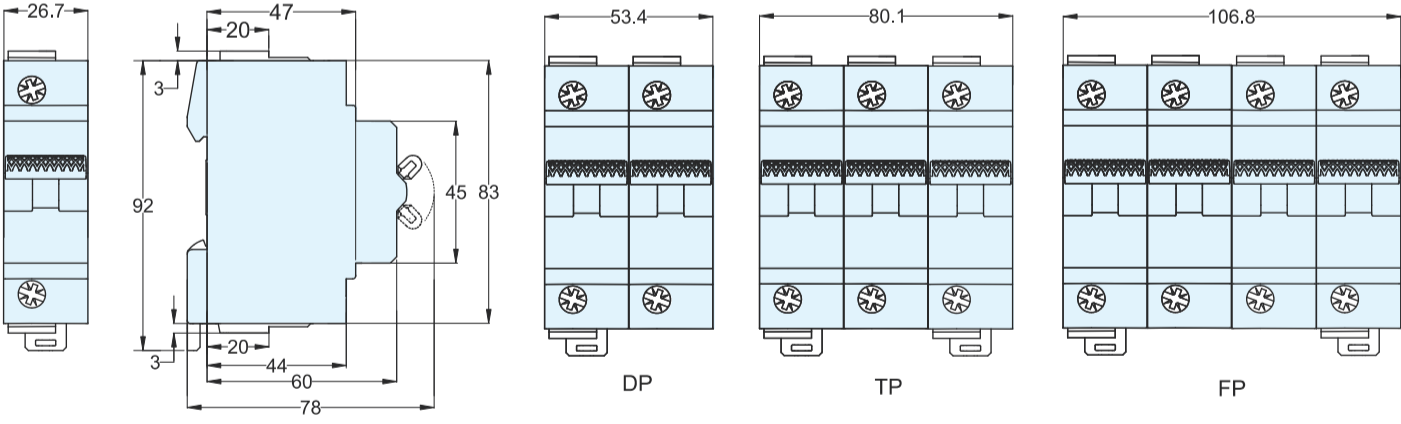

Dimensions

Residual Current Circuit Breaker - DP & FP

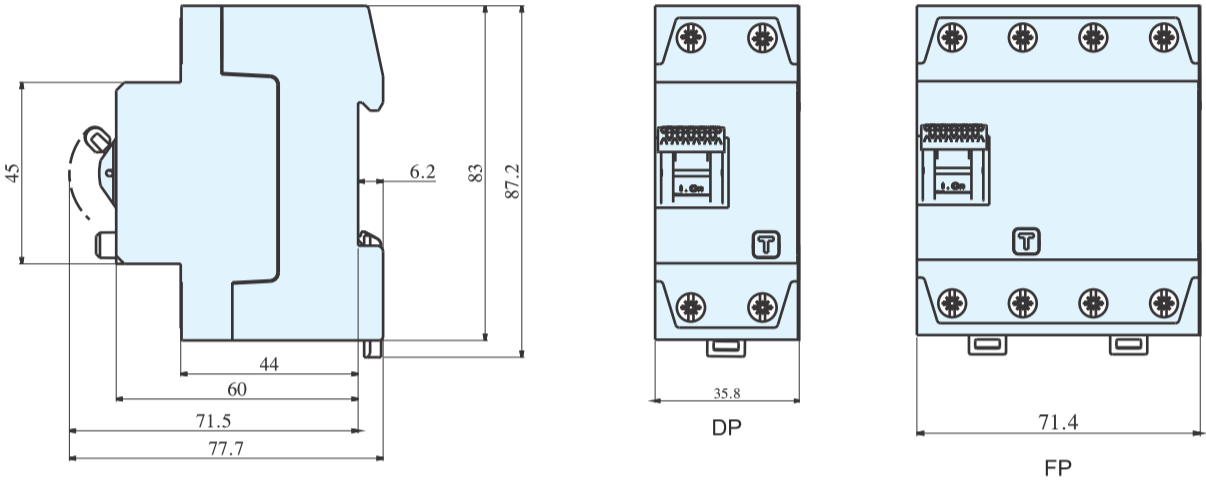

RCD Add on Block - DP & FP

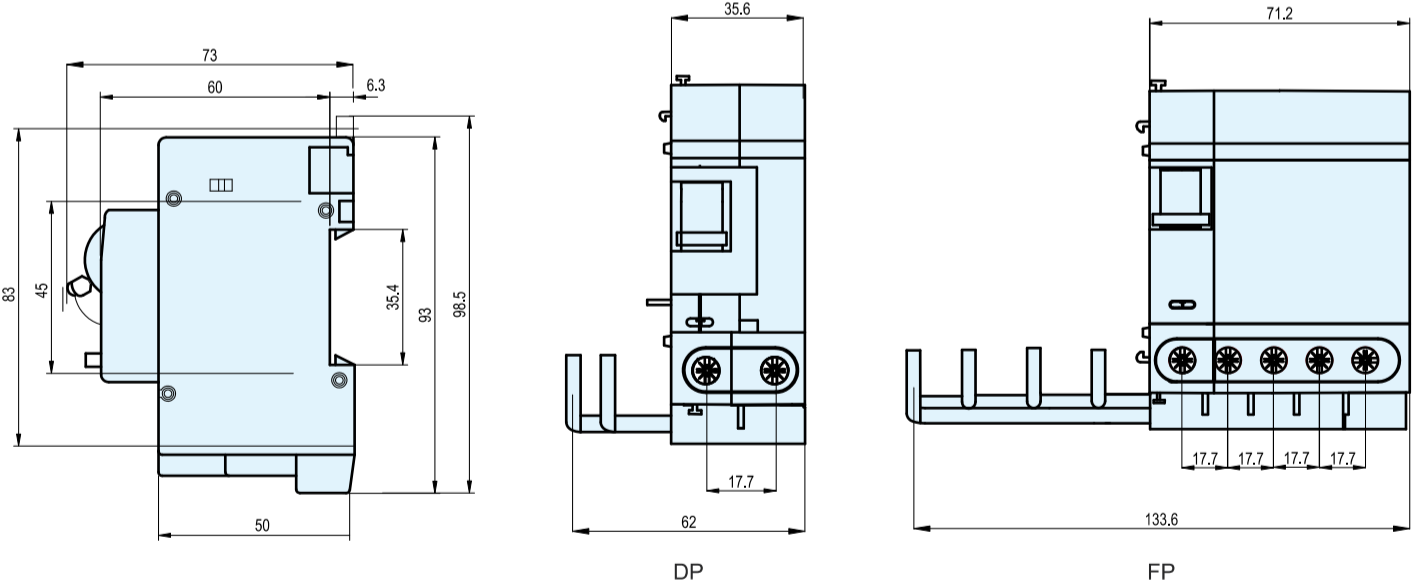

Dimensions

Accessories

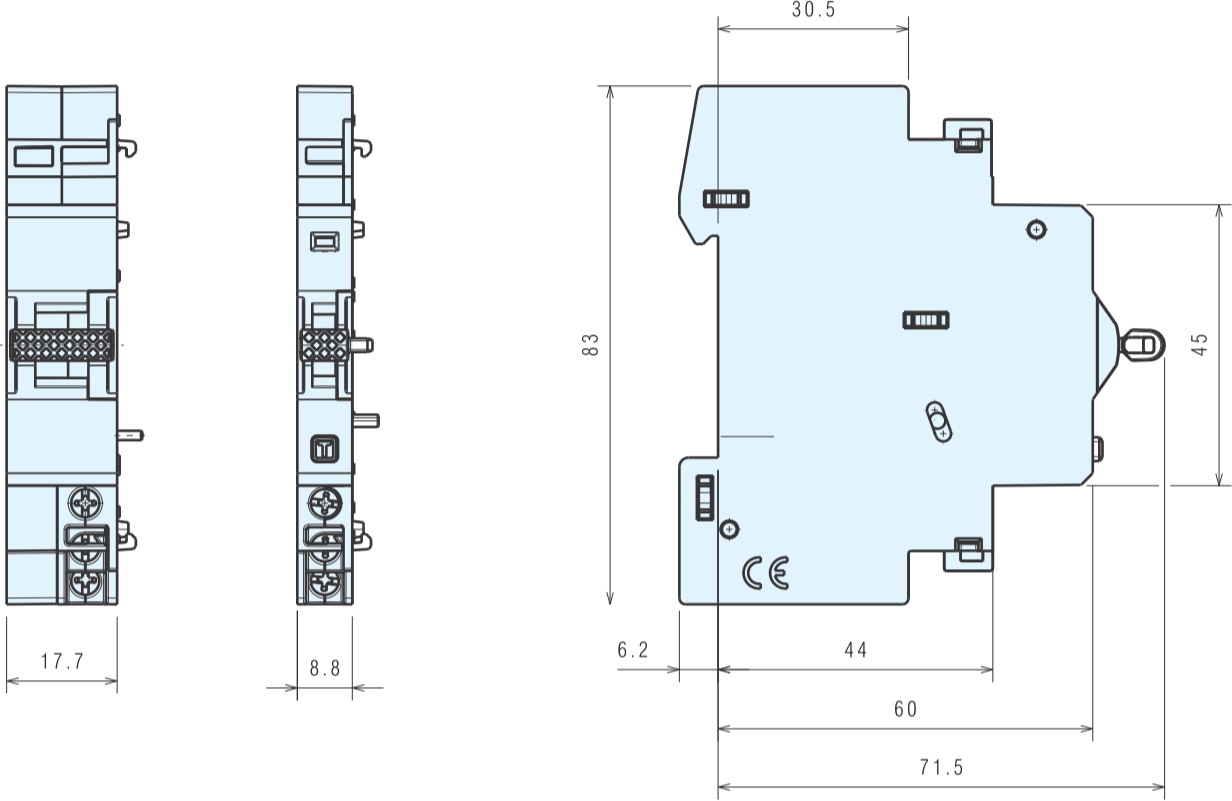

Miniature Circuit Breaker - MCB

- ISI / CE Marked as per IS/IEC 60898 - 1
- Rated Short-Circuit Breaking Capacity, Icn 10kA
- Degree of Protection IP 20
- Energy Limitation Class 3
- Line Load Reversibility
- 35 sq. mm Terminals
- Biconnect Terminals
- Frequency: 50 Hz
- Operating Voltage : 240V / 415V AC , 60V DC per pole

	Cat. Nos. Rating (A) Pack		
	811008	6	1/12/180
811009	7.5	1/12/180	
811010	10	1/12/180	
811011	13	1/12/180	
811012	16	1/12/180	
811013	20	1/12/180	
811014	25	1/12/180	
811015	32	1/12/180	
811016	40	1/12/180	
811017	50	1/12/180	
811018	63	1/12/180	

B Curve Single Pole

	Cat. Nos. Rating (A) Pack		
	811027	6	1/6/90
811028	7.5	1/6/90	
811029	10	1/6/90	
811030	13	1/6/90	
811031	16	1/6/90	
811032	20	1/6/90	
811033	25	1/6/90	
811034	32	1/6/90	
811035	40	1/6/90	
811036	50	1/6/90	
811037	63	1/6/90	

B Curve Single Pole Neutral

	Cat. Nos. Rating (A) Pack		
	811046	6	1/6/90
811047	7.5	1/6/90	
811048	10	1/6/90	
811049	13	1/6/90	
811050	16	1/6/90	
811051	20	1/6/90	
811052	25	1/6/90	
811053	32	1/6/90	
811054	40	1/6/90	
811055	50	1/6/90	
811056	63	1/6/90	

B Curve Double Pole

	Cat. Nos. Rating (A) Pack		
	811114	0.5	1/12/180
811115	1	1/12/180	
811116	1.6	1/12/180	
811117	2	1/12/180	
811119	3	1/12/180	
811120	4	1/12/180	
811121	5	1/12/180	
811122	6	1/12/180	
811123	7.5	1/12/180	
811124	10	1/12/180	
811125	13	1/12/180	
811126	16	1/12/180	
811127	20	1/12/180	
811128	25	1/12/180	
811129	32	1/12/180	
811130	40	1/12/180	
811131	50	1/12/180	
811132	63	1/12/180	

C Curve Single Pole

Miniature Circuit Breaker - MCB

	Cat. Nos.	Rating (A)	Pack
	811136	0.5	1/6/90
	811137	1	1/6/90
	811138	1.6	1/6/90
	811139	2	1/6/90
	811141	3	1/6/90
	811142	4	1/6/90
	811143	5	1/6/90
	811144	6	1/6/90
	811145	7.5	1/6/90
	811146	10	1/6/90
	811147	13	1/6/90
	811148	16	1/6/90
	811149	20	1/6/90
	811150	25	1/6/90
	811151	32	1/6/90
	811152	40	1/6/90
811153	50	1/6/90	
811154	63	1/6/90	

**C Curve
Single Pole
Neutral**

	Cat. Nos.	Rating (A)	Pack
	811180	0.5	1/4/60
	811181	1	1/4/60
	811182	1.6	1/4/60
	811183	2	1/4/60
	811185	3	1/4/60
	811186	4	1/4/60
	811187	5	1/4/60
	811188	6	1/4/60
	811189	7.5	1/4/60
	811190	10	1/4/60
	811191	13	1/4/60
	811192	16	1/4/60
	811193	20	1/4/60
	811194	25	1/4/60
	811195	32	1/4/60
	811196	40	1/4/60
811197	50	1/4/60	
811198	63	1/4/60	

**C Curve
Three Pole**

	Cat. Nos.	Rating (A)	Pack
	811158	0.5	1/6/90
	811159	1	1/6/90
	811160	1.6	1/6/90
	811161	2	1/6/90
	811163	3	1/6/90
	811164	4	1/6/90
	811165	5	1/6/90
	811166	6	1/6/90
	811167	7.5	1/6/90
	811168	10	1/6/90
	811169	13	1/6/90
	811170	16	1/6/90
	811171	20	1/6/90
	811172	25	1/6/90
	811173	32	1/6/90
	811174	40	1/6/90
811175	50	1/6/90	
811176	63	1/6/90	

**C Curve
Double Pole**

	Cat. Nos.	Rating (A)	Pack
	811202	0.5	1/3/45
	811203	1	1/3/45
	811204	1.6	1/3/45
	811205	2	1/3/45
	811207	3	1/3/45
	811208	4	1/3/45
	811209	5	1/3/45
	811210	6	1/3/45
	811211	7.5	1/3/45
	811212	10	1/3/45
	811213	13	1/3/45
	811214	16	1/3/45
	811215	20	1/3/45
	811216	25	1/3/45
	811217	32	1/3/45
	811218	40	1/3/45
811219	50	1/3/45	
811220	63	1/3/45	

**C Curve
Three Pole
Neutral**

Miniature Circuit Breaker - MCB



Cat. Nos.	Rating (A)	Pack
811224	0.5	1/3/45
811225	1	1/3/45
811226	1.6	1/3/45
811227	2	1/3/45
811229	3	1/3/45
811230	4	1/3/45
811231	5	1/3/45
811232	6	1/3/45
811233	7.5	1/3/45
811234	10	1/3/45
811235	13	1/3/45
811236	16	1/3/45
811237	20	1/3/45
811238	25	1/3/45
811239	32	1/3/45
811240	40	1/3/45
811241	50	1/3/45
811242	63	1/3/45

**C Curve
Four Pole**



Cat. Nos.	Rating (A)	Pack
811284	0.5	1/6/90
811285	1	1/6/90
811286	1.6	1/6/90
811287	2	1/6/90
811289	3	1/6/90
811290	4	1/6/90
811291	5	1/6/90
811292	6	1/6/90
811293	7.5	1/6/90
811294	10	1/6/90
811295	13	1/6/90
811296	16	1/6/90
811297	20	1/6/90
811298	25	1/6/90
811299	32	1/6/90
811300	40	1/6/90
811301	50	1/6/90
811302	63	1/6/90

**D Curve
Double Pole**



Cat. Nos.	Rating (A)	Pack
811246	0.5	1/12/180
811247	1	1/12/180
811248	1.6	1/12/180
811249	2	1/12/180
811251	3	1/12/180
811252	4	1/12/180
811253	5	1/12/180
811254	6	1/12/180
811255	7.5	1/12/180
811256	10	1/12/180
811257	13	1/12/180
811258	16	1/12/180
811259	20	1/12/180
811260	25	1/12/180
811261	32	1/12/180
811262	40	1/12/180
811263	50	1/12/180
811264	63	1/12/180

**D Curve
Single Pole**



Cat. Nos.	Rating (A)	Pack
811303	0.5	1/4/60
811304	1	1/4/60
811305	1.6	1/4/60
811306	2	1/4/60
811308	3	1/4/60
811309	4	1/4/60
811310	5	1/4/60
811311	6	1/4/60
811312	7.5	1/4/60
811313	10	1/4/60
811314	13	1/4/60
811315	16	1/4/60
811316	20	1/4/60
811317	25	1/4/60
811318	32	1/4/60
811319	40	1/4/60
811320	50	1/4/60
811321	63	1/4/60

**D Curve
Three Pole**

Miniature Circuit Breaker - MCB

 D Curve Four Pole	Cat. Nos.	Rating (A)	Pack
	811341	0.5	1/3/45
	811342	1	1/3/45
	811343	1.6	1/3/45
	811344	2	1/3/45
	811346	3	1/3/45
	811347	4	1/3/45
	811348	5	1/3/45
	811349	6	1/3/45
	811350	7.5	1/3/45
	811351	10	1/3/45
	811352	13	1/3/45
	811353	16	1/3/45
	811354	20	1/3/45
	811355	25	1/3/45
	811356	32	1/3/45
	811357	40	1/3/45
811358	50	1/3/45	
811359	63	1/3/45	

AC Circuit Breaker

- Conforms to IEC 60947 - 2
- CE Marked
- Rated Short-Circuit Capacity, Icu 10kA
- Degree of Protection IP 20
- 1.5 Module per pole
- 50 sq. mm Terminals
- Frequency: 50 Hz
- Operating Voltage: 240V/415V AC, 60V DC per Pole

 Single Pole	Cat. Nos.	Rating (A)	Pack
	811133	80	1
	811134	100	1
	811135	125	1

 Three Pole	Cat. Nos.	Rating (A)	Pack
	811199	80	1
	811200	100	1
	811201	125	1

 Double Pole	Cat. Nos.	Rating (A)	Pack
	811177	80	1
	811178	100	1
	811179	125	1

 Four Pole	Cat. Nos.	Rating (A)	Pack
	811243	80	1
	811244	100	1
	811245	125	1

DC Circuit Breaker

- Conforms to IEC 60947 - 2
- CE Marked
- Breaking Capacity 6kA
- Degree of Protection IP 20
- 35 sq. mm Terminals
- Biconnect Terminals
- Upto 250V Supply

	Cat. Nos.	Rating (A)	Pack
	811400	0.5	1/12/180
	811401	1	1/12/180
	811402	1.6	1/12/180
	811403	2	1/12/180
	811405	3	1/12/180
	811406	4	1/12/180
	811407	5	1/12/180
	811408	6	1/12/180
	811409	7.5	1/12/180
	811410	10	1/12/180
	811411	13	1/12/180
	811412	16	1/12/180
	811413	20	1/12/180
	811414	25	1/12/180
	811415	32	1/12/180
	811416	40	1/12/180
	811417	50	1/12/180
	811418	63	1/12/180

Single Pole

	Cat. Nos.	Rating (A)	Pack
	811419	0.5	1/6/90
	811420	1	1/6/90
	811421	1.6	1/6/90
	811422	2	1/6/90
	811424	3	1/6/90
	811425	4	1/6/90
	811426	5	1/6/90
	811427	6	1/6/90
	811428	7.5	1/6/90
	811429	10	1/6/90
	811430	13	1/6/90
	811431	16	1/6/90
	811432	20	1/6/90
	811433	25	1/6/90
	811434	32	1/6/90
	811435	40	1/6/90
	811436	50	1/6/90
	811437	63	1/6/90

Double Pole

Isolator

- Conforms to IEC 60947-3
- CE Marked
- Degree of Protection IP 20
- 35 sq. mm Terminals
- Biconnect Terminals
- Frequency: 50 Hz
- Operating Voltage: 240V/415V AC, 60V DC per Pole

	Cat. Nos.	Rating (A)	Pack
	811550	40	1/6/90
	811551	63	1/6/90
	811552	80	1/6/90
	811553	100	1/6/90
	811554	125	1/6/90

Double Pole

	Cat. Nos.	Rating (A)	Pack
	811555	40	1/4/60
	811556	63	1/4/60
	811557	80	1/4/60
	811558	100	1/4/60
	811559	125	1/4/60

Three Pole

	Cat. Nos.	Rating (A)	Pack
	811560	40	1/3/45
	811561	63	1/3/45
	811562	80	1/3/45
	811563	100	1/3/45
	811564	125	1/3/45

Four Pole

Residual Current Circuit Breaker - RCCB

- ISI/CE Marked as per IS/IEC 12640 - 1
- Degree of Protection IP 20
- Rated Conditional Short-Circuit Current, Inc 10kA
- 35 sq. mm Terminals
- Biconnect Terminals
- Frequency: 50 Hz
- Operating Voltage: 240V/415V AC

	Rating (A)	Sensitivity (mA)	Cat. Nos.	Pack
	25		30	811700
		100	811706	1/6/90
		300	811712	1/6/90
40		30	811701	1/6/90
		100	811707	1/6/90
		300	811713	1/6/90
63		30	811702	1/6/90
		100	811708	1/6/90
		300	811714	1/6/90

Double Pole

	Rating (A)	Sensitivity (mA)	Cat. Nos.	Pack
	25		30	811718
		100	811724	1/3/45
		300	811730	1/3/45
40		30	811719	1/3/45
		100	811725	1/3/45
		300	811731	1/3/45
63		30	811720	1/3/45
		100	811726	1/3/45
		300	811732	1/3/45

Four Pole

RCD Add on Block

- Conforms to IEC 60947-2
- Degree of Protection IP 20
- Rated Conditional Short-Circuit Current, I_{cc} 10kA
- 35 sq. mm Terminals
- Dual Position DIN Clip
- Flexibility to use MCB of any Tripping Curve.

 Double Pole	Rating (A)	Sensitivity (mA)	Cat. Nos.	Pack
	6A - 32A	30	811666	1/ - /32
	100	811668	1/ - /32	
	300	811670	1/ - /32	
40A & 63A	30	811667	1/ - /32	
	100	811669	1/ - /32	
	300	811671	1/ - /32	

 Four Pole	Rating (A)	Sensitivity (mA)	Cat. Nos.	Pack
	6A - 32A	30	811672	1/ - /16
	100	811674	1/ - /16	
	300	811676	1/ - /16	
40A & 63A	30	811673	1/ - /16	
	100	811675	1/ - /16	
	300	811677	1/ - /16	

Accessories

- Conforms to IEC 60947 - 5 - 1
- Retro Fit Type Clip On Accessory
- CE Marked
- Upto Three Number of Accessory on a Modular Device
- Common Accessories for Entire Range
- Easy To Install

 Accessories	Item Description	Cat. Nos.	Pack
	Auxiliary Changeover Switch 1NO	811580	1
Fault Signalling Contact 1NC	811581	1	
Shunt Trip 12V to 48V AC/DC	811582	1	
Shunt Trip 110V to 415V AC	811583	1	
Undervoltage 24V & 48V AC/DC	811584	1	
Undervoltage 240V AC	811585	1	



Distribution Boards

Optipro's range of Distribution Boards offers complete solutions with unmatched quality and value. Easy to install and operate, the resourceful design complies with the True IP43 protection standard. The range has fresh and innovative designs that will match with any wall texture.

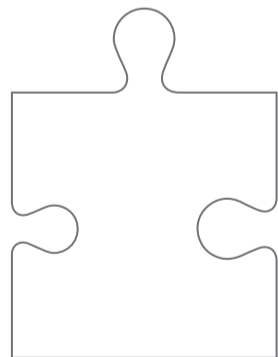

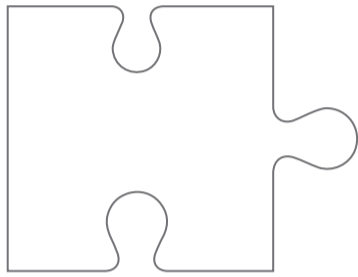

Wide Range

The Optipro range is a complete and thought-through range of Distribution Boards with SPN, TPN, VTPN, Flexi, 7 segment, phase selectors, enclosures and plug & socket types. This range single-handedly answers all your project needs.





Total Safety

True IP43 in its segment

Degree of protection in double door DBs is IP43.
The design is tested as per IEC 60529 for the IP test.
The True IP43 design makes the range suitable for all situations that demand IP43 degree of protection.

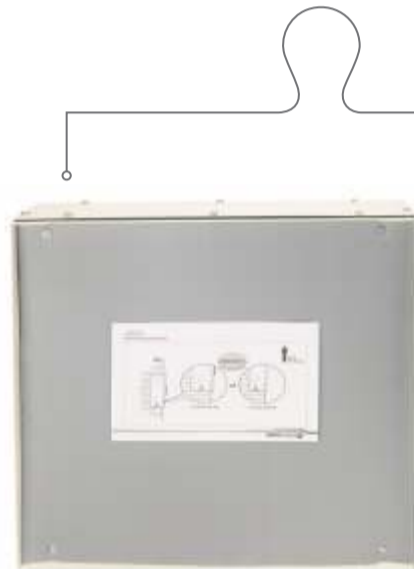

Cement protector

A specially-designed cement protector does not allow cement, dust, etc., to enter the DB during construction. Once construction is complete, the cement protector can be easily removed for wiring, keeping your DB free from dust and damage.

Isolated neutral bar

Once installed, the neutral bar on the Optipro Distribution Board is completely isolated from the box. It is neither visible nor is it accessible to human touch, offering complete protection against the live parts.

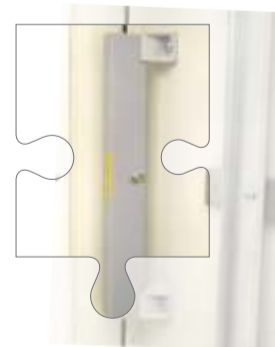



Simple Look

Fresh design

Thanks to its sleek and minimal look, the Optipro Distribution Board looks great on any wall. Its fresh and innovative design has truly transformed Distribution Boards for the future.



Innovative door knob

The knob of the Distribution Board is unique in design to meet all operational needs. The knob is sleek with less projection off the surface. The innovative sliding mechanism grants it a longer life.

New colour & finish

Optipro Distribution Boards come in a new exciting colour that goes well with any decor. The matte finish of the product makes it match well with any wall texture. The finish does not attract dust and keeps the exterior clean.



Plain corners

The Optipro range is engineered to have no sharp edges. Thus, your hand will simply glide over smooth and plain corners when you interact with the product, giving you a safe and stylish Distribution Board.



Ease of Use

Independent shield

The Optipro Distribution Board has an independent shield that is removable when necessary. During maintenance, the shield can be removed, while the door and frame remain in place. This makes operation fast and easy.

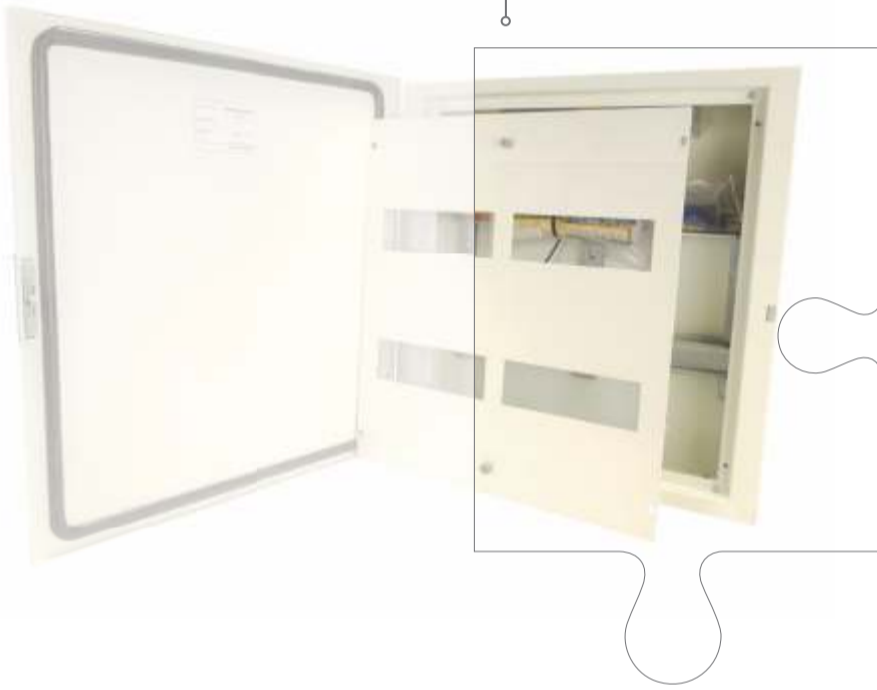

Box separately packed

Optipro presents the concept of twin packaging. Parts like the frame, shield and door are packed separately from the box. Thanks to this insight, installation is made easier for the user. The frame, shield and door can be safely stored until complete wiring and painting is done.



Dimensions

SPN DB Single door

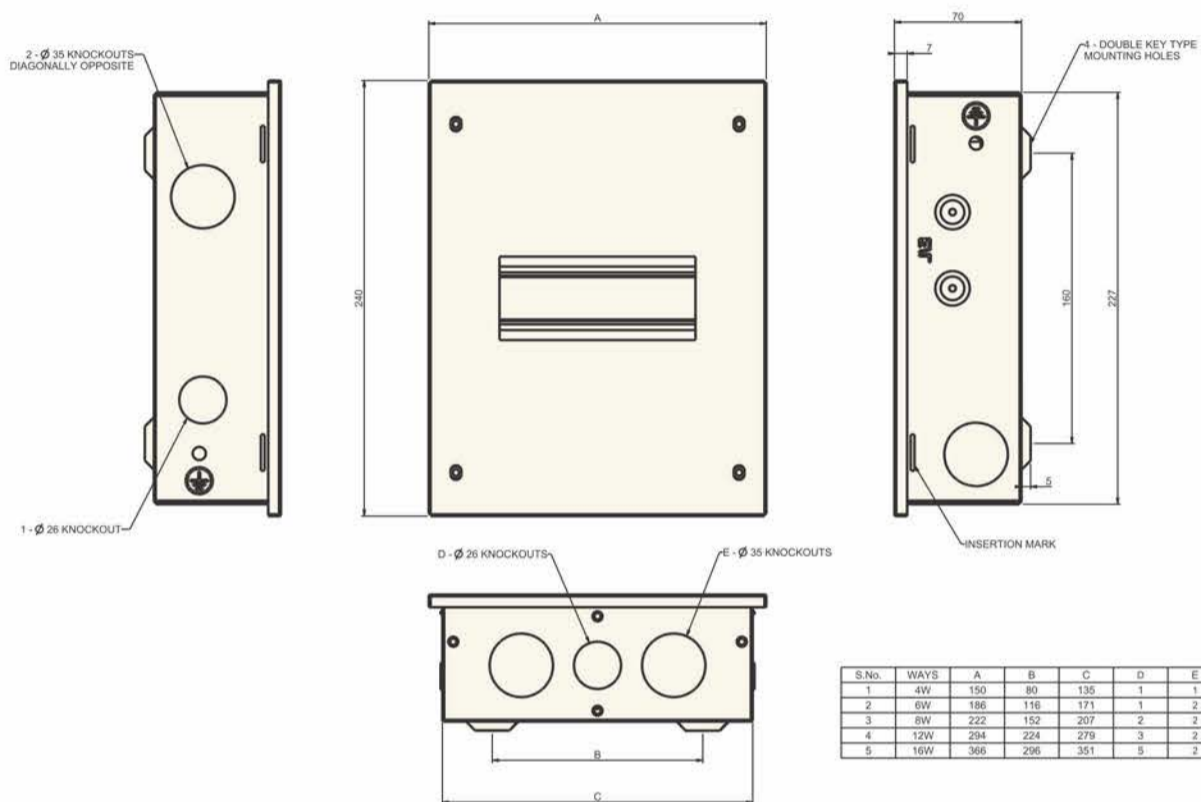

SPN DB Double door

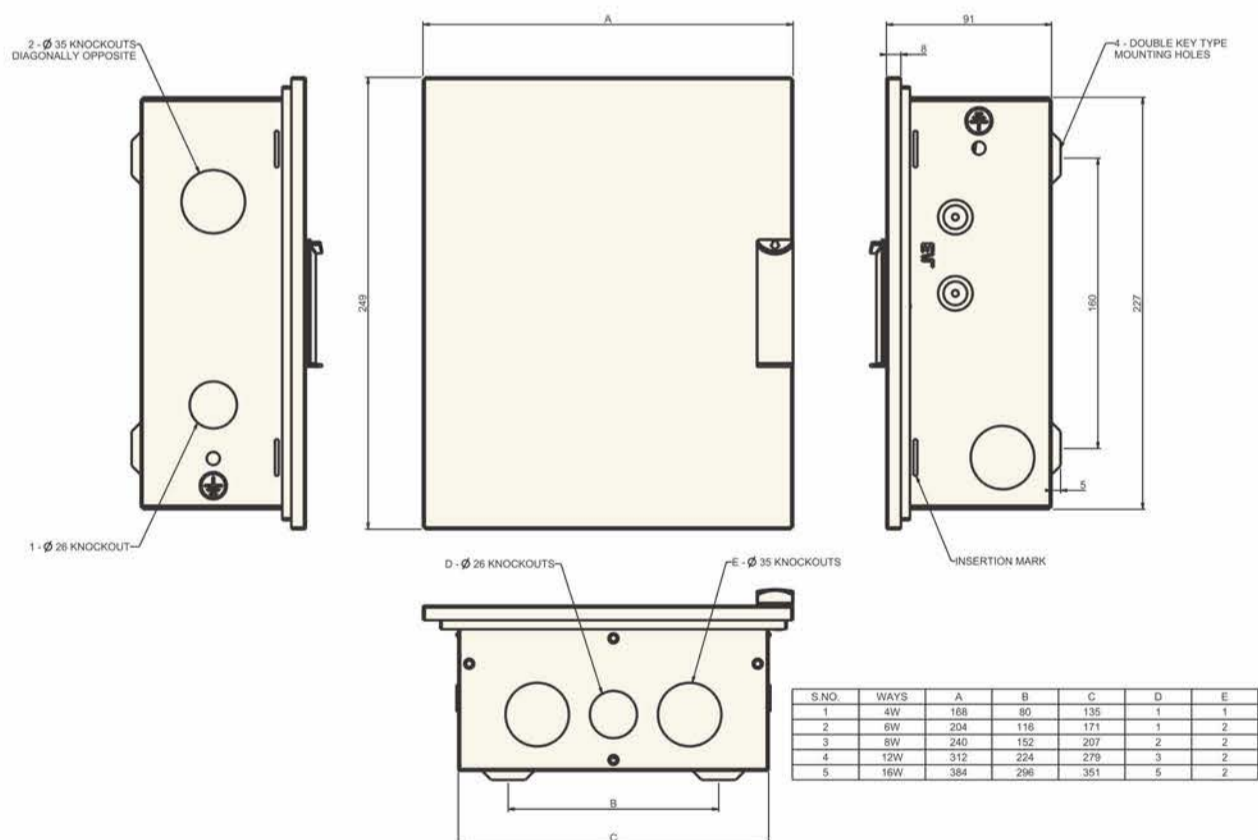

Dimensions

SPN DB Acrylic door

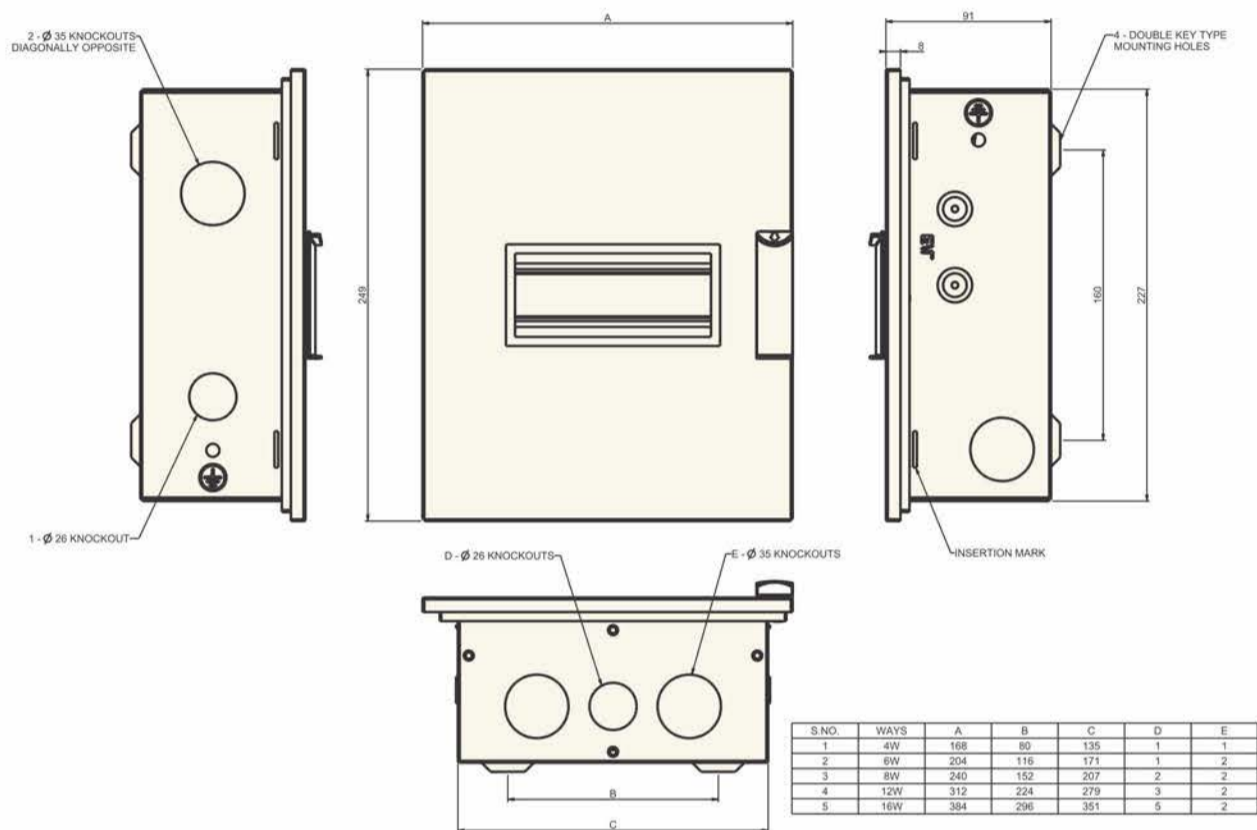

TPN DB Single door

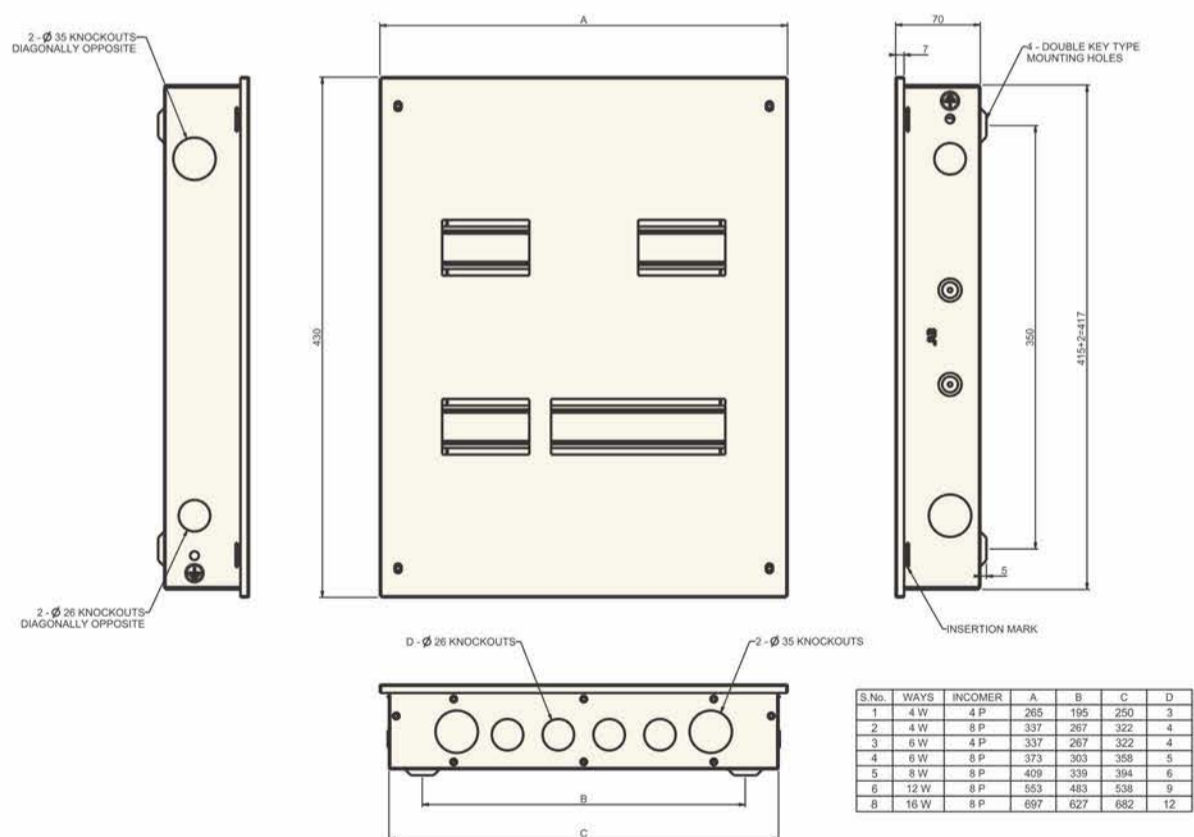

Dimensions

TPN DB Double door

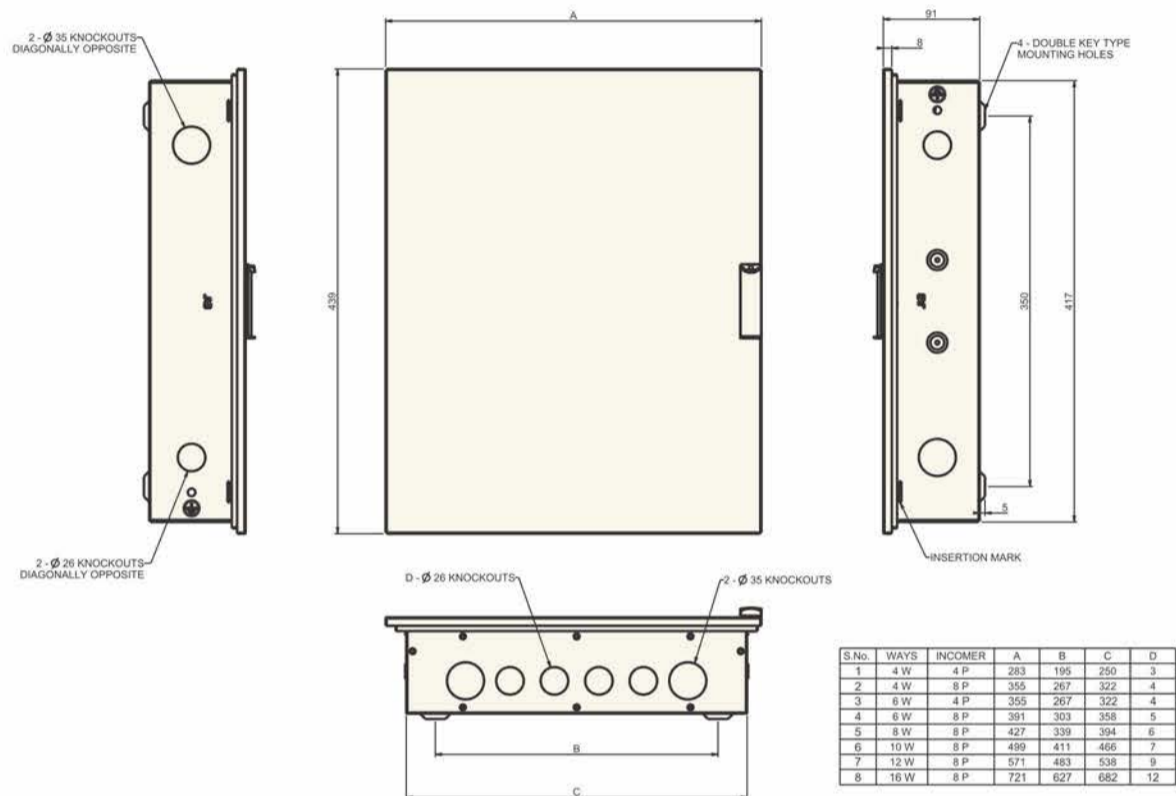

TPN DB Acrylic door

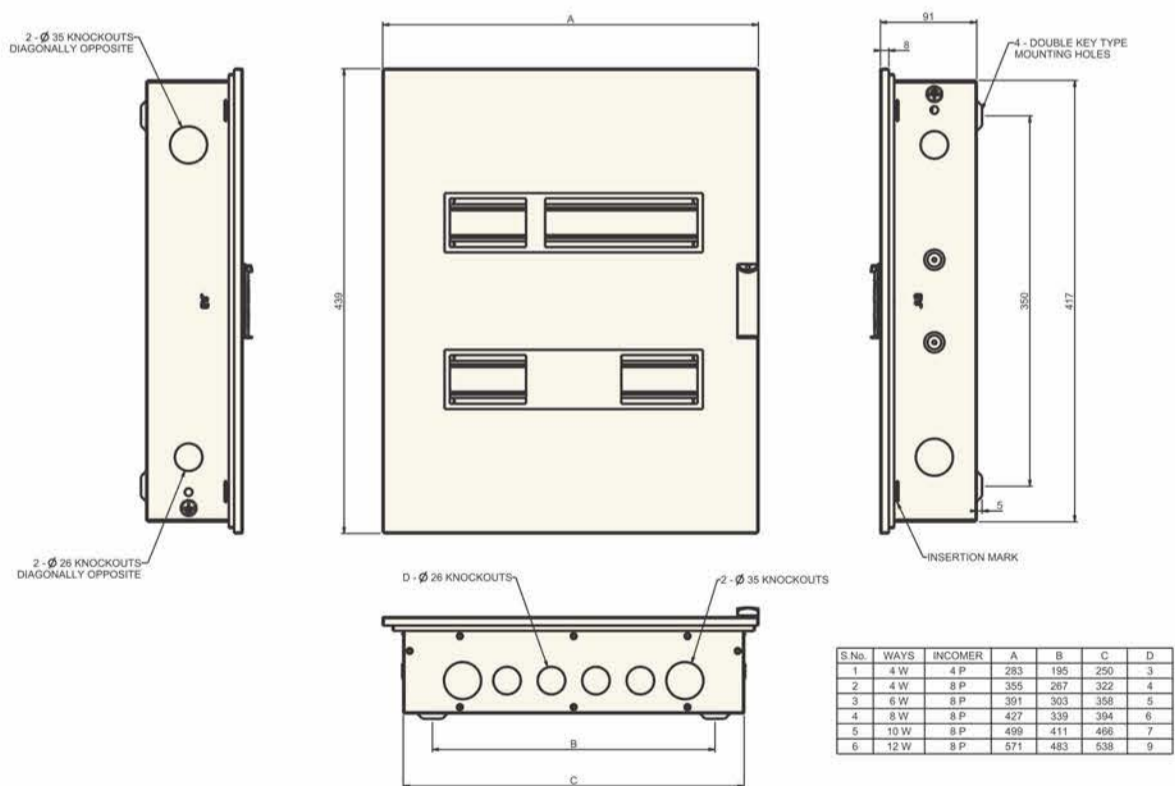

Dimensions

VTPN MCB DB Single door

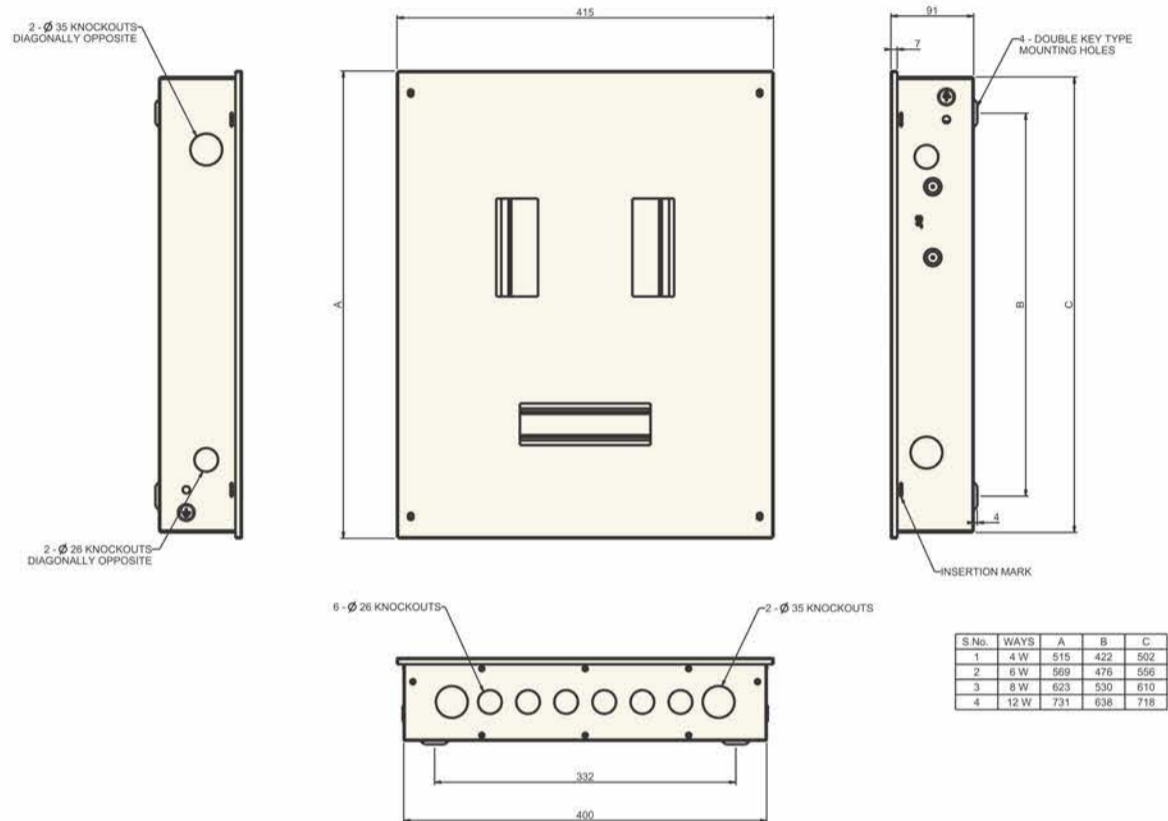

VTPN MCB DB Double door

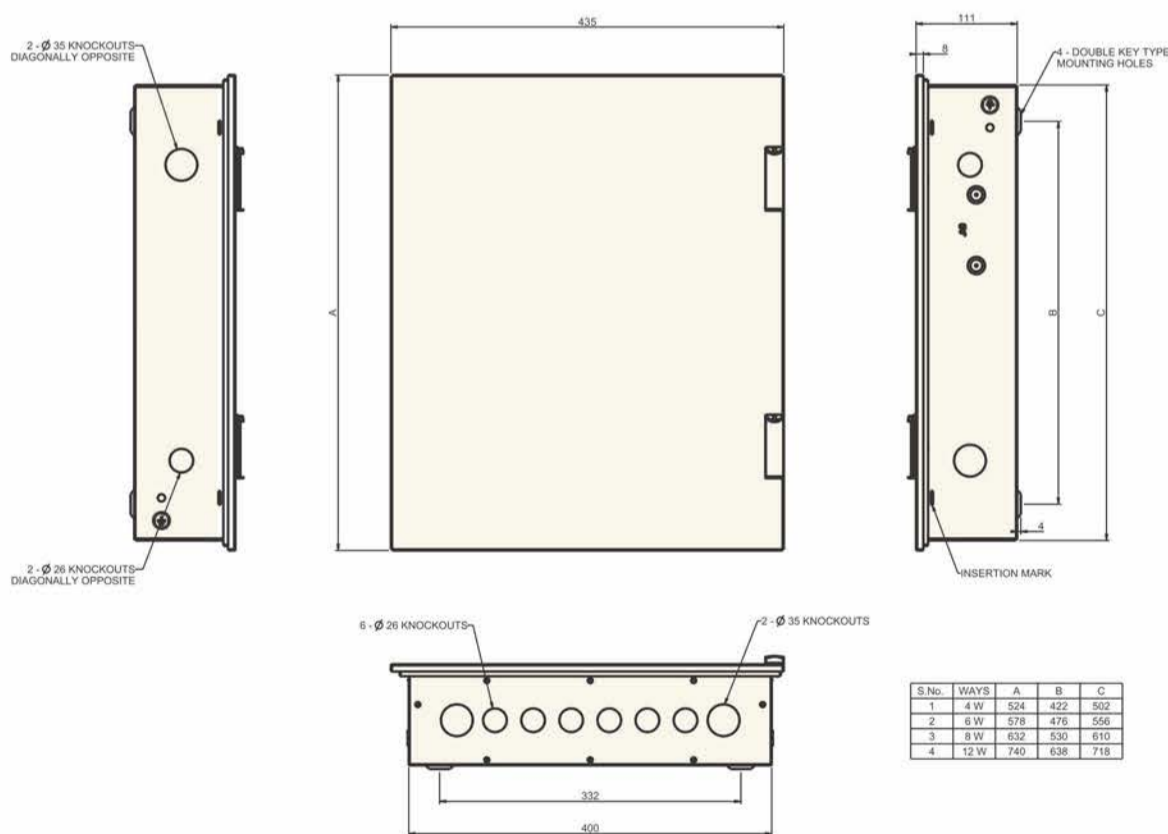

Dimensions

VTPN MCCB 125A DB-Double door

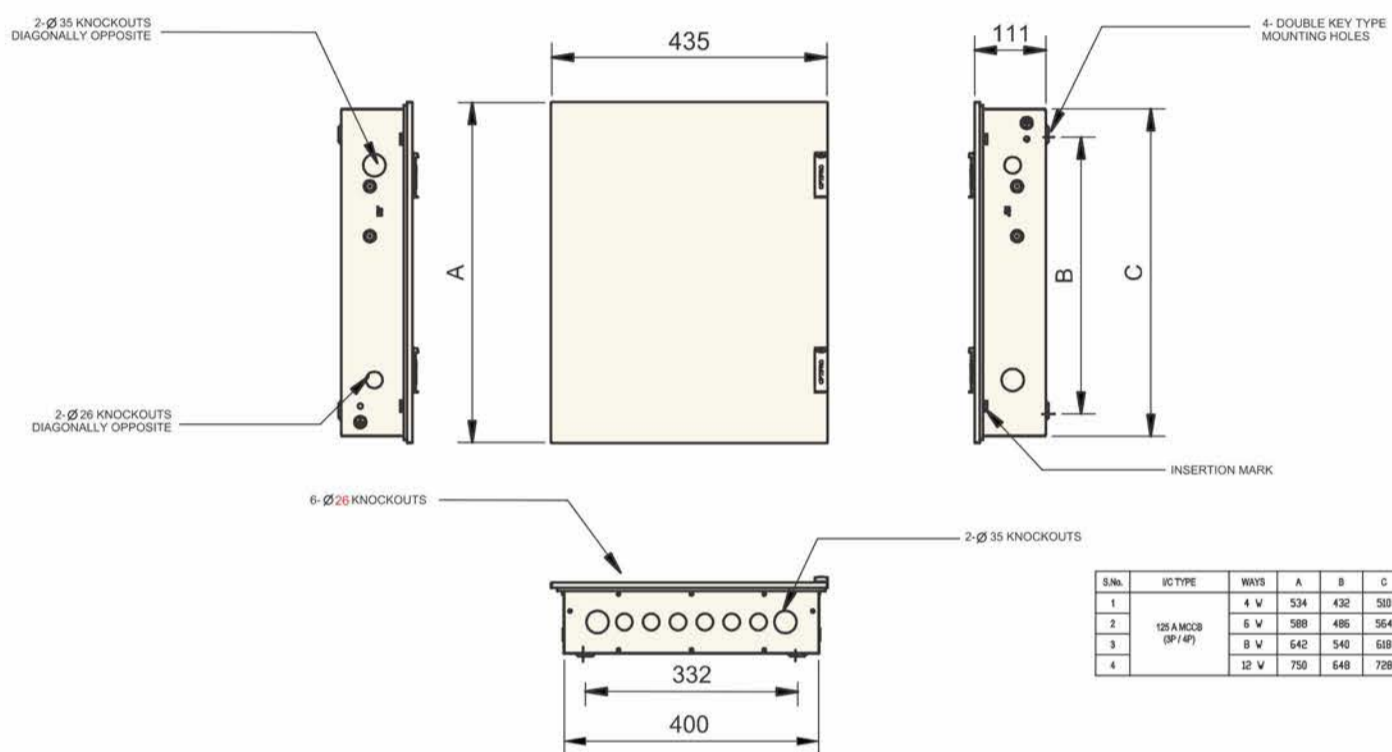

VTPN MCCB 250A DB-Double door

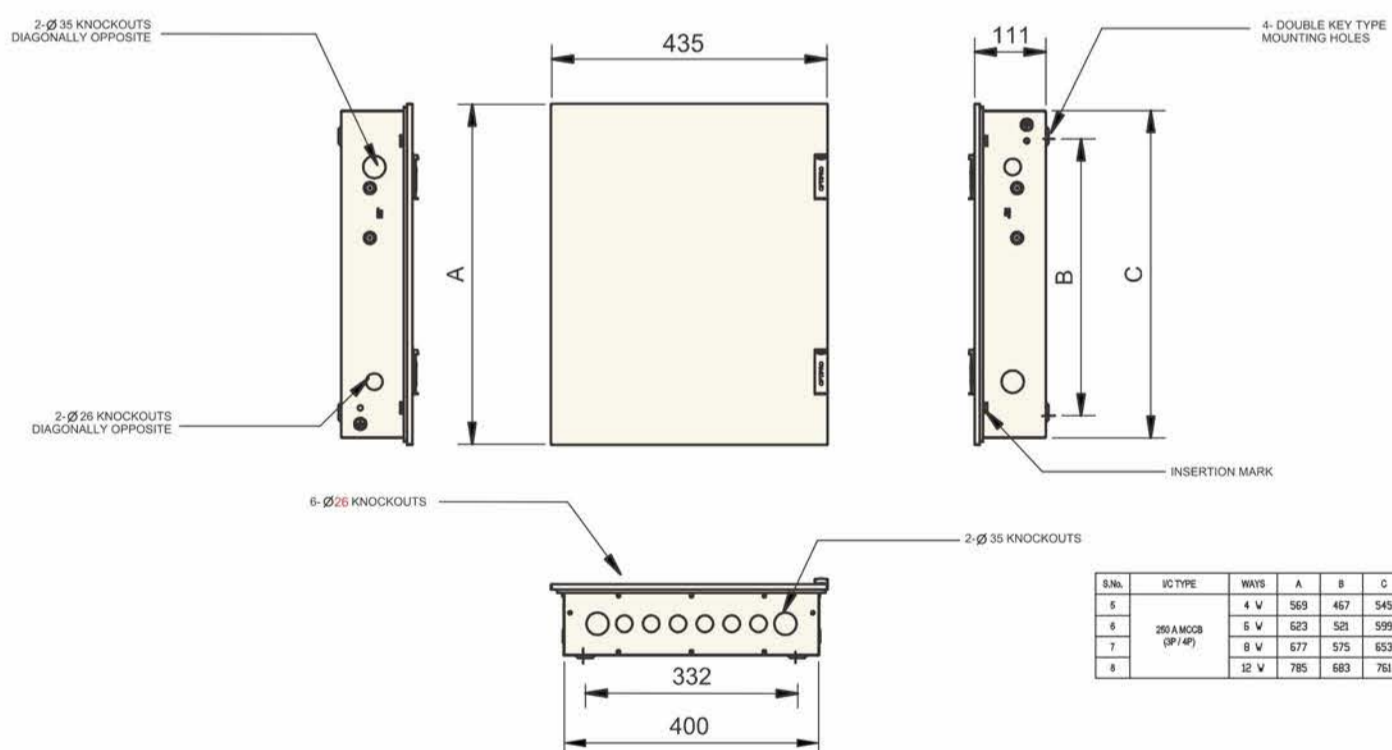

Dimensions

Flexi DB Double door

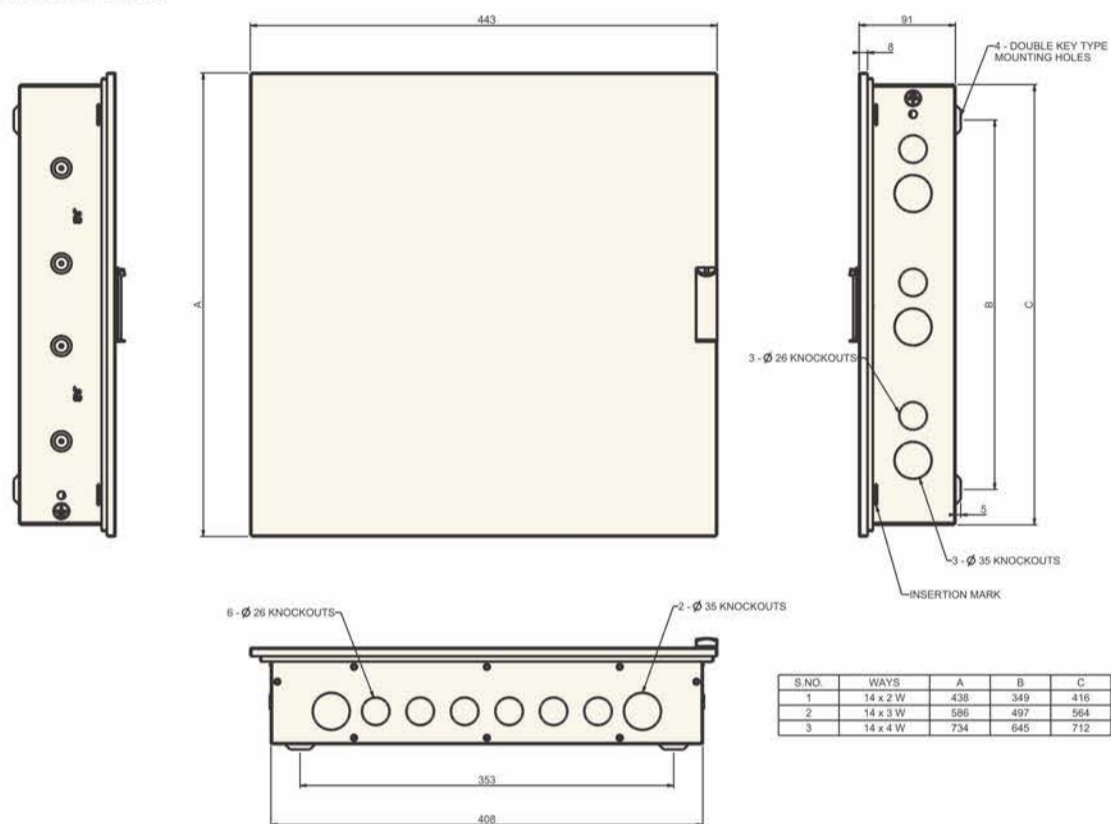

7 Segment DB Double door

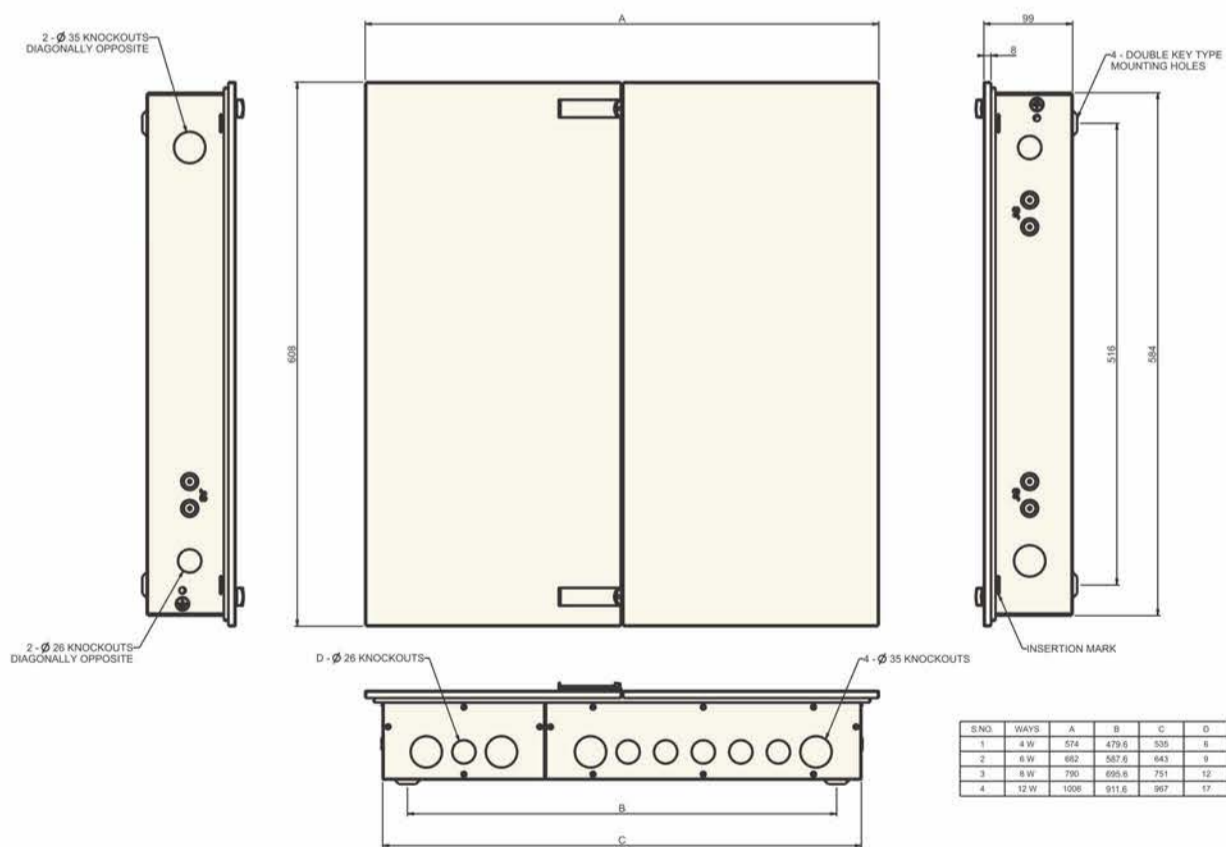

Dimensions

Phase selector DB 40A & 63A Double door

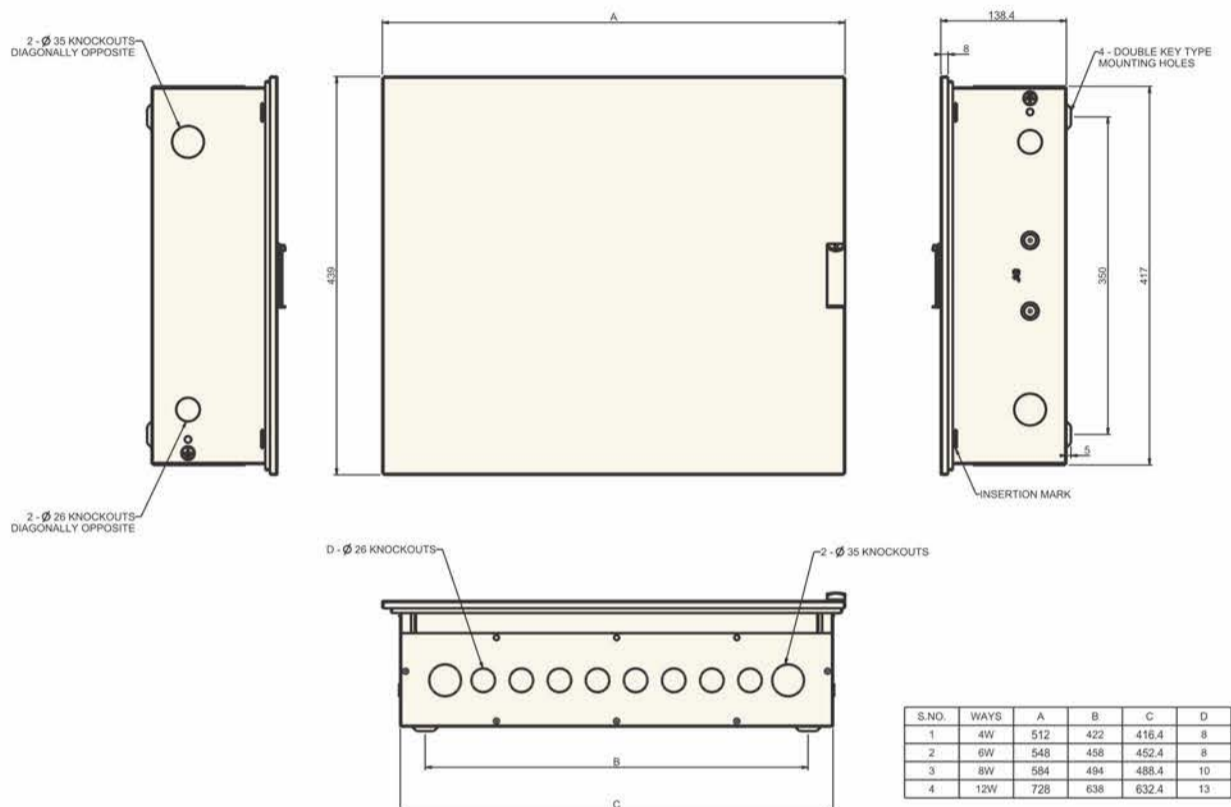

Metal Plug & Socket Box 20A SP & 20A DP

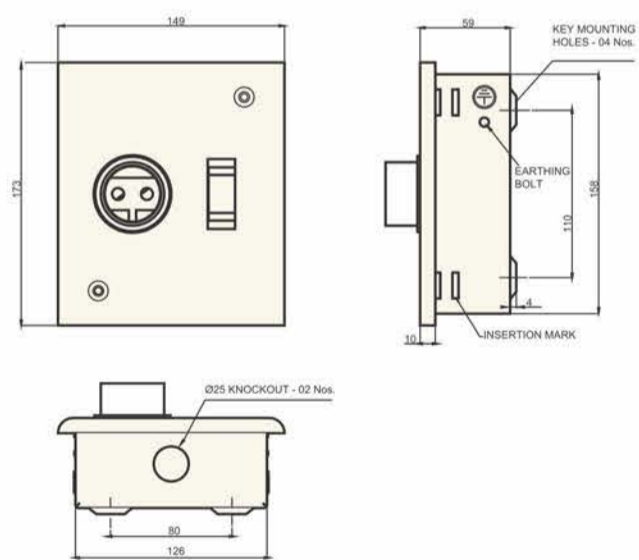

General Tolerance : ± 2.0 mm

Dimensions

Metal Plug & Socket Box 20A & 32A TP

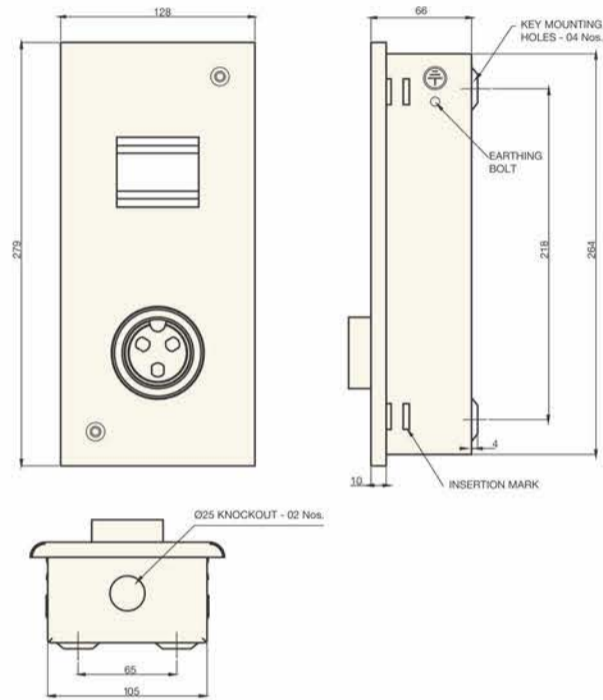

Plastic P&S 16A 3Pin

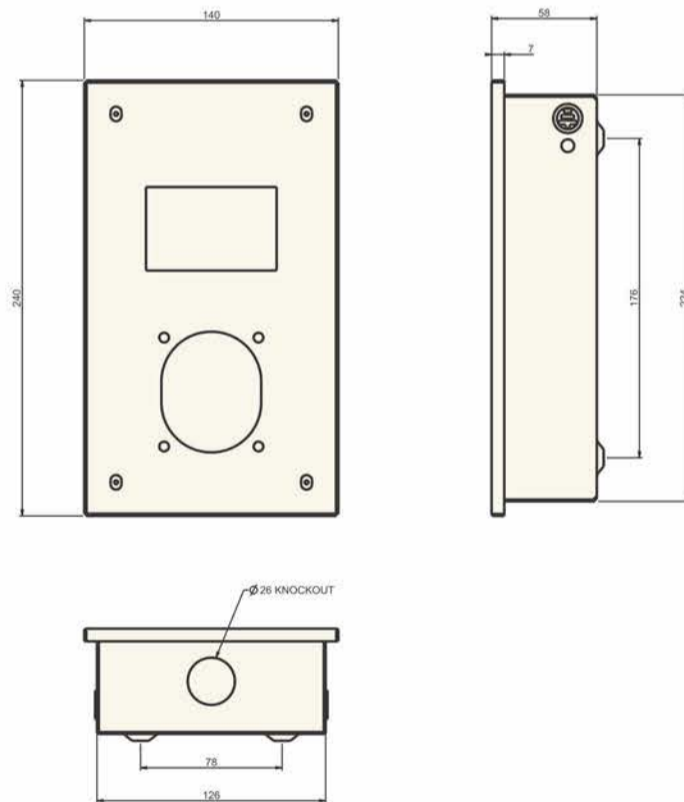

Dimensions

Plastic P&S 32A 3Pin / 5Pin

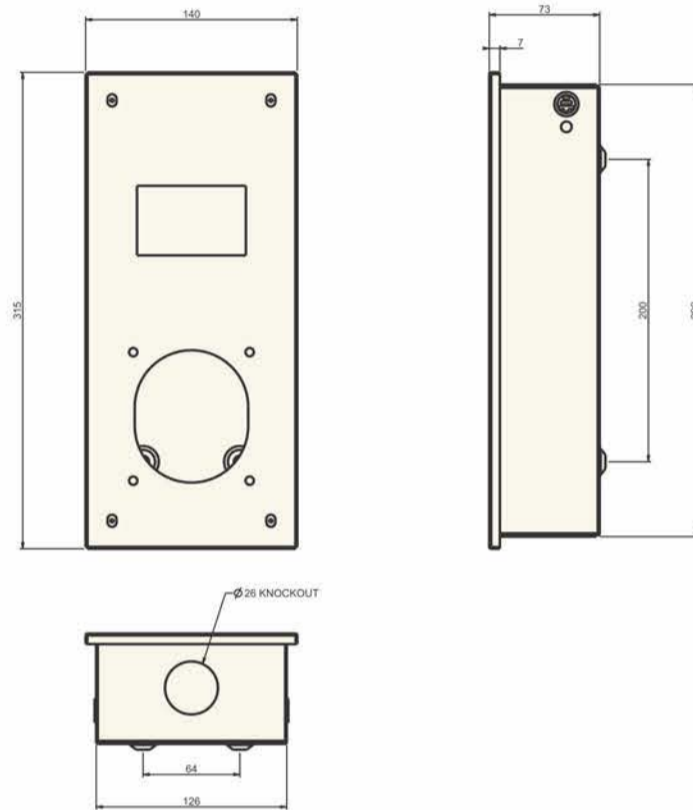

Plastic P&S 63A 5Pin

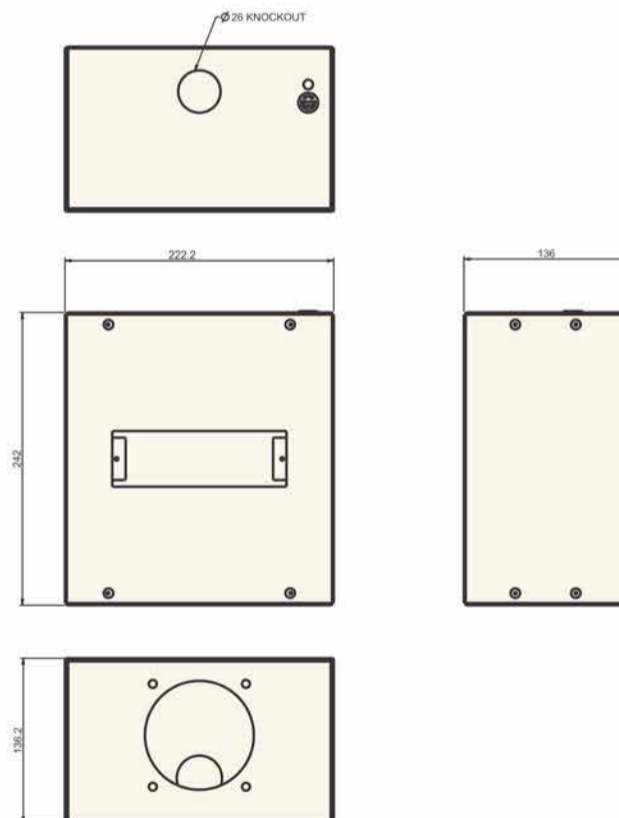

Dimensions

Metal Enclosure

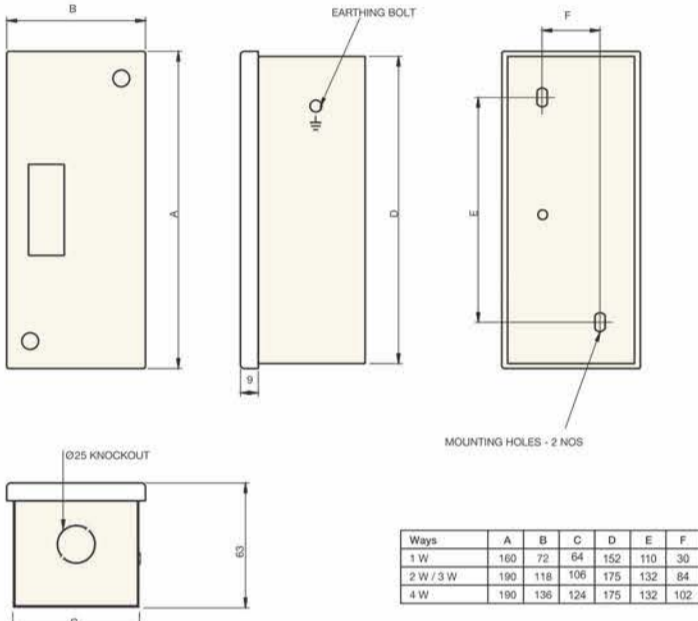

General Tolerance : ±2.0 mm

Plastic Enclosures

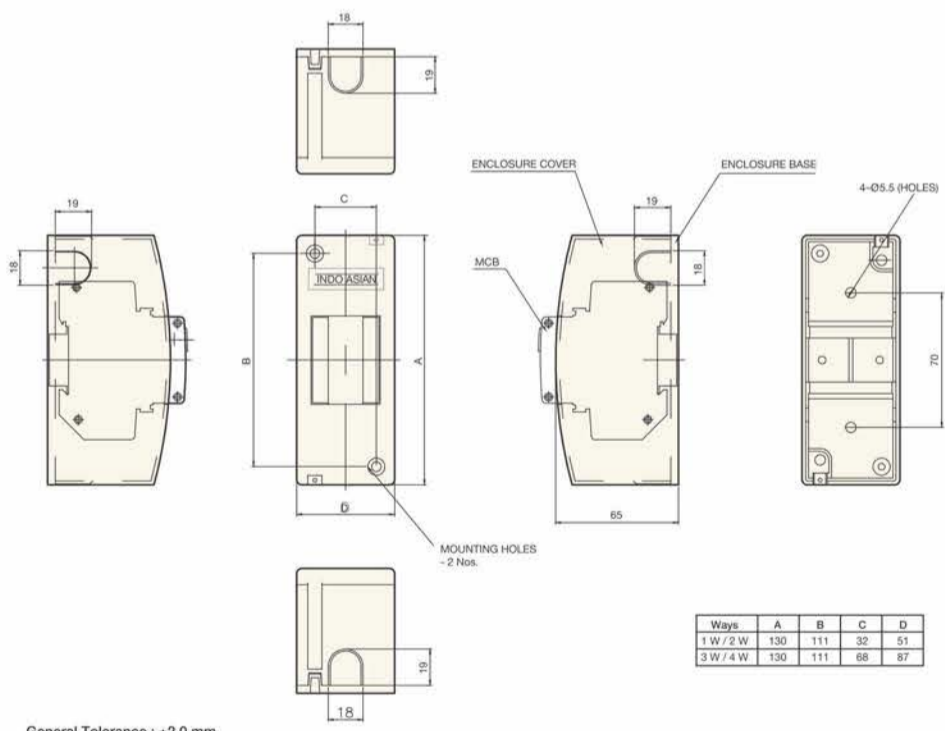

General Tolerance : ±2.0 mm

Dimensions

SPN TV/Tel. DB Double Door

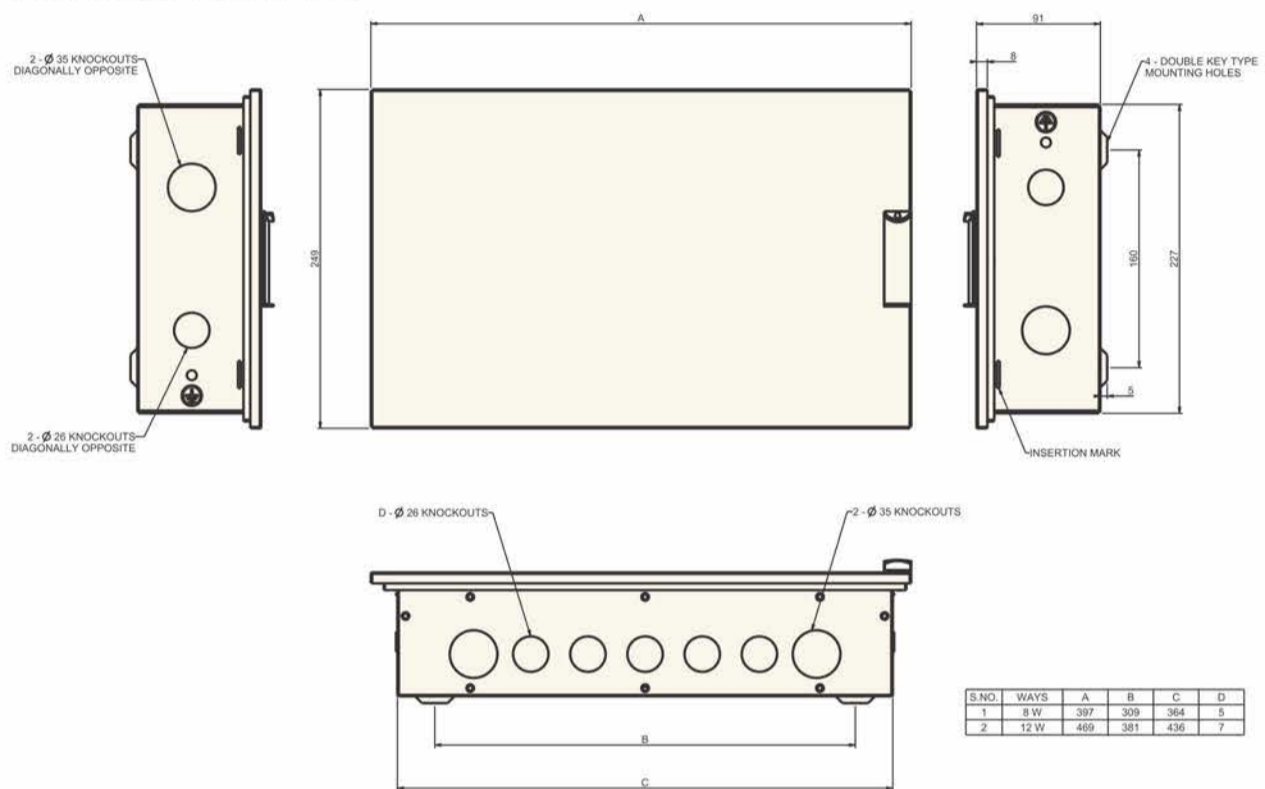

TPN TV/Tel. DB Double Door

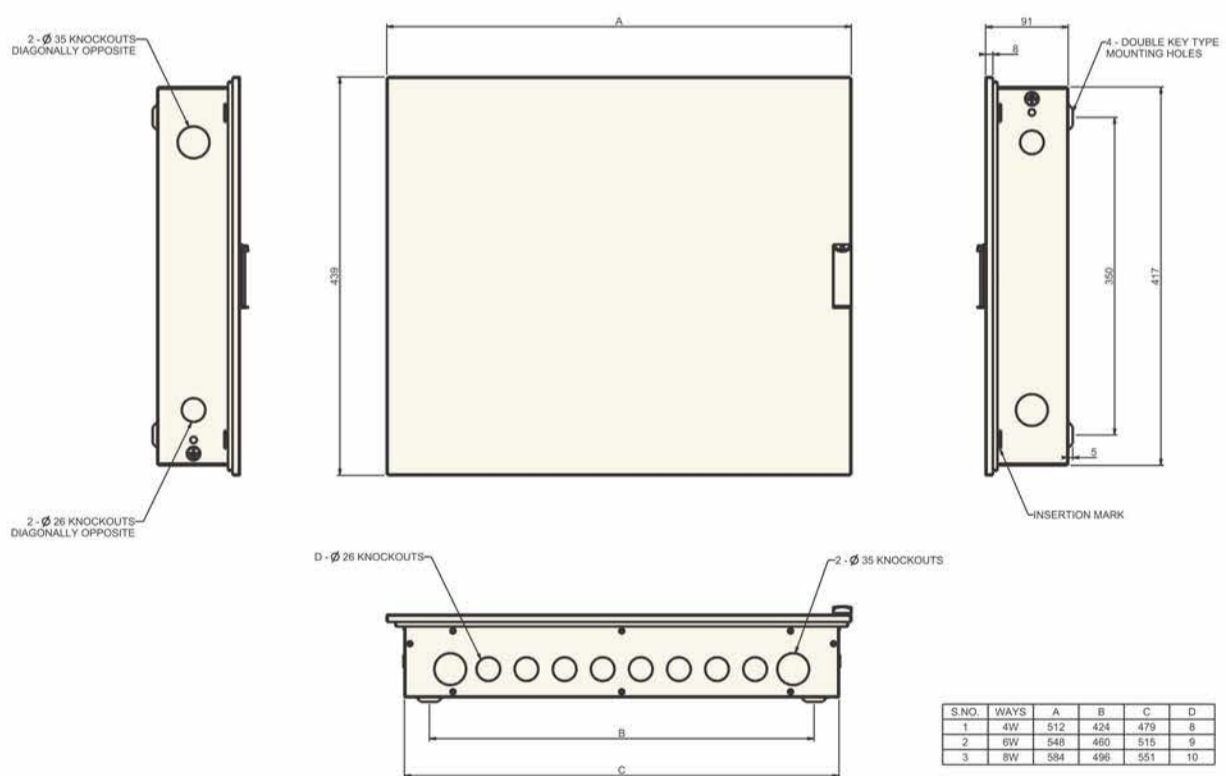

Dimensions

PPI Hor. DB Double Door

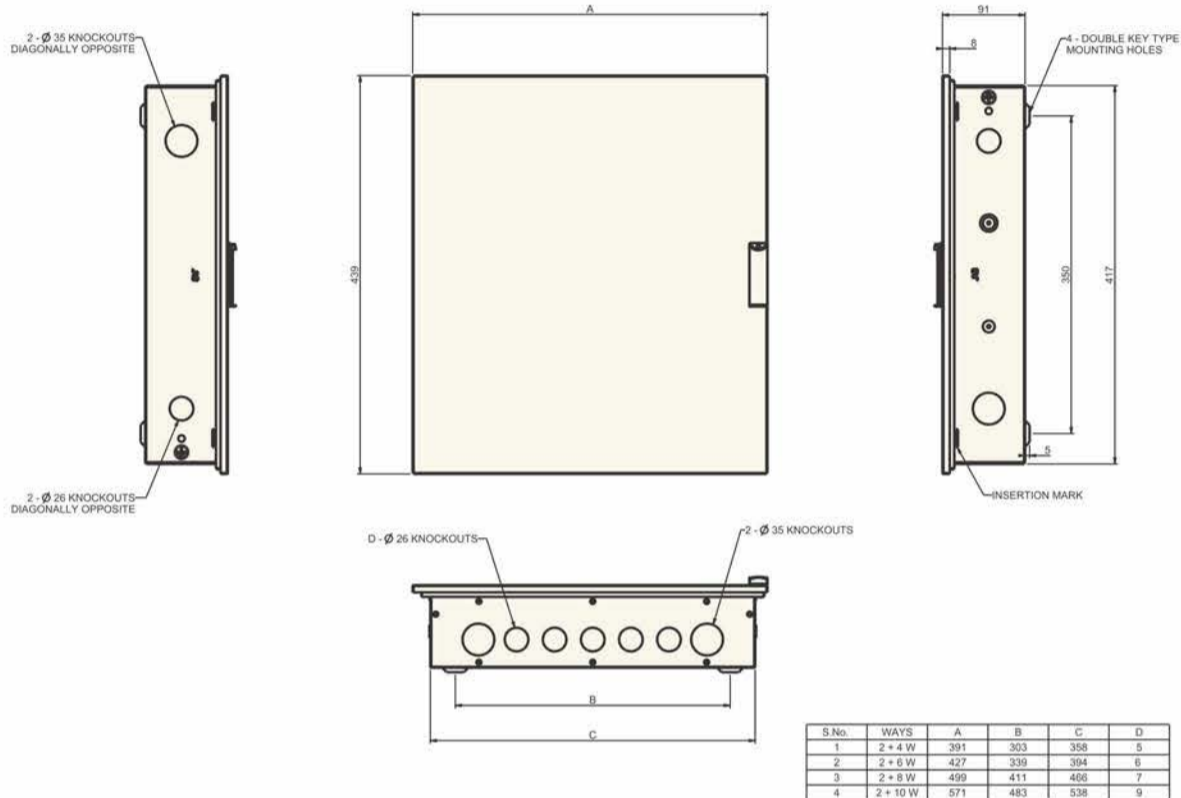

PPI Tier DB Double Door

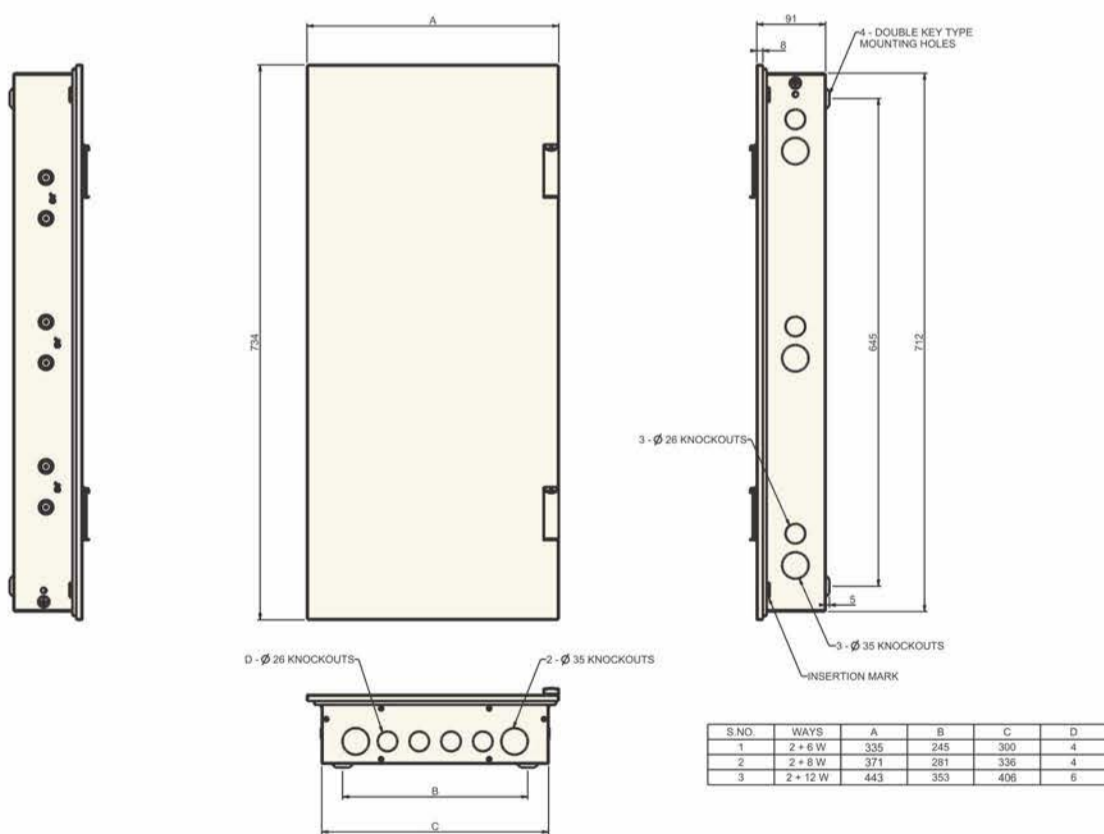

Dimensions

Cable End Box

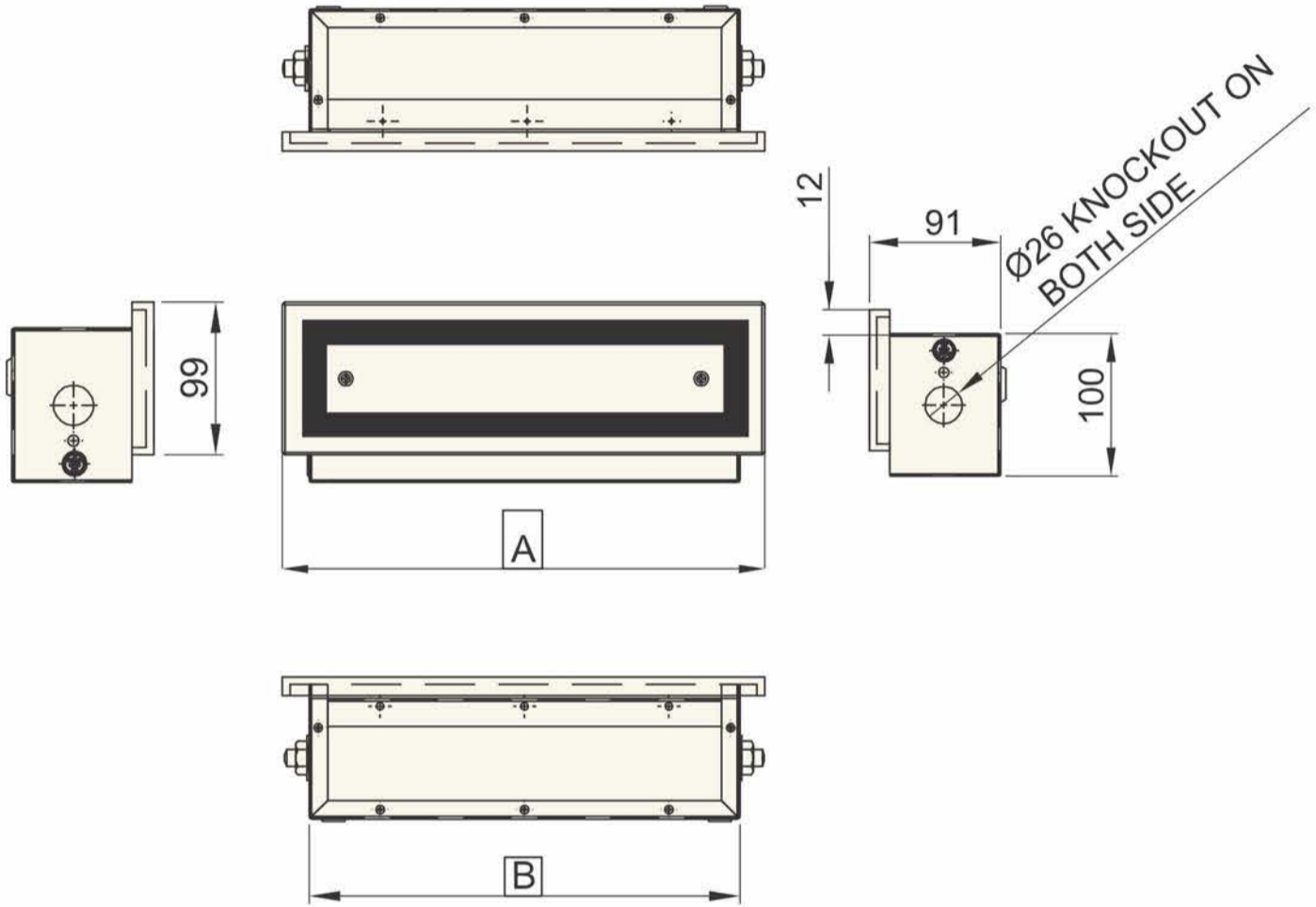

SPN

S.No.	WAYS	A	B
1	4W	168	135
2	6W	204	171
3	8W	240	207
4	12W	312	279
5	16W	384	351

TPN/PPI HRZN

S.No.	WAYS	INCOMER	A	B
1	4W	4P	283	250
2	4W	8P	355	322
3	6W	4P	355	322
4	6W	8P	391	358
5	8W	8P	427	394
6	10W	8P	499	466
7	12W	8P	571	538

VTPN

S.No.	WAYS	A	B	C
1	4W	435	400	111

FLEXY

S.No.	WAYS	A	B
1	8W	335	300
2	28W	443	408
3	42W	443	408
4	56W	443	408

PPI TIER

S.No.	WAYS	A	B
1	6W	335	251
2	8W	371	287
3	12W	443	359

Dimensions

MCCB Enclosure

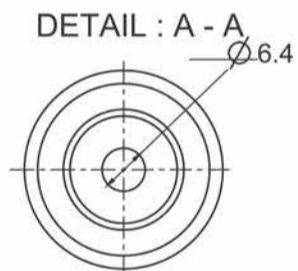
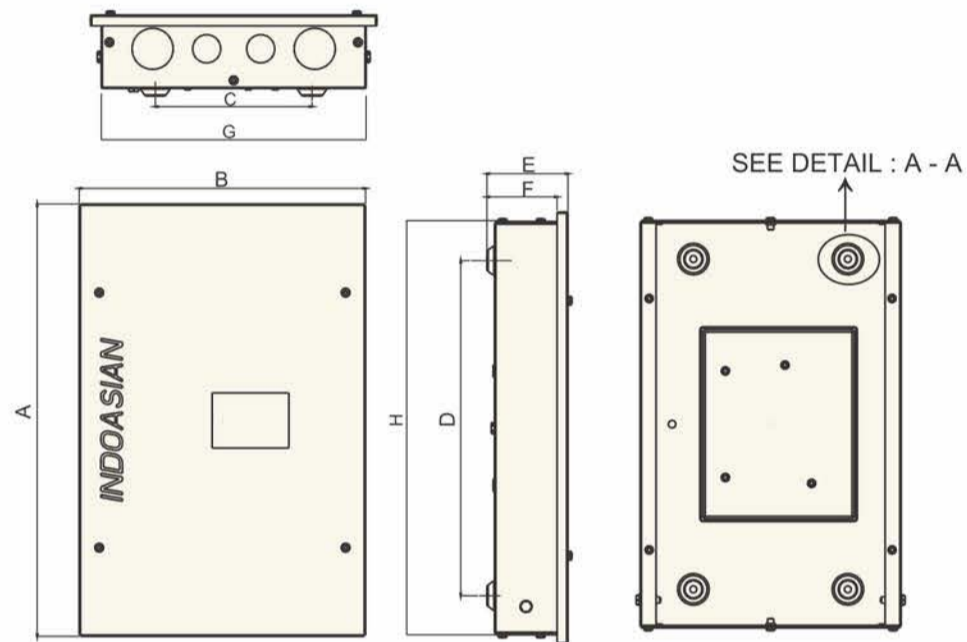

	A	B	C	D	E	F	G	H
811984	400	265	145	310	75	68	245	382.4
811985	400	265	145	310	75	68	245	382.4
811986	420	340	220	330	75	68	320	402.4
811987	420	340	220	330	75	68	320	402.4
811988	420	340	220	330	101	94	320	402.4
811989	420	340	220	330	101	94	320	402.4
811990	720	470	350	630	135	128	450	702.4
811991	720	470	350	630	135	128	450	702.4

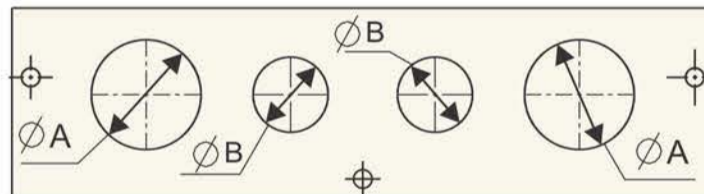

S.NO.		KNOCKOUT Ø A	KNOCKOUT Ø B
1.	811984 / 811985	38	26
2.	811986 / 811987	38	38
3.	811988 / 811989	52	38
4.	811990 / 811991	60	60



— optipro™ —

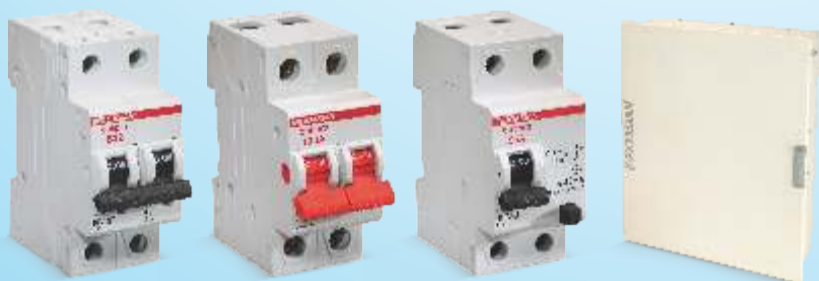

ALL THAT YOU NEED

Presenting Optipro. The complete range of protection & distribution devices for electrical systems, from the house of Indo Asian. Please approach the Indo Asian counter to discover more.

INDOASIAN 
MAKES SENSE

SPN DB-Single door

- IP : 30 Protection
- Door Earthing
- Isolated Neutral Bar
- Mechanical Impact Strength Ik08
- Cement Spill Protector

Ways	Modules	Cat. Nos.
4	4	811800
6	6	811801
8	8	811802
12	12	811803
16	16	811804

SPN DB-Double door

- IP : 43 Protection
- Door Earthing
- Isolated Neutral Bar
- Mechanical Impact Strength Ik08
- Cement Spill Protector

Ways	Modules	Cat. Nos.
4	4	811805
6	6	811806
8	8	811807
12	12	811808
16	16	811809

SPN DB-Acrylic door

- IP : 43 Protection
- Cement Spill Protector
- Isolated Neutral Bar
- Door Earthing

Ways	Modules	Cat. Nos.
4	4	811816
6	6	811817
8	8	811818
12	12	811819
16	16	811820

TPN DB-Single door

- IP : 30 Protection
- Door Earthing
- Isolated Neutral Bar
- Mechanical Impact Strength Ik08
- Cement Spill Protector

Ways	Modules	Cat. Nos.
4 Way compact	4+12	811832
4 Way	8+12	811833
6 Way compact	4+18	811834
6 Way	8+18	811835
8 Way	8+24	811836
12 Way	8+36	811837

TPN DB-Double door

- IP : 43 Protection
- Door Earthing
- Isolated Neutral Bar
- Mechanical Impact Strength Ik08
- Cement Spill Protector

Ways	Modules	Cat. Nos.
4 Way compact	4+12	811840
4 Way	8+12	811841
6 Way compact	4+18	811842
6 Way	8+18	811843
8 Way	8+24	811844
12 Way	8+36	811845
16 Way	8+48	811846

TPN DB-Acrylic door

- IP : 43 Protection
- Cement Spill Protector
- Isolated Neutral Bar
- Door Earthing

Ways	Modules	Cat. Nos.
4 Way compact	4+12	811848
4 Way	8+12	811849
6 Way compact	4+18	811850
6 Way	8+18	811851
8 Way	8+24	811852
12 Way	8+36	811853
16 Way	8+48	811854

VTPN MCB DB-Single door

- IP : 30 Protection
- Door Earthing
- Isolated Neutral Bar
- Mechanical Impact Strength Ik08
- Insulated busbar assembly

Ways	Modules	Cat. Nos.
4 Way	8+12	811864
6 Way	8+18	811865
8 Way	8+24	811866
12 Way	8+36	811867

VTPN MCB DB-Double door

- IP : 43 Protection
- Door Earthing
- Isolated Neutral Bar
- Mechanical Impact Strength Ik08
- Insulated busbar assembly

Ways	Modules	Cat. Nos.
4 Way	8+12	811870
6 Way	8+18	811871
8 Way	8+24	811872
12 Way	8+36	811873

VTPN MCCB 125A DB-Double door

- IP : 43 Protection
- Door Earthing
- Isolated Neutral Bar
- Mechanical Impact Strength Ik08
- Insulated busbar assembly

Ways	Modules	Cat. Nos.
4 Way	Optium F1+12	811888
6 Way	Optium F1+18	811889
8 Way	Optium F1+24	811890
12 Way	Optium F1+36	811891

VTPN MCCB 250A DB-Double door

- IP : 43 Protection
- Door Earthing
- Isolated Neutral Bar
- Mechanical Impact Strength Ik08
- Insulated busbar assembly

Ways	Modules	Cat. Nos.
4 Way	Optium F2+12	811893
6 Way	Optium F2+18	811894
8 Way	Optium F2+24	811895
12 Way	Optium F2+36	811896

Flexi DB-Double door

- IP : 43 Protection
- Door Earthing
- Isolated Neutral Bar
- Mechanical Impact Strength Ik08
- Cement Spill Protector

Ways	Modules	Cat. Nos.
14 X 2 Row	28	811912
14 X 3 Row	42	811913
14 X 4 Row	56	811915

7 Segment DB-Double door

- IP : 43 Protection
- Door Earthing
- Isolated Neutral Bar
- Mechanical Impact Strength Ik08
- Compartmentalized solution

Ways	Modules	Cat. Nos.
4 Way	8+12+12	811925
6 Way	8+12+18	811926
8 Way	8+12+24	811927
12 Way	8+12+36	811928

Phase selector DB 40A Double door

- IP : 43 Protection
- Door Earthing
- 40 A prefitted selector switch
- Mechanical Impact Strength Ik08
- Isolated Neutral Bar

Ways	Modules	Cat. Nos.
4 Way	4+12	811940
6 Way	4+18	811941
8 Way	8+24	811942
12 Way	8+36	811943

Phase selector DB 63A Double door

- IP : 43 Protection
- Door Earthing
- 63 A prefitted selector switch
- Mechanical Impact Strength Ik08
- Isolated Neutral Bar

Ways	Modules	Cat. Nos.
4 Way	4+12	811950
6 Way	4+18	811951
8 Way	8+24	811952
12 Way	8+36	811953

Metal clad P&S

- IP : 30 Protection
- Without MCBs
- Mechanical Impact Strength Ik08

Ways	Modules	Cat. Nos.
20A 2P+E	1 Mod	811955
20A 2P+E	2 Mod	811956
20A 3P+E	3 Mod	811957
32A 3P+E	3 Mod	811958

Plastic P&S

- IP : 30 Protection
- Without MCBs

	Ways	Modules	Cat. Nos.
	16A 2P+E	2 Mod	811959
	32A 2P+E	2 Mod	811960
	32A 3P+N+E	4 Mod	811961
	63A 3P+N+E	4 Mod	811962

Enclosures

	Ways	Modules	Cat. Nos.
	1/2 Mod plastic	2	811977
	3/4 Mod plastic	4	811978
	1 Mod metal	1	811979
	2 Mod metal	2	811980
	3 Mod metal	3	811981
	4 Mod metal	4	811982

TV/TEL DB

- IP : 43 Protection
- Isolated Neutral Bar & Shrouded Bus Bar
- Mechanical Impact Strength Ik08
- Factory fitted KRONE type TV & TEL socket
- Door Earthing

	Ways	Modules	Cat. Nos.
	8 Way SPN	8	811963
	12 Way SPN	12	811964
	4 Way TPN	8+12	811967
	6 Way TPN	8+18	811983
	8 Way TPN	8+24	811968

PPI DB

- IP : 43 Protection
- Door Earthing
- Isolated Neutral Bar for individual phase
- Mechanical Impact Strength Ik08
- Cement Spill Protector

	Ways	Modules	Cat. Nos.
	Hori 4+2 Way	8+6+12	811971
	Hori 6+2 Way	8+6+18	811972
	Hori 8+2 Way	8+6+24	811973
	Tier 6+2 Way	8+6+18	811974
	Tier 8+2 Way	8+6+24	811975
	Tier 12+2 Way	8+6+36	811976

CABLE END BOX

- IP : 43 Protection
- Mechanical Impact Strength IK08

	Description	Cat. Nos.
	SPN DD 4 Way DB	812000
	SPN DD 6 Way DB	812001
	SPN DD 8 Way DB	812002
	SPN DD 12 Way DB	812004
	SPN DD 16 Way DB	812005
	TPN DD 4 Way 4 Pole I/c DB	812006
	TPN DD 4 Way 8 Pole I/c DB	812007
	TPN DD 6 Way 4 Pole I/c DB	812008
	TPN DD 6 Way 8 Pole I/c DB	812009
	TPN DD 8 Way DB	812010
	TPN DD 12 Way DB	812012
	TPN DD 16 Way DB	812013
	VTPN MCB I/c DB	812014
	Flexy DD 8x4 Way DB	812015
	Flexy DD 14x2 Way DB	812016
	PPI Horizontal DD DB 4+2W	812017
	PPI Horizontal DD DB 6+2W	812018
	PPI Horizontal DD DB 8+2W	812019
	PPI Tier DD DB 6+2W	812020
	PPI Tier DD DB 8+2W	812021
	PPI Tier DD DB 12+2W	812022
	VTPN MCCB I/C DD DB	812023

MCCB ENCLOSURE

- IP : 30 Protection
- Solid Neutral Link for 3 Pole MCCBs

	Description	Cat. Nos.
	Optipro Enclosure for Frame-1 Optium 3 Pole MCCB	811984
	Optipro Enclosure for Frame-1 Optium 4 Pole MCCB	811985
	Optipro Enclosure for Frame-2 Optium 3 Pole MCCB	811986
	Optipro Enclosure for Frame-2 Optium 4 Pole MCCB	811987
	Optipro Enclosure for Frame-3 Optium 3 Pole MCCB	811988
	Optipro Enclosure for Frame-3 Optium 4 Pole MCCB	811989
	Optipro Enclosure for Frame-4 Optium 3 Pole MCCB	811990
	Optipro Enclosure for Frame-4 Optium 4 Pole MCCB	811991

CORPORATE OFFICE:

V. J. Business Towers, A-6, 1st Floor, Sector-125, Noida-201301, U.P., India. Ph.: +91-0120-3305100
E-mail: sales@indoasian.com, international@indoasian.com Website: www.indoasian.com

CUSTOMER SUPPORT EXECUTIVE:

V. J. Business Towers, A-6, 1st Floor, Sector-125, Noida-201301, U.P., India.
Ph.: +91-0120-3305111 E-mail: feedback@indoasian.com

NORTH**Regional Sales office**

DELHI NCR
V. J. Business Towers
A-6, Ground Floor,
Sector-125, Noida-201301
Ph.: 0120-3365300
E-Mail: in-delhi-office@indoasian.com

Branch offices

CHANDIGARH
S.C.O.-11, 2nd Floor,
Sector-26, Madhya Marg,
Chandigarh-160002
Ph.: 0172-3934651
E-Mail: in-chandigarh-office@indoasian.com

Branch offices

JAIPUR
433, 4th Floor, Ganpati Plaza,
M. I. Road,
Jaipur-302001
Ph.: 0141-4113528
E-Mail: in-jaipur-office@indoasian.com

Branch offices

LUCKNOW
301, 3rd Floor, Chintel House,
Station Road,
Lucknow-226001
Ph.: 0522-4013210
E-Mail: in-lucknow-office@indoasian.com

SOUTH**Regional Sales office**

BANGALORE
787, 1st Floor "Skyline Vista"
15th Cross, 100 Feet Ring Road
J P Nagar 1st Phase
Bangalore-560 078
Tel: 080-46219999
E-Mail: in-bangalore-office@indoasian.com

Branch offices

COCHIN
Door No.65/1317, Syda Building,
2nd Floor, Kaloor-Kadavanthra Road,
Kaloor, Ernakulam District,
Kochi-682017 (Kerala)
Ph.: 0484-4055581-88
E-Mail: in-cochin-office@indoasian.com

Branch offices

COIMBATORE
Door No. 83,
Dr. Nanjappa Road,
Coimbatore-641018
Ph.: 0422-2302715
E-Mail: in-coimbatore-office@indoasian.com

Branch offices

CHENNAI
No.5, 1st Floor, Mahalingapuram Main Road,
Nungambakkam,
Chennai-600034
Ph.: 044-28172096, 28170527
E-Mail: in-chennai-office@indoasian.com

Branch offices

HYDERABAD
312, 3rd Floor,
Amrutha Estates, Himayath Nagar,
Hyderabad-500029
Ph.: 040-66742425
E-Mail: in-secunderabad-office@indoasian.com

WEST**Regional Sales office**

MUMBAI
401 & 408, K.P. Arrum,
Marol Morshi Road, Andheri East,
Mumbai-400059
Ph.: 022-61035800
E-Mail: in-mumbai-office@indoasian.com

Branch offices

AHMEDABAD
102, 1st Floor, Shivalik High Street,
Near Mansi Circle, Vastrapur,
Ahmedabad-380015
Ph.: 079-29701351-53
E-Mail: in-ahmedabad-office@indoasian.com

Branch offices

INDORE
202, KK Bafna Arcade,
Janjeerwala Square, Race Course Road,
Indore-452001
Ph.: 0731-4064064
E-Mail: in-indore-office@indoasian.com

Branch offices

PUNE
1307, 4th Floor, Rajadwar Building,
Off. J. M. Road, Shivaji Nagar,
Pune-411005
Ph.: 020-60500440
E-Mail: in-pune-office@indoasian.com

EAST**Regional Sales office**

KOLKATA
"Raikva Building" Room No. 8, 2nd Floor,
3A Ram Mohan Garden Lane,
Beliaghata E.M.Bypass, Kolkata-700010
Ph.: 033-66041503
E-Mail: in-kolkata-office@indoasian.com

