



3RW55/55F



3RW52



3RW50



3RW30

3RW40

## contents

Introduction	7/2 – 7/3
<b>SIRIUS 3RW soft starters</b>	
General data	7/4 – 7/11
<b>High Performance soft starters</b>	
3RW55 soft starters	
- General Data	7/12 – 7/25
- Inline circuit	7/26 – 7/29
- Inside-delta circuit	7/30 – 7/33
- Accessories	7/34 – 7/35
<b>3RW55 Failsafe soft starters <span style="color: orange;">NEW</span></b>	
- General Data	7/36 – 7/48
- Inline circuit	7/49
- Inside-delta circuit	7/50
- Accessories	7/51 – 7/52
<b>General Performance soft starters</b>	
3RW52 soft starters	
- General Data	7/53 – 7/64
- Inline circuit	7/65 – 7/66
- Inside-delta circuit	7/67 – 7/68
- Accessories	7/69 – 7/70
<b>Basic Performance soft starters</b>	
<b>3RW50 soft starters <span style="color: orange;">NEW</span></b>	
- General Data	7/71 – 7/79
- Inline circuit	7/80
- Accessories	7/81 – 7/82
3RW40 soft starters	
- General Data	7/83 – 7/89
- Inline circuit	7/90 – 7/91
- Accessories	7/92 – 7/93
3RW30 soft starters	
- General Data	7/94 – 7/101
- Inline circuit	7/102
- Accessories	7/103 – 7/104
<b>Soft Starter Software</b>	7/105
<b>Spare parts</b>	
For 3RW55/3RW55 Failsafe <span style="color: orange;">NEW</span>	7/105 – 7/107
For 3RW52	7/108 – 7/109
For 3RW50 <span style="color: orange;">NEW</span>	7/110
<b>Class 73/74 Enclosed Softstarter applications</b>	
Overview	7/111
Application	7/111
Selection and ordering data	7/112 - 7/123
Factory Modifications	7/124
Dimensional drawings	7/125
Schematics	7/126
<b>SINAMICS G120X Drives</b>	
Introduction, Technical and General data	7/127 - 7/129
Selection and ordering data	7/130 - 7/132
Kits, options, features	7/133

Introduction

Overview

More information

Homepage, see [www.usa.siemens.com/soft-starter](http://www.usa.siemens.com/soft-starter)  
 Industry Mall, see [www.siemens.com/product?3RW](http://www.siemens.com/product?3RW)  
 TIA Selection Tool Cloud (TST Cloud), see <https://www.siemens.com/tstcloud/?node=Sirius3rwFolder>

Industry Online Support (SIOS) topic page, see <https://support.industry.siemens.com/cs/ww/en/view/109747404>  
 Simulation Tool for Soft Starters (STS), see page 6/8 or <https://support.industry.siemens.com/cs/ww/en/view/101494917>



3RW55



3RW55 Failsafe



3RW52



3RW50



3RW40



3RW30

Page

3RW soft starters

High Performance soft starters

3RW55 soft starters

- TIA integration optional
- Plug-in communication modules for PROFINET, PROFIBUS, EtherNet/IP and Modbus
- Removable HMI module with color display, local interface and slot for a micro SD memory card
- Extended protection functions
- Up to 1000HP @ 480V (600V and 690V ratings also available)
- Automatic parameterization for simple commissioning and reliability even under changing load conditions
- Hybrid switching devices for minimum power loss and three-phase motor control for optimum/symmetrical motor control
- Pump stop for reduced mechanical loading and optimum pump stop control
- ATEX/IECEX certification

7/12

3RW55 Failsafe soft starters

- TIA integration optional
- Plug-in communication modules for PROFINET, PROFIBUS, EtherNet/IP and Modbus
- Removable HMI module with color display, local interface and slot for a micro SD memory card
- Extended protection functions
- Up to 400HP @ 480V
- SIL 1 - PL c / STO without additional components
- SIL 3 - PL e / STO with additional contactor and safety relay
- Hybrid switching devices for minimum power loss and three-phase motor control for optimum/symmetrical motor control
- Pump stop for reduced mechanical loading and optimum pump stop control
- ATEX/IECEX certification

7/36

General Performance soft starters

3RW52 soft starters

- TIA integration optional
- Plug-in communication modules for PROFINET, PROFIBUS, EtherNet/IP and Modbus
- HMI modules optional
- Soft starting and stopping
- Current limiting
- Motor overload protection (optionally with thermistor motor protection)
- Analog output (optional)
- Up to 400HP @ 480V (600V ratings also available)
- Hybrid switching devices for minimum power loss and three-phase motor control for optimum/symmetrical motor control
- Soft Torque for reduced mechanical loading and optimum pump stop
- Parameterization using potentiometers

7/53

Introduction



3RW55



3RW55 Failsafe



3RW52



3RW50



3RW40



3RW30

Page

3RW soft starters

**Basic Performance soft starters**

**3RW50 soft starters**

- TIA integration optional
- Communication modules for PROFINET, PROFIBUS, EtherNet/IP and Modbus
- HMI modules optional
- Soft starting and stopping
- Current limiting
- Motor overload protection (optionally with thermistor motor protection)
- Analog output (optional)
- Up to 400HP @ 480V (600V ratings also available)
- Hybrid switching devices for minimum power loss and two-phase motor control
- Soft Torque for reduced mechanical loading and optimum pump stop
- Parameterization using potentiometers
- ATEX/IECEx certification

7/71

**3RW40 soft starters**

- Soft starting and stopping
- Current limiting
- Motor overload protection (optionally with thermistor motor protection)
- Up to 75HP @ 480V 600V ratings also available)
- Hybrid switching devices for minimum power loss and two-phase motor control
- ATEX certification

7/83

**3RW30 soft starters**

- Soft starting with voltage ramp
- Up to 75HP @ 480V

7/94

For enclosed applications

**Enclosures in NEMA 1, 3, 4, & 12 types UL/CSA listed**

- Complete starter includes 3RW40 or 3RW44 and CPT
- Performance Range of up to 600 Hp (at 460 V)
- Combination options include circuit breaker or fusible disconnect
- Application areas:
  - Compressors
  - Pumps
  - Stamping presses
  - Cooling towers
  - Molding and extruding
  - Chippers and debarkers
- Lumber processing
- Pulp & paper processing
- Conveyors
- Textiles
- HVAC

7/111

**Use of soft starters in conjunction with IE3/IE4 motors**

Note:

For the use of SIRIUS 3RW soft starters in conjunction with highly energy-efficient IE3/IE4 motors, please observe the information on dimensioning and configuring, [see Application Manual](#).

# SIRIUS 3RW Soft Starters

## General data

### Overview

#### More information

Homepage, see [www.usa.siemens.com/soft-starter](http://www.usa.siemens.com/soft-starter)  
 Industry Mall, see [www.siemens.com/product?3RW](http://www.siemens.com/product?3RW)  
 TIA Selection Tool Cloud (TST Cloud), see <https://www.siemens.com/tstcloud/?node=Sirius3rwFolder>

Industry Online Support (SIOS) topic page, see <https://support.industry.siemens.com/cs/ww/en/view/109747404>  
 Simulation Tool for Soft Starters (STS), see page 7/7 or <https://support.industry.siemens.com/cs/ww/en/view/101494917>

### SIRIUS 3RW soft starters – as versatile as your application

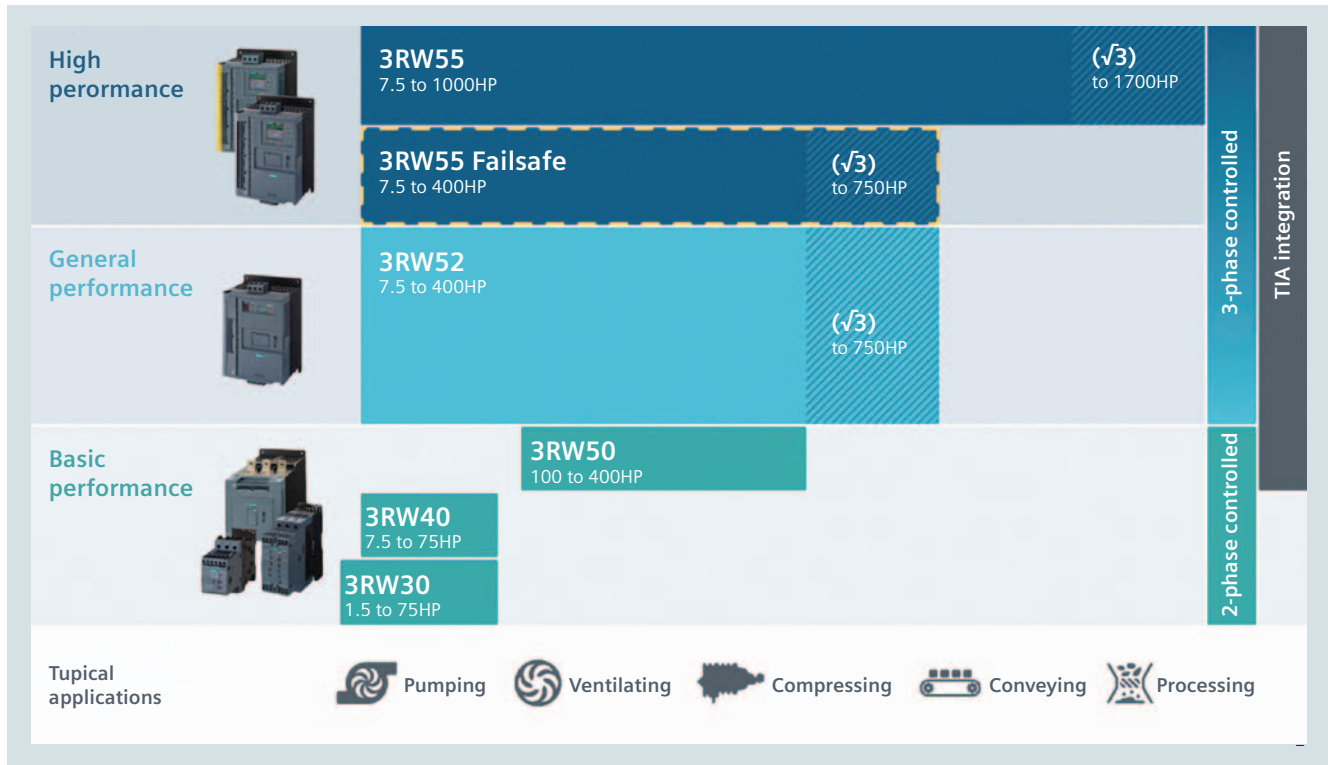

# SIRIUS 3RW Soft Starters

## General data



Applications	High Performance	General Performance	Basic Performance		
SIRIUS soft starters	3RW55/3RW55-F	3RW52	3RW50	3RW40	3RW30

### Selection aid for soft starters

#### Normal starting (CLASS 10)

Pumps	●	●	●	●	●
Pumps with special pump stop (to prevent water hammer)	●	○	○		
Heat pumps	●	●	●	●	●
Hydraulic pumps	●	●	●	●	○
Presses	●	●	●	●	○
Conveyor belts	●	●	●	●	○
Roller conveyors	●	●	●	●	○
Screw conveyors	●	●	●	●	○
Escalators	●	●	●	●	
Piston compressors	●	●	●	●	
Screw compressors	●	●	●	●	
Small fans <sup>1)</sup>	●	●	●	●	
Centrifugal blowers	●	●	●	●	
Bow thrusters	●	●	●	●	

#### Heavy starting (CLASS 20)

Stirrers	●	○	○	○	
Extruders	●	○	○	○	
Lathes	●	○	○	○	
Milling machines	●	○	○	○	

#### Heavy starting (CLASS 30)

Large fans <sup>2)</sup>	●				
Circular saws/bandsaws	●				
Centrifuges	●				
Mills	●				
Crushers	●				

- Recommended soft starter
- Possible soft starter

1) The mass inertia of the fan is <10 times the mass inertia of the motor.  
 2) The mass inertia of the fan is ≥10 times the mass inertia of the motor.



Applications		High Performance		General Performance	Basic Performance		
SIRIUS soft starters		3RW55	3RW55-F	3RW52	3RW50	3RW40	3RW30
<b>General technical specifications</b>							
Operational current at 40 °C	A	13 ... 2 217	13 ... 987	13 ... 987	143 ... 570	12.5 ... 106	3 ... 106
Operational voltage	V	200 ... 690 <sup>1)</sup>	200 ... 480	200 ... 600	200 ... 600	200 ... 600	200 ... 480
<b>Operating power for three-phase motors</b>							
• At 400 V, at 40 °C	- Inline circuit	kW	5.5 ... 710	5.5 ... 315	5.5 ... 315	75 ... 315	5.5 ... 55
	- Inside-delta circuit	kW	11 ... 1 200	11 ... 560	11 ... 560	--	--
• At 460/480 V at 50 °C	- Inline circuit	hp	7.5 ... 1 000	7.5 ... 400	7.5 ... 400	100 ... 400	7.5 ... 75
	- Inside-delta circuit	hp	10 ... 1 700	10 ... 750	10 ... 750	--	--
Ambient temperature <sup>2)</sup>	°C	-25 ... +60	-25 ... +60	-25 ... +60	-25 ... +60	-25 ... +60	-25 ... +60
Soft starting/ramp-down		✓	✓	✓	✓	✓	✓ <sup>3)</sup>
Voltage ramp		✓	✓	✓	✓	✓	✓
Starting voltage	%	20 ... 100	20 ... 100	30 ... 100	30 ... 100	40 ... 100	40 ... 100
Ramp-up and ramp-down time	s	0 ... 360	0 ... 360	0 ... 20	0 ... 20	0 ... 20	0 ... 20 <sup>3)</sup>
Pump stop (torque control) <sup>4)</sup>		✓	✓	--	--	--	--
• Starting torque	%	10 ... 100	10 ... 100	--	--	--	--
• Torque limit	%	20 ... 200	20 ... 200	--	--	--	--
Soft Torque (torque limit)		--	--	✓	✓	--	--
Integral bypass contact system		✓	✓	✓	✓	✓	✓
Intrinsic device protection		✓	✓	✓	✓	✓	--
Motor overload protection		✓ <sup>5)</sup>	✓ <sup>5)</sup>	✓	✓ <sup>5)</sup>	✓ <sup>5)</sup>	--
Thermistor motor protection evaluation		✓	✓	✓ <sup>6)</sup>	✓ <sup>6)</sup>	✓ <sup>6)</sup>	--
Analog output		✓	✓	✓ <sup>6)</sup>	✓ <sup>6)</sup>	--	--
Remote RESET		✓	✓	✓	✓	✓	--
Adjustable current limiting		✓	✓	✓	✓	✓	--
Inside-delta circuit <sup>1)</sup>		✓	✓	✓	--	--	--
Breakaway pulse		✓	✓	--	--	--	--
Automatic parameterization		✓	✓	--	--	--	--
Pump cleaning		✓	✓	--	--	--	--
Condition monitoring		✓	✓	--	--	--	--
User account administration <sup>8)</sup>		✓	✓	--	--	--	--
Creep speed in both directions of rotation		✓	--	--	--	--	--
Reversing duty		✓	✓	--	--	--	--
Reversing DC braking <sup>4)7)</sup>		✓	--	--	--	--	--
DC braking <sup>4)7)</sup>		✓	--	--	--	--	--
Dynamic DC braking <sup>4)7)</sup>		✓	--	--	--	--	--
Motor heating		✓	--	--	--	--	--
Communication function <sup>9)</sup>		✓	✓	✓	✓	--	--
HMI module installable in the cabinet door		✓	✓	✓ <sup>9)</sup>	✓ <sup>9)</sup>	--	--
Operating measured value display		✓	✓	✓ <sup>9)</sup>	✓ <sup>9)</sup>	--	--
Logbooks		✓	✓	✓ <sup>9)</sup>	✓ <sup>9)</sup>	--	--
Statistical data and slave pointer function		✓	✓	✓ <sup>9)</sup>	✓ <sup>9)</sup>	--	--
Trace function <sup>8)</sup>		✓	✓	--	--	--	--
Programmable control inputs and outputs		✓	✓	--	--	--	--
Number of parameter sets		3	3	1	1	1	1
Parameterizable via software <sup>8)</sup>		✓	✓	--	--	--	--
Number of controlled phases		3	3	3	2	2	2
Heavy starting CLASS 30 <sup>4)</sup>		✓	✓	--	--	--	--

✓ Function available  
-- Function not available

<sup>1)</sup> Inside-delta circuit only up to operational voltage 600 V.

<sup>2)</sup> Note derating above 40 °C.

<sup>3)</sup> Only soft starting available for 3RW30.

<sup>4)</sup> Calculate soft starter and motor with size allowance where required.

<sup>5)</sup> When using the motor overload protection according to ATEX/IECEx, an upstream contactor may be required, [see page 7/10](#).

<sup>6)</sup> Special device versions only.

<sup>7)</sup> Not possible in inside-delta circuit.

<sup>8)</sup> With software Soft Starter ES (TIA Portal).

<sup>9)</sup> Only in conjunction with special accessories.

# SIRIUS 3RW Soft Starters

## General data

### Constraints

The 3RW soft starters should always be designed on the basis of the required rated operational current of the motor.

The motor ratings listed in the selection and ordering data are rough guide values and designed for basic starting conditions (CLASS 10). For other starting conditions we recommend the Simulation Tool for Soft Starters (STS).

Motor rating data in kW and hp is based on IEC 60947-4-1.

At an installation altitude above 2 000 m, max. permissible operational voltage is reduced to 480 V.

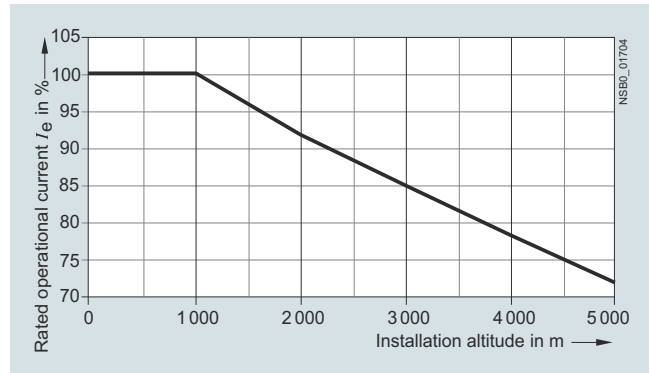

Installation altitude for SIRIUS 3RW soft starters

The selection and ordering data were determined for the following constraints (stand-alone installation without auxiliary fan)



Applications		High Performance	General Performance	Basic Performance		
SIRIUS soft starters		3RW55/3RW55-F	3RW52	3RW50	3RW40	3RW30
<b>Constraints</b>						
Maximum starting time	s	20	10			3
Maximum starting current in % of motor current	$I_e$	300				
Maximum number of starts per hour	1/h	5				20

### Simulation Tool for Soft Starters (STS)

The Simulation Tool for Soft Starters (STS) provides a convenient means of designing soft starters using a simple, quick and easy-to-use interface.

Entering the motor and load data will simulate the application and prompt suggestions for suitable soft starters.

Link to the free download of the [Simulation Tool for Soft Starters \(STS\)](#).

- Simple, quick and user-friendly interface
- Detailed and up-to-date Siemens motor database, including IE3/IE4 motors.
- Simulation of heavy starting up to CLASS 30
- Update-capable (e.g. motors, load types, functions)
- Fast simulations with minimum input data
- Immediate, graphical curve charts of start operations with limit values
- Table view of suitable soft starters for the application



Everything at a glance: Simulation and results list

## SIRIUS 3RW Soft Starters

## General data

**Circuit concept**

Three-phase controlled SIRIUS 3RW soft starters can be operated in two different types of circuit:

- **Inline circuit**  
The controls for isolating and protecting the motor are simply connected in series with the soft starter. The motor is connected to the soft starter with three leads.
- **Inside-delta circuit**  
The wiring is similar to that of wye-delta starters. The phases of the soft starter are connected in series with the individual motor windings. The soft starter then only has to carry the phase current, amounting to about 58% of the rated motor current (conductor current).

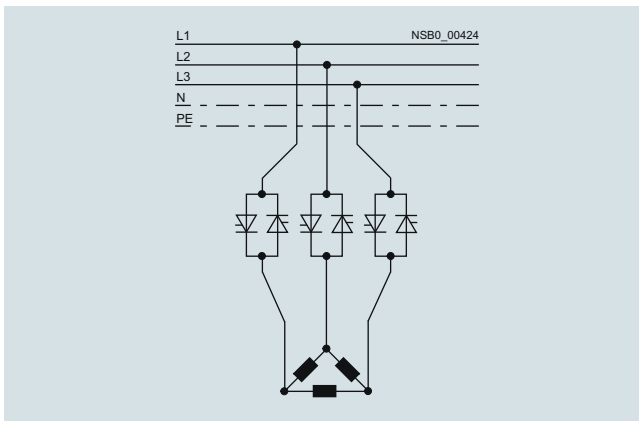
Comparison of the types of circuit

Inline circuit: Rated current  $I_e$  corresponds to the rated motor current  $I_n$ , three cables to the motor

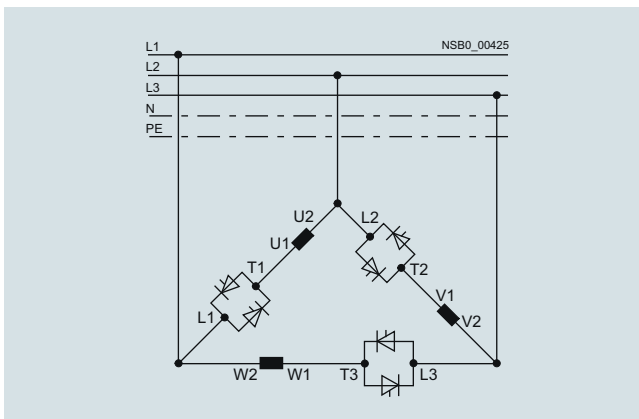

Inside-delta circuit: Rated current  $I_e$  corresponds to approx. 58% of the rated motor current  $I_n$ , six cables to the motor (as for wye-delta starters)

Which circuit?

Using the inline circuit involves the lowest wiring outlay. If the soft starter to motor connections are long, this circuit is preferable.

The wiring complexity is twice as high when using the inside-delta circuit, but a smaller device can be used with the same rating. Thanks to the choice of operating mode between the inline circuit and inside-delta circuit, it is always possible to select the most favorable solution.

The braking function is possible only in the inline circuit. The inside-delta circuit cannot be used in 690 V line supplies.

**Configuration**

The solid-state 3RW soft starters are designed for normal starting. In case of heavy starting or increased starting frequency, a larger unit must be selected. The 3RW52 soft starters may be used in isolated supply networks (IT systems) up to 600 V AC and the 3RW55 soft starters even up to 690 V.

For long starting times it is recommended to have a PTC sensor or temperature switch in the motor. This also applies for the ramp-down modes torque control, pump stop and DC braking, because during the ramp-down time in these modes, an additional current loading applies in contrast to free ramp-down.

No capacitive elements are permitted in the motor feeder between the SIRIUS 3RW soft starter and the motor (e.g. no reactive-power compensation equipment). In addition, neither static systems for reactive-power compensation nor dynamic PFC (Power Factor Correction) must be operated in parallel during starting and ramp-down of the soft starter. This is important to prevent faults arising on the compensation equipment and/or the soft starter.

All elements of the main circuit (such as fuses and controls) should be dimensioned for direct-on-line starting, following the local short-circuit conditions. Fuses and switching devices must be ordered separately. The harmonic component load for starting currents must be taken into consideration for the selection of motor starter protectors (selection of release). Please observe the maximum switching frequencies specified in the technical specifications.

Notes:

When three-phase motors are switched on, voltage drops occur as a rule on starters of all types (direct-on-line starters, wye-delta starters, soft starters). The infeed transformer must always be dimensioned such that the voltage dip when starting the motor remains within the permissible tolerance. If the infeed transformer is dimensioned with only a small margin, it is best for the control voltage to be supplied from a separate circuit (independently of the main voltage) in order to avoid the potential switching off of the soft starter.

For dimensioning soft starters, we recommend our Simulation Tool for Soft Starters (STS), see page 7/7 or our Technical Support: <https://support.industry.siemens.com/My/ww/en/requests>.

Recommended parameters for the initial commissioning of our SIRIUS 3RW soft starters are listed in every report of our Simulation Tool for Soft Starters (STS). In addition, our High Performance soft starters provide support by means of their commissioning wizards.



**Motor feeders with soft starters**

The type of coordination according to which the motor feeder with soft starter is mounted depends on the application-specific requirements. Normally, fuseless mounting (combination of motor starter protector and soft starter) is sufficient.

If type of coordination "2" is to be fulfilled, then semiconductor fuses must be fitted in the motor feeder.

T<sub>OC</sub> 1

Type of coordination "1" according to IEC 60947-4-1: After a short-circuit incident, the unit is defective and therefore unsuitable for further use (protection of persons and system guaranteed).

T<sub>OC</sub> 2

Type of coordination "2" according to IEC 60947-4-1: After a short-circuit incident the unit is suitable for further use (protection of persons and system guaranteed).

The type of coordination refers to soft starters in combination with the stipulated protective device (motor starter protector/fuse), not to any additional components in the feeder.

The types of coordination are indicated in the corresponding tables by the symbols shown on orange backgrounds.

**Feeder tests and events**

To keep the scope of feeder tests with SIRIUS 3RW soft starters within economically reasonable limits, tests were conducted with feeder components (motor starter protectors/circuit breakers, fuses) that cover the greatest number of use cases (different soft starter versions depending on, for example, line voltage, type of circuit, or necessary overdimensioning). For the combined tests that were conducted, the values for the short-circuit breaking capacity  $I_q$  in kA were determined and documented.

If the short-circuit breaking capacity is the same, of course, smaller circuit breakers or fuses can also be used for the selected soft starter provided the dimensioning of the short-circuit components is suitable for the connected three-phase motor and the line protection for the cables used. For type of coordination "2" (with semiconductor protection), it is also necessary to compare the characteristics because the protection function would no longer be completely ensured if too small a fuse were selected. If the soft starter does not have a motor protection function, the motor protection must also be dimensioned appropriately.

**Setting the motor current**

If circuit breakers with an overload release are used (e.g. SIRIUS 3RV20 motor starter protector), we recommend activating the motor protection function of the SIRIUS 3RW soft starter to protect the motor and setting the soft starter to the rated operational current  $I_e$  of the motor. We recommend setting the circuit breaker in such a way that it provides line protection but does not usually trip before the soft starter when a motor overload occurs.

**Line protection and motor protection**

Line protection and motor protection are not ensured in all operating cases, depending on:

- How the motor feeder is constructed (e.g. with fuses or motor starter protectors)
- Whether the SIRIUS 3RW soft starters are operated within the specification relevant for the tests (IEC 60947-4-2)
- Or whether the documented constraints (see page 7/7) have been observed.

There are operating states of the thyristors (caused, for example, by high starting frequencies or heavy starting) that do not permit an overload to be disconnected by the SIRIUS 3RW soft starter. These cases are very rare but can not be ruled out in all cases.

In accordance with IEC 60947-4-2, the SIRIUS 3RW soft starters are dimensioned and checked for operation with up to 8 times the rated operational current  $I_e$ . For currents larger than this, reliable disconnection of an overcurrent by the SIRIUS 3RW soft starter is not ensured. Such large overcurrents have to be disconnected by a switching device at a higher level (e.g. by a circuit breaker or a fuse in conjunction with an optional line contactor).

Motor protection by the SIRIUS 3RW soft starter is ensured for currents up to 8 times the rated operational current  $I_e$  in any case. Line protection is covered by the line-side motor starter protector/circuit breaker or fuse. These motor feeder components must be dimensioned accordingly and the cable cross-sections must be chosen to match.

**Line protection**

Line protection in motor feeders with soft starters is always covered by a fuse or a circuit breaker both in case of an overload and in case of a short circuit. The circuit breaker must have an overload release. That is the case for motor starter protectors (e.g. SIRIUS 3RV20).

Circuit breakers without an overload release (e.g. SIRIUS 3RV23 motor starter protectors) must not be used because they do not provide overload protection. The feeder tests for these were therefore not performed. If the motor feeder with SIRIUS 3RW soft starters is configured without a fuse, motor starter protectors must be used that ensure tripping on an overload.

**Motor protection**

If fuses are used to provide protection against overload and short circuit of the cables, the motor is protected by the SIRIUS 3RW soft starter. If the constraints (simple starting conditions CLASS 10, listed maximum values for starting current, starting time and number of starts per hour) of page 7/7 are observed, the motor feeders can be configured according to IEC as described in the section about soft starters (an optional line contactor is not required). If these preconditions are met, the SIRIUS 3RW soft starters are able to trip on overloads to protect the motor in any case.

In other starting conditions and on heavy starting, the following must be considered:

**Trip classes**

Tested fuseless switchgear assemblies comprising SIRIUS 3RW soft starters and motor starter protectors only comply with CLASS 10.

To configure tested motor feeders, for example, for CLASS 20 or CLASS 30, fuses must be used together with SIRIUS 3RW soft starters.

**Line contactor**

In applications with high starting frequencies or heavy starting as of CLASS 20, we recommend combining fuses with the use of a line contactor on the line side so that a motor overload is disconnected by the fault signaling contact of the soft starter in any case (that is, even in rare cases in which disconnection by the SIRIUS 3RW soft starter is no longer possible due to the operating state of the thyristors).

# SIRIUS 3RW Soft Starters

## General data

### ATEX/IECEx-certified motor overload protection

#### Ambient temperature during operation

The SIRIUS 3RW soft starters are approved for operation in a temperature range of -25 to +60 °C.

Please take into account derating of the rated operational current for ambient temperatures above 40 °C.

For more information, see [Equipment Manual and the technical data sheet of the selected soft starter](#).

#### Trip class (electronic overload protection)

The motor and cables must be dimensioned for the selected trip class.

The rated data of the soft starters refers to normal starting (CLASS 10). For heavy starting (> CLASS 10), the soft starter may need to be oversized as only a rated motor current that is lower than the soft starter rated current can be set.

#### Short-circuit protection

The SIRIUS 3RW soft starter does not have short-circuit protection. Short-circuit protection must be ensured.

#### Line protection

Avoid impermissibly high cable surface temperatures by correctly dimensioning the cross-sections.

The cable cross-section must be adequately dimensioned.

#### Line contactor or additional undervoltage release on the motor starter protector

In many ATEX/IECEx applications no additional measures (e.g. the use of a line contactor) are necessary with regard to the motor feeder configuration.

The operation of the selected soft starter may, depending on the amplitude of the line voltage and the type of motor connection (inline circuit or inside-delta circuit), result in the loss of the certified motor overload protection according to ATEX/IECEx if one of the two remedial measures listed below is not implemented.

#### Remedial measures

- An additional line contactor in the main circuit
- An additional undervoltage release for a motor feeder configuration with a motor starter protector

The line contactor or the undervoltage release are connected to error outputs 95, 96 and 98 of the selected soft starter

#### Note:

For ATEX/IECEx applications, the accompanying information on parameterization and commissioning must be observed in the ATEX/IECEx chapters of the [Equipment Manual](#) for the selected soft starter.

### Article No. scheme

Product versions	Article number									
Device type	<b>High Performance soft starters</b>	<b>3RW55</b>	<input type="checkbox"/>	<input type="checkbox"/>	-	<input type="checkbox"/>	<input type="checkbox"/>	<input type="checkbox"/>	<input type="checkbox"/>	<input type="checkbox"/>
	<b>General Performance soft starters</b>	<b>3RW52</b>	<input type="checkbox"/>	<input type="checkbox"/>	-	<input type="checkbox"/>	<input type="checkbox"/>	<input type="checkbox"/>	<input type="checkbox"/>	<input type="checkbox"/>
	<b>Basic Performance soft starters</b>	<b>3RW50</b>	<input type="checkbox"/>	<input type="checkbox"/>	-	<input type="checkbox"/>	<input type="checkbox"/>	<input type="checkbox"/>	<input type="checkbox"/>	<input type="checkbox"/>
		<b>3RW40</b>	<input type="checkbox"/>	<input type="checkbox"/>	-	<input type="checkbox"/>	<input type="checkbox"/>	<input type="checkbox"/>	<input type="checkbox"/>	<input type="checkbox"/>
<b>3RW30</b>		<input type="checkbox"/>	<input type="checkbox"/>	-	<input type="checkbox"/>	<input type="checkbox"/>	<input type="checkbox"/>	<input type="checkbox"/>	<input type="checkbox"/>	
Size/rated operational current $I_e$	e.g. 15 = 25 A in size S1		<input type="checkbox"/>	<input type="checkbox"/>						
Connection type	e.g. 1 = screw terminal					<input type="checkbox"/>				
Soft starter functionality	e.g. AC = with bypass and analog output, three-phase controlled						<input type="checkbox"/>	<input type="checkbox"/>		
Rated control supply voltage $U_s$	e.g. 0 = 24 V AC/DC							<input type="checkbox"/>		
Rated operational voltage $U_e$	e.g. 4 = 200 ... 480 V AC								<input type="checkbox"/>	
Example		<b>3RW52</b>	<b>1</b>	<b>5</b>	<b>-</b>	<b>1</b>	<b>A</b>	<b>C</b>	<b>0</b>	<b>4</b>

#### Note:

The Article No. scheme shows an overview of product versions for better understanding of the logic behind the article numbers.

For your orders please use the article numbers quoted in the selection and ordering data.

## Benefits

### Can be flexibly deployed in many applications

**Strong portfolio:**  
comprehensive, coordinated soft starter portfolio

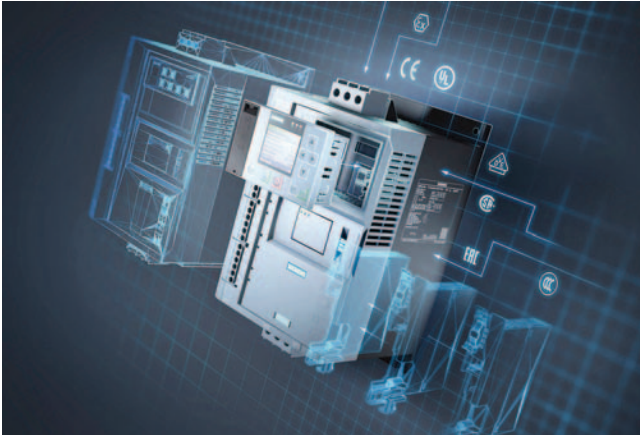

- The right hardware for all requirements, soft starters for tasks ranging from simple to demanding starting in Basic, General and High Performance versions
- Extensive portfolio for individual expansion: Optional HMIs for installation in the device or mounting on the control cabinet door
- Communication via PROFINET, PROFIBUS, EtherNet/IP and Modbus
- Design enclosure with removable terminals, space-saving thanks to compact design and rugged thanks to coated printed circuit boards
- Can be used worldwide thanks to numerous certificates and approvals: IEC, UL, CSA, CCC, ATEX/IECEX, shipbuilding

**Intelligent operation:**  
concentrated, application-specific functionality



- Can be used in a wide variety of applications: Pumping, ventilating, compressing, moving and processing
- Integrated, self-learning automatic parameterization depending on motor starting conditions
- Application-specific functionality such as pump cleaning and pump stop
- Condition monitoring: Current and power monitoring with warning and alarm limits, starting time monitoring

**Efficient switching:**  
hybrid switching technology on board

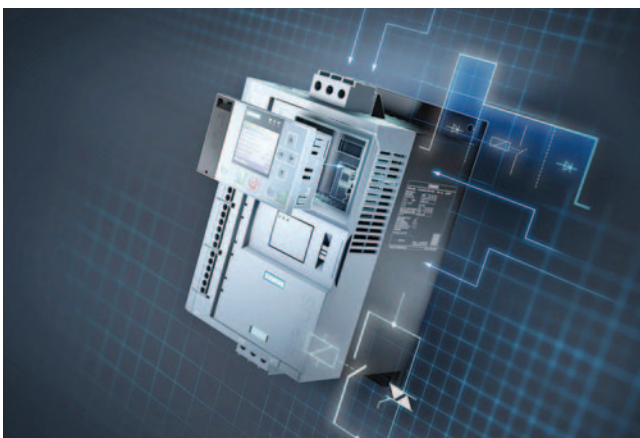

- Energy-efficient switching and mechanical protection of the drive train thanks to soft starters with hybrid switching technology
- Low-wear switching extends the service life of the devices
- Soft starting prevents current peaks, thereby increasing the network stability
- Protection against disturbances in the application. Mechanical protection for the drive train

**Ready for a digital future:**  
data available whenever and wherever needed

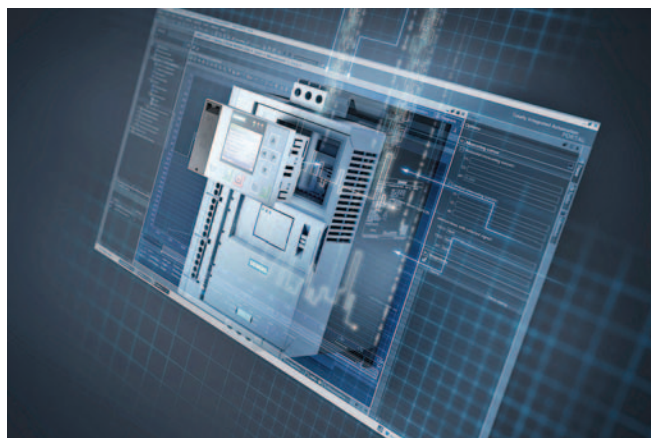

- Support from tools and data during engineering
- Simulation Tool for Soft Starters for support during product selection
- Very simple, standardized commissioning and configuration via Soft Starter ES in TIA Portal
- Integration in the automation system via communication interfaces
- Data availability and analysis: large volumes of data at any time and anywhere, even into MindSphere

# High Performance Soft Starters

## 3RW55 soft starters > General data

### Overview

#### More information

Homepage, see [www.usa.siemens.com/soft-starter](http://www.usa.siemens.com/soft-starter)  
 Industry Mall, see [www.siemens.com/product?3RW](http://www.siemens.com/product?3RW)  
 TIA Selection Tool Cloud (TST Cloud), see <https://www.siemens.com/tstcloud/?node=Sirius3rwFolder>

Industry Online Support (SIOS) topic page, see <https://support.industry.siemens.com/cs/ww/en/view/109747404>  
 Simulation Tool for Soft Starters (STS), see page 7/7 or <https://support.industry.siemens.com/cs/ww/en/view/101494917>  
 SIRIUS Soft Starter ES (TIA Portal), see page 14/2



Equipped with the utmost functionality, the SIRIUS 3RW55 High Performance soft starters confidently handle even difficult starting and stopping operations. Thanks to innovative torque control, the device can be used for drives with an output of between 7.5 to 1000HP @ 480V.

The functions have been specially designed to offer maximum user friendliness. The HMI (with color display, local interface and a slot for micro SD memory card) and plug-in communication modules (PROFINET, PROFIBUS, EtherNet/IP and Modbus) ensure maximum flexibility. With their modern hybrid switching technology, the SIRIUS 3RW55 soft starters offer efficient switching for long-term, energy-saving use.

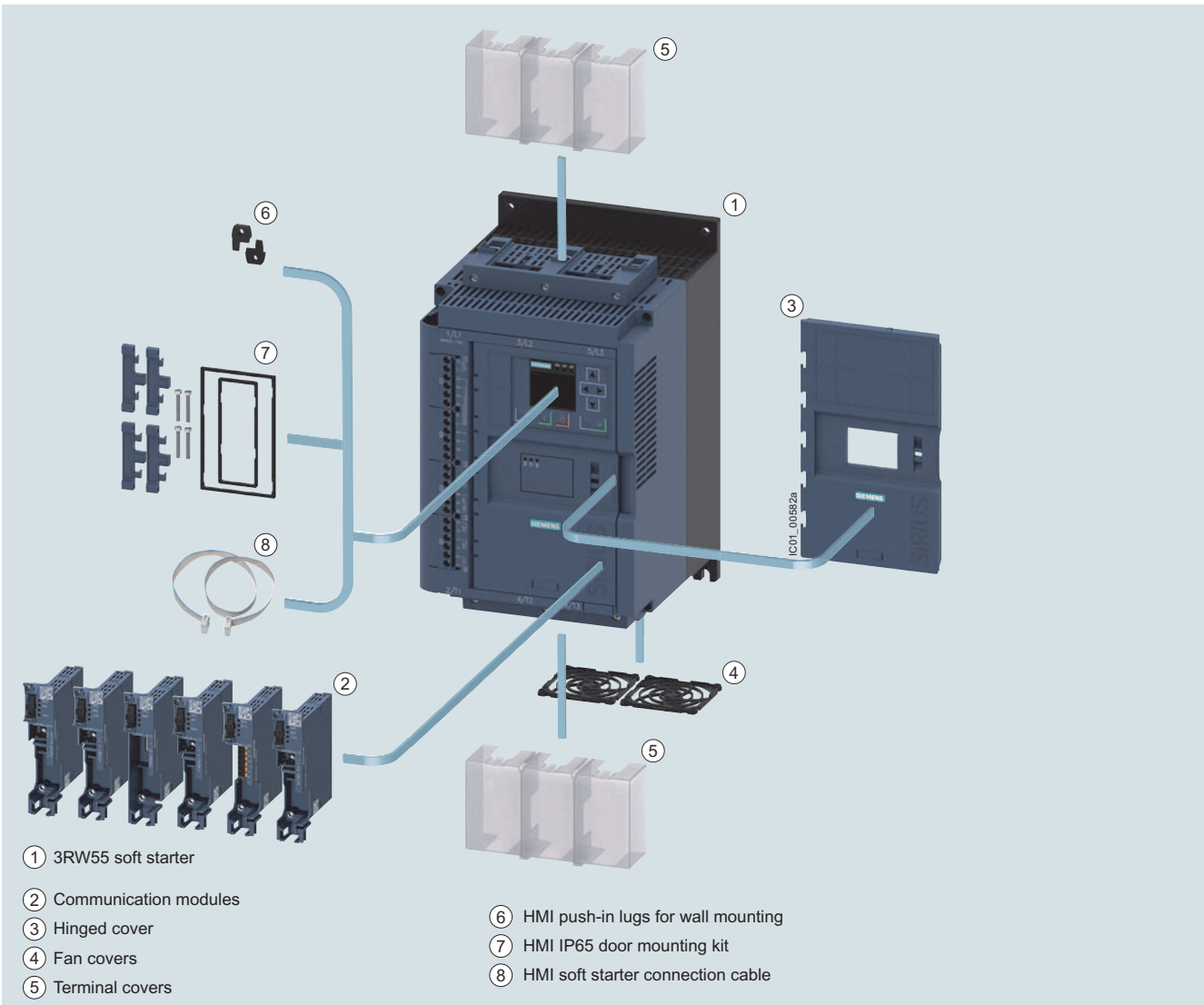

- ① 3RW55 soft starter
- ② Communication modules
- ③ Hinged cover
- ④ Fan covers
- ⑤ Terminal covers
- ⑥ HMI push-in lugs for wall mounting
- ⑦ HMI IP65 door mounting kit
- ⑧ HMI soft starter connection cable

3RW55 High Performance soft starters with accessories, see page 7/35.

## Benefits

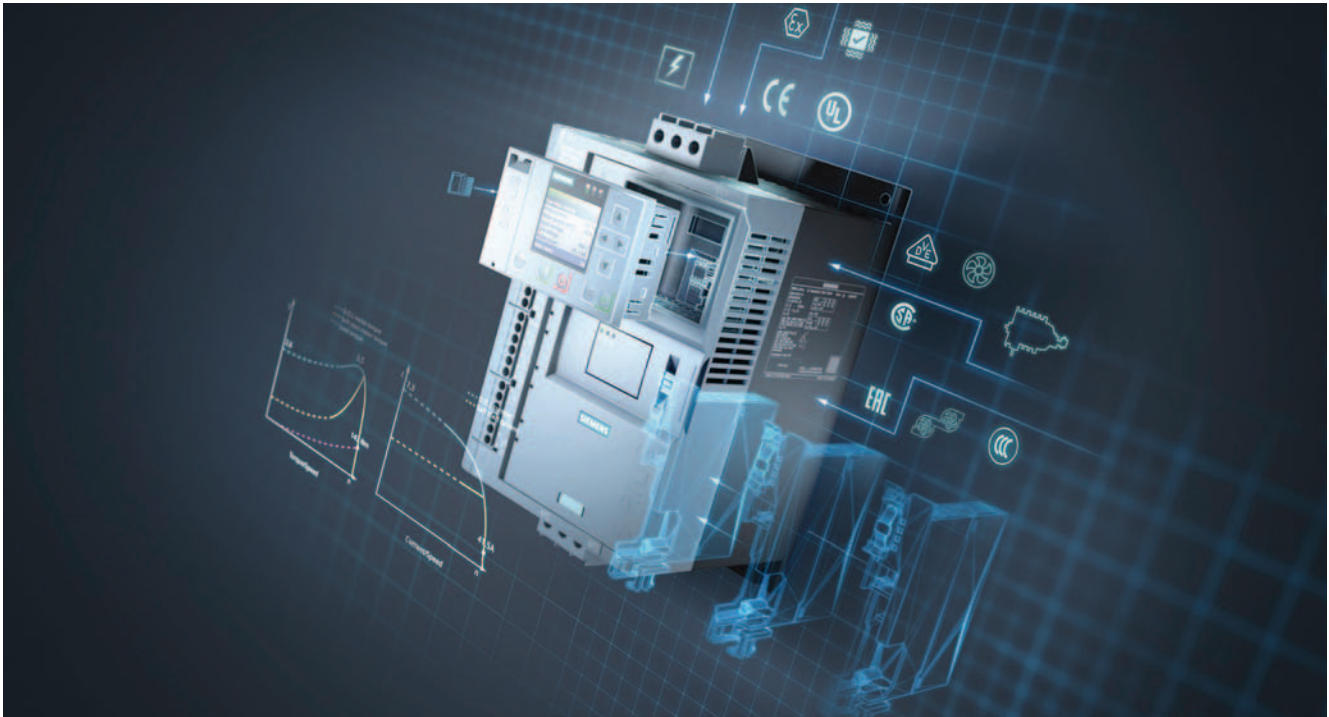

Product characteristics / function	Performance features / benefits
Automatic parameterization	Extremely easy commissioning and reliability even under changing load conditions
Hybrid switching devices and three-phase motor control	Minimum power loss and optimum/symmetrical motor control
Integration into TIA Portal – communication modules optional	Efficient configuration and maximum flexibility in automation engineering
Removable HMI with color display, local interface, slot for micro SD memory card	Maximum flexibility with regard to user interface and intuitive menu guidance
Pump stop and torque control	Reduced mechanical loading and optimum pump stop control
Certified according to ATEX/IECEX directive	Suitable for the starting of explosion-proof motors

## Technical specifications

## More information

Technical specifications, see <https://support.industry.siemens.com/cs/ww/en/ps/25099/td>  
Equipment Manual "SIRIUS 3RW55 Soft Starter", see <https://support.industry.siemens.com/cs/ww/en/view/109753752>

FAQs, see <https://support.industry.siemens.com/cs/ww/en/ps/25099/faq>  
Simulation Tool for Soft Starters (STS), see page 7/7 or <https://support.industry.siemens.com/cs/ww/en/view/101494917>

Type	3RW551.-.HA.4 3RW551.-.HA.5	3RW552.-.HA.6 3RW553.-.HA.6	3RW552.-.HA.4 3RW553.-.HA.4	3RW554.-.HA.4	3RW554.-.HA.6	3RW555.-.HA.4	3RW555.-.HA.6
------	--------------------------------	--------------------------------	--------------------------------	---------------	---------------	---------------	---------------

Installation/fixing/  
dimensions

Width x height x depth	mm	170 x 275 x 152	185 x 306 x 203	210 x 393 x 203	478 x 764 x 241
------------------------	----	-----------------	-----------------	-----------------	-----------------

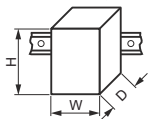

**Type of mounting** Screw fixing

**Mounting position** Vertical (can be rotated +/- 90° and tilted +/- 22.5° forward or backward)

**Distance to be maintained with side-by-side mounting**

- Above mm 100
- At the side mm 5
- Below mm 75

Maximum installation altitude above sea level <sup>1)</sup>	m	5 000	2 000	5 000	2 000	5 000	2 000
---	---	-------	-------	-------	-------	-------	-------

**Degree of protection** IP00

## Ambient conditions

**Ambient temperature**

- During operation<sup>2)</sup> °C -25 ... +60
- During storage and transport °C -40 ... +80

**Environmental category according to IEC 60721**

- During operation 3K6 (no ice formation, no condensation), 3C3 (no salt mist), 3S2 (sand must not get into the devices), 3M6
- During storage 1K6 (only occasional condensation), 1C2 (no salt mist), 1S2 (sand must not enter the devices), 1M4
- During transport 2K2, 2C1, 2S1, 2M2 (max. height of fall 0.3 m)

<sup>1)</sup> Derating from 1 000 m, see [characteristic curve on page 7/7](#).

<sup>2)</sup> Note derating above 40 °C.

Type		3RW55...-HA0.	3RW55...-HA1.
<b>Control circuit/control</b>			
<b>Control supply voltage</b>			
• At AC/DC, rated value	V	24/24	--/--
• At AC	V	--	110 ... 250
• Relative negative tolerance/relative positive tolerance with AC	%	-20/20	-15/10
• Relative negative tolerance/relative positive tolerance with DC	%	-20/20	--/--
<b>Frequency of the control supply voltage</b>			
• Relative negative tolerance/relative positive tolerance	Hz	50 ... 60	
	%	-10/10	
<b>Type of overvoltage protection</b>			
Varistors			
<b>Type of short-circuit protection for control circuit<sup>1)</sup></b>			
Fuse 4 A gG ( $I_{cu} = 1$ kA), fuse 6 A quick-response ( $I_{cu} = 1$ kA), MCB C1 ( $I_{cu} = 600$ A), MCB C6 ( $I_{cu} = 300$ A)			

<sup>1)</sup> Not included in scope of supply

Type		3RW55...-HA.4	3RW55...-HA.5	3RW55...-HA.6
<b>Power electronics</b>				
<b>Operational voltage, rated value</b>				
• Relative negative tolerance/relative positive tolerance	V	200 ... 480	200 ... 600	200 ... 690
	%	-15/10		
<b>Operational voltage for inside-delta circuit, rated value</b>				
• Relative negative tolerance/relative positive tolerance	V	200 ... 480	200 ... 600	
	%	-15/10		
<b>Operating frequency, rated value</b>				
• Relative negative tolerance/relative positive tolerance	Hz	50 ... 60		
	%	-10/10		
<b>Minimum load [% of <math>I_M</math>]<sup>1)</sup></b>				
	%	10		
<b>Maximum cable length between soft starter and motor</b>				
	m	800		

<sup>1)</sup> Relative to set  $I_e$ .

## High Performance Soft Starters

## 3RW55 soft starters &gt; General data

Type		3RW5513	3RW5514	3RW5515	3RW5516	3RW5517
<b>Rated operational current <math>I_e</math></b>	A	13	18	25	32	38
<b>Power electronics</b>						
<b>Load rating with rated operational current <math>I_e</math></b>						
IEC + UL/CSA, individual mounting at 40/50/60 °C, A AC-53a		13/11.5/10.5	18/15.9/13.8	25/22.3/19.6	32/28.4/26	38/33.5/30.5
<b>Permissible rated motor current and starts/h</b>						
<b>Normal starting (CLASS 10A)</b>						
Rated motor current $I_M$ , $T_U = 40/50/60$ °C ON period = 70%; motor protection activated	A	13/11.5/10.5	18/15.9/13.8	25/22.3/19.6	32/28.4/26	38/33.5/30.5
• 300% $I_M$						
- Start-up time 5 s	1/h	43	43	43	43	43
- Start-up time 10 s	1/h	18	18	18	18	18
• 350% $I_M$						
- Start-up time 5 s	1/h	28	28	28	28	28
- Start-up time 10 s	1/h	10	10	10	10	10
<b>Normal starting (CLASS 10E)</b>						
Rated motor current $I_M$ , $T_U = 40/50/60$ °C ON period = 70%; motor protection activated	A	13/11.5/10.5	18/15.9/13.8	25/22.3/19.6	32/28.4/26	38/33.5/30.5
• 300% $I_M$						
- Start-up time 5 s	1/h	21	21	21	21	21
- Start-up time 10 s	1/h	8	8	8	8	8
• 350% $I_M$						
- Start-up time 5 s	1/h	13	13	13	13	13
- Start-up time 10 s	1/h	4	4	4	4	4
<b>Heavy starting (CLASS 20E)</b>						
Rated motor current $I_M$ , $T_U = 40/50/60$ °C ON period = 70%; motor protection activated	A	13/11.5/10.5	18/15.9/13.8	25/22.3/19.6	29.6/27.2/23.6	33.5/30.5/27.5
• 300% $I_M$						
- Start-up time 20 s	1/h	10	10	10	10	10
- Start-up time 40 s	1/h	4	4	4	4	4
• 350% $I_M$						
- Start-up time 20 s	1/h	7	7	7	7	7
- Start-up time 40 s	1/h	2.5	2.5	2.5	2.5	2.5
<b>Heavy starting (CLASS 30E)</b>						
Rated motor current $I_M$ , $T_U = 40/50/60$ °C ON period = 70%; motor protection activated	A	13/11.5/10.5	18/15.9/13.8	25/22.3/19.6	26/23.6/21.2	29/26/23
• 300% $I_M$						
- Start-up time 20 s	1/h	7	7	7	7	7
- Start-up time 40 s	1/h	3	3	3	3	3
• 350% $I_M$						
- Start-up time 20 s	1/h	4	4	4	4	4
- Start-up time 40 s	1/h	1.8	1.8	1.8	1.8	1.8
<b>Adjustable rated motor current <math>I_M</math></b>						
• Minimum/maximum	A	2.5/13	3.5/18	5/25	6.5/32	7.5/38
• Minimum/maximum in inside-delta circuits	A	4.3/22.5	6.1/31.1	8.7/43.3	11.3/55.4	13/65.8



## High Performance Soft Starters

## 3RW55 soft starters &gt; General data

Type		3RW5521	3RW5524	3RW5525	3RW5526	3RW5527
<b>Rated operational current <math>I_e</math></b>	A	25	47	63	77	93
<b>Power electronics</b>						
<b>Load rating with rated operational current <math>I_e</math></b>						
IEC + UL/CSA, individual mounting at 40/50/60 °C, A AC-53a	A	25/22.3/19.6	47/41.6/36.2	63/55.5/50.5	77/68/62	93/82.5/75.5
<b>Permissible rated motor current and starts/h</b>						
<b>Normal starting (CLASS 10A)</b>						
Rated motor current $I_M$ , $T_U = 40/50/60$ °C ON period = 70%; motor protection activated	A	25/22.3/19.6	47/41.6/36.2	63/55.5/50.5	77/68/62	93/82.5/75.5
• 300% $I_M$						
- Start-up time 5 s	1/h	43	43	43	43	43
- Start-up time 10 s	1/h	18	18	18	18	18
• 350% $I_M$						
- Start-up time 5 s	1/h	28	28	28	28	28
- Start-up time 10 s	1/h	10	10	10	10	10
<b>Normal starting (CLASS 10E)</b>						
Rated motor current $I_M$ , $T_U = 40/50/60$ °C ON period = 70%; motor protection activated	A	25/22.3/19.6	47/41.6/36.2	63/55.5/50.5	77/68/62	93/82.5/75.5
• 300% $I_M$						
- Start-up time 5 s	1/h	21	21	21	21	21
- Start-up time 10 s	1/h	8	8	8	8	8
• 350% $I_M$						
- Start-up time 5 s	1/h	13	13	13	13	13
- Start-up time 10 s	1/h	4	4	4	4	4
<b>Heavy starting (CLASS 20E)</b>						
Rated motor current $I_M$ , $T_U = 40/50/60$ °C ON period = 70%; motor protection activated	A	25/22.3/19.6	47/41.6/36.2	63/55.5/50.5	77/68/62	93/82.5/75.5
• 300% $I_M$						
- Start-up time 20 s	1/h	10	10	10	10	10
- Start-up time 40 s	1/h	4	4	4	4	4
• 350% $I_M$						
- Start-up time 20 s	1/h	7	7	7	7	7
- Start-up time 40 s	1/h	2.5	2.5	2.5	2.5	2.5
<b>Heavy starting (CLASS 30E)</b>						
Rated motor current $I_M$ , $T_U = 40/50/60$ °C ON period = 70%; motor protection activated	A	25/22.3/19.6	43.4/38/34.4	53/48/43	68/62/56	82.5/75.5/65
• 300% $I_M$						
- Start-up time 20 s	1/h	7	7	7	7	7
- Start-up time 40 s	1/h	3	3	3	3	3
• 350% $I_M$						
- Start-up time 20 s	1/h	4	4	4	4	4
- Start-up time 40 s	1/h	1.8	1.8	1.8	1.8	1.8
<b>Adjustable rated motor current <math>I_M</math></b>						
• Minimum/maximum	A	5/25	10/47	13/63	16/77	19/93
• Minimum/maximum in inside-delta circuits	A	8.7/43.3	17.3/81.4	22.5/109	27.7/133	32.9/161

## High Performance Soft Starters

## 3RW55 soft starters &gt; General data

Type		3RW5534	3RW5535	3RW5536
<b>Rated operational current <math>I_e</math></b>	A	113	143	171
<b>Power electronics</b>				
<b>Load rating with rated operational current <math>I_e</math></b>				
IEC + UL/CSA, individual mounting at 40/50/60 °C, AC-53a	A	113/101/89	143/128/118	171/153/141
<b>Permissible rated motor current and starts/h</b>				
<b>Normal starting (CLASS 10A)</b>				
Rated motor current $I_M$ , $T_u = 40/50/60$ °C ON period = 70%; motor protection activated	A	113/101/89	143/128/118	171/153/141
• 300% $I_M$				
- Start-up time 5 s	1/h	43	43	43
- Start-up time 10 s	1/h	18	18	18
• 350% $I_M$				
- Start-up time 5 s	1/h	28	28	28
- Start-up time 10 s	1/h	10	10	10
<b>Normal starting (CLASS 10E)</b>				
Rated motor current $I_M$ , $T_u = 40/50/60$ °C ON period = 70%; motor protection activated	A	113/101/89	143/128/118	171/153/141
• 300% $I_M$				
- Start-up time 5 s	1/h	21	21	21
- Start-up time 10 s	1/h	8	8	8
• 350% $I_M$				
- Start-up time 5 s	1/h	13	13	13
- Start-up time 10 s	1/h	4	4	4
<b>Heavy starting (CLASS 20E)</b>				
Rated motor current $I_M$ , $T_u = 40/50/60$ °C ON period = 70%; motor protection activated	A	109/97/85	128/113/103	141/129/117
• 300% $I_M$				
- Start-up time 20 s	1/h	10	10	10
- Start-up time 40 s	1/h	4	4	4
• 350% $I_M$				
- Start-up time 20 s	1/h	7	7	7
- Start-up time 40 s	1/h	2.5	2.5	2.5
<b>Heavy starting (CLASS 30E)</b>				
Rated motor current $I_M$ , $T_u = 40/50/60$ °C ON period = 70%; motor protection activated	A	89/81/74	108/98/88	117/105/93
• 300% $I_M$				
- Start-up time 20 s	1/h	7	7	7
- Start-up time 40 s	1/h	3	3	3
• 350% $I_M$				
- Start-up time 20 s	1/h	4	4	4
- Start-up time 40 s	1/h	1.8	1.8	1.8
<b>Adjustable rated motor current <math>I_M</math></b>				
• Minimum/maximum	A	23/113	29/143	34/171
• Minimum/maximum in inside-delta circuits	A	39.8/195	50.2/247	58.9/296

## High Performance Soft Starters

## 3RW55 soft starters &gt; General data

Type		3RW5543	3RW5544	3RW5545	3RW5546	3RW5547	3RW5548
<b>Rated operational current <math>I_e</math></b>	A	210	250	315	370	470	570
<b>Power electronics</b>							
<b>Load rating with rated operational current <math>I_e</math></b>							
IEC + UL/CSA, individual mounting at 40/50/60 °C, AC-53a	A	210/186/170	250/220/200	315/279/255	370/328/300	470/416/380	570/504/460
<b>Permissible rated motor current and starts/h</b>							
<b>Normal starting (CLASS 10A)</b>							
Rated motor current $I_M$ , $T_u = 40/50/60$ °C ON period = 70%; motor protection activated	A	210/186/170	250/220/200	315/279/255	370/328/300	470/416/380	570/504/460
• 300% $I_M$							
- Start-up time 5 s	1/h	43	43	43	43	40	20
- Start-up time 10 s	1/h	18	18	18	18	17	6
• 350% $I_M$							
- Start-up time 5 s	1/h	28	28	28	28	26	9
- Start-up time 10 s	1/h	10	10	10	10	10	1
<b>Normal starting (CLASS 10E)</b>							
Rated motor current $I_M$ , $T_u = 40/50/60$ °C ON period = 70%; motor protection activated	A	210/186/170	250/220/200	315/279/255	370/328/300	470/416/380	551/490/445
• 300% $I_M$							
- Start-up time 5 s	1/h	21	21	21	21	17	8
- Start-up time 10 s	1/h	8	8	8	8	6	1
• 350% $I_M$							
- Start-up time 5 s	1/h	13	13	13	13	10	2
- Start-up time 10 s	1/h	4	4	4	4	2	--
<b>Heavy starting (CLASS 20E)</b>							
Rated motor current $I_M$ , $T_u = 40/50/60$ °C ON period = 70%; motor protection activated	A	162/146/130	200/180/160	231/207/183	258/230/202	272/254/236	284/262/240
• 300% $I_M$							
- Start-up time 20 s	1/h	10	10	10	10	10	10
- Start-up time 40 s	1/h	4	4	4	4	4	4
• 350% $I_M$							
- Start-up time 20 s	1/h	7	7	7	7	7	7
- Start-up time 40 s	1/h	2.5	2.5	2.5	2.5	2.5	2.5
<b>Heavy starting (CLASS 30E)</b>							
Rated motor current $I_M$ , $T_u = 40/50/60$ °C ON period = 70%; motor protection activated	A	138/122/106	160/140/120	183/159/135	202/174/160	210/190/170	220/200/180
• 300% $I_M$							
- Start-up time 20 s	1/h	7	7	7	7	7	7
- Start-up time 40 s	1/h	3	3	3	3	3	3
• 350% $I_M$							
- Start-up time 20 s	1/h	4	4	4	4	4	4
- Start-up time 40 s	1/h	1.8	1.8	1.8	1.8	1.8	1.8
<b>Adjustable rated motor current <math>I_M</math></b>							
• Minimum/maximum	A	42/210	50/250	63/315	74/370	94/470	114/570
• Minimum/maximum in inside-delta circuits	A	72.7/363	86.6/433	109.1/545	128.2/640	162.8/814	197.5/987

## High Performance Soft Starters

## 3RW55 soft starters &gt; General data

Type		3RW5552	3RW5553	3RW5554	3RW5556	3RW5558
<b>Rated operational current <math>I_e</math></b>	A	630	720	840	1 100	1 280
<b>Power electronics</b>						
<b>Load rating with rated operational current <math>I_e</math></b>						
IEC + UL/CSA, individual mounting at 40/50/60 °C, A AC-53a						
		630/561/510	720/641/580	840/748/670	1 100/979/890	1 280/1 139/1 030
<b>Permissible rated motor current and starts/h</b>						
<b>Normal starting (CLASS 10A)</b>						
Rated motor current $I_M$ , $T_U = 40/50/60$ °C						
ON period = 70%; motor protection activated						
		630/561/510	720/641/580	840/748/670	1 100/979/890	1 280/1 139/1 030
• 300% $I_M$						
- Start-up time 5 s	1/h	43	43	42	43	32
- Start-up time 10 s	1/h	18	18	18	18	12
• 350% $I_M$						
- Start-up time 5 s	1/h	28	28	25	27	17
- Start-up time 10 s	1/h	10	10	10	9	4
<b>Normal starting (CLASS 10E)</b>						
Rated motor current $I_M$ , $T_U = 40/50/60$ °C						
ON period = 70%; motor protection activated						
		630/561/510	720/641/580	840/748/670	1 100/979/890	1 225/1 130/1 030
• 300% $I_M$						
- Start-up time 5 s	1/h	21	21	19	18	15
- Start-up time 10 s	1/h	8	8	7	7	5
• 350% $I_M$						
- Start-up time 5 s	1/h	13	13	10	9	1
- Start-up time 10 s	1/h	4	4	2	2	1
<b>Heavy starting (CLASS 20E)</b>						
Rated motor current $I_M$ , $T_U = 40/50/60$ °C						
ON period = 70%; motor protection activated						
		500/450/400	520/470/420	570/520/470	920/840/760	980/900/810
• 300% $I_M$						
- Start-up time 20 s	1/h	10	10	10	10	10
- Start-up time 40 s	1/h	4	4	4	4	4
• 350% $I_M$						
- Start-up time 20 s	1/h	7	7	7	7	7
- Start-up time 40 s	1/h	2.5	2.5	2.5	2.5	2.5
<b>Heavy starting (CLASS 30E)</b>						
Rated motor current $I_M$ , $T_U = 40/50/60$ °C						
ON period = 70%; motor protection activated						
		380/340/300	400/360/320	420/380/340	740/670/600	790/720/650
• 300% $I_M$						
- Start-up time 20 s	1/h	7	7	7	7	7
- Start-up time 40 s	1/h	3	3	3	3	3
• 350% $I_M$						
- Start-up time 20 s	1/h	4	4	4	4	4
- Start-up time 40 s	1/h	1.8	1.8	1.8	1.8	1.8
<b>Adjustable rated motor current <math>I_M</math></b>						
• Minimum/maximum						
A		114/630	144/720	168/840	220/1 100	258/1 280
• Minimum/maximum in inside-delta circuits						
A		197.5/987	249.4/1 247	291/1 454	381.1/1 905	446.9/2 217

# High Performance Soft Starters

## 3RW55 soft starters > General data

### Motor feeders according to IEC with 3RV2/3VA motor starter protectors/circuit breakers (without semiconductor protection)

Type of coordination "1", CLASS 10, short-circuit breaking capacity  $I_q$  in kA, see table

Note:

For general recommendations for constructing motor feeders with soft starters, see page 7/9.

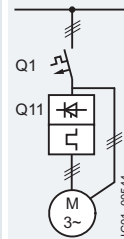
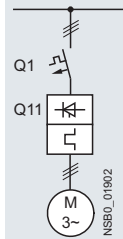

Soft starters	Motor starter protectors for 400 V systems				Motor starter protectors for 500 V systems				
	Q11 Type	Q1 Type	$I_q$ kA	Q1 Type	$I_q$ kA	Q1 Type	$I_q$ kA		
Type of coordination "1" <span style="border: 1px solid black; padding: 2px;">1</span>	Inline circuit				Inside-delta circuit				
3RW5513	3RV2032-4TA10		65	3RV2032-4TA10	18	3RV2032-4DA10	65	3RV2032-4DA10	18
3RW5514	3RV2032-4DA10		65	3RV2032-4DA10	15	3RV2032-4EA10	65	3RV2032-4EA10	15
3RW5515	3RV2032-4EA10		65	3RV2032-4EA10	15	3RV2032-4VA10	65	3RV2032-4VA10	15
3RW5516	3RV2032-4VA10		65	3RV2032-4VA10	10	3RV2032-4JA10	65	3RV2032-4JA10	10
3RW5517	3RV2032-4WA10		65	3RV2032-4WA10	10	3RV2032-4RA10	65	3RV2032-4RA10	10
3RW5521	--		--	--	--	--	--	--	--
3RW5524	3RV2032-4JA10		65	3RV2032-4JA10	10	3RV2032-4RA10	65	3RV2032-4RA10	10
3RW5525	3VA2163-7MN32-0AA0		65	3VA2163-7MN32-0AA0	20	3VA2110-7MN32-0AA0	65	3VA2110-7MN32-0AA0	20
3RW5526	3VA2110-7MN32-0AA0		65	3VA2110-7MN32-0AA0	20	3VA2216-7MN32-0AA0	65	3VA2216-7MN32-0AA0	20
3RW5527	3VA2216-7MN32-0AA0		15	3VA2216-7MN32-0AA0	10	3VA2220-7MN32-0AA0	15	3VA2220-7MN32-0AA0	10
3RW5534	3VA2216-7MN32-0AA0		65	--	--	3VA2220-7MN32-0AA0	65	--	--
3RW5535	3VA2220-7MN32-0AA0		65	--	--	3VA2325-7MN32-0AA0	65	--	--
3RW5536	3VA2325-7MN32-0AA0		30	3VA2325-7MN32-0AA0	10	3VA2440-7MN32-0AA0	30	3VA2440-7MN32-0AA0	10
3RW5543	3VA2325-7MN32-0AA0		65	3VA2325-7MN32-0AA0	65	3VA2440-7MN32-0AA0	65	3VA2440-7MN32-0AA0	65
3RW5544	3VA2440-7MN32-0AA0		65	3VA2440-7MN32-0AA0	65	3VA2450-7MN32-0AA0	65	3VA2450-7MN32-0AA0	65
3RW5545	3VA2440-7MN32-0AA0		65	3VA2440-7MN32-0AA0	65	3VA2580-6HN32-0AA0	65	3VA2580-6HN32-0AA0	65
3RW5546	3VA2440-7MN32-0AA0		65	3VA2440-7MN32-0AA0	65	3VA2580-6HN32-0AA0	65	3VA2580-6HN32-0AA0	65
3RW5547	3VA2450-7MN32-0AA0		65	3VA2450-7MN32-0AA0	65	3VA2510-6HN32-0AA0	65	3VA2510-6HN32-0AA0	65
3RW5548	3VA2580-6HN32-0AA0		65	3VA2580-6HN32-0AA0	65	3VA2510-6HN32-0AA0	65	3VA2510-6HN32-0AA0	65
3RW5552	3VA2580-6HN32-0AA0		65	3VA2580-6HN32-0AA0	65	3VA2716-7AB05-0AA0	65	3VA2716-7AB05-0AA0	65
3RW5553	3VA2510-6HN32-0AA0		65	3VA2510-6HN32-0AA0	65	3VA2716-7AB05-0AA0	65	3VA2716-7AB05-0AA0	65
3RW5554	3VA2510-6HN32-0AA0		65	3VA2510-6HN32-0AA0	65	3VA2716-7AB05-0AA0	65	3VA2716-7AB05-0AA0	65
3RW5556	3VA2716-7AB05-0AA0		65	3VA2716-7AB05-0AA0	65	--	--	--	--
3RW5558	3VA2716-7AB05-0AA0		65	3VA2716-7AB05-0AA0	--	--	--	--	--

Note:

The service factor or measurement inaccuracies have been taken into account, for example, for the selection of the specified motor starter protectors/circuit breakers; the specified short-circuit breaking capacities  $I_q$  in kA are covered by combination tests. Smaller motor starter protectors/circuit breakers than those specified can be used at any time as smaller ones trip more quickly in the event of a short circuit (unchanged short-circuit breaking capacity) and thus protect the soft starter in any case. The dimensioning of the short-circuit components must, however, be suitable for the connected three-phase motor and the line protection for the cables used.

In 690 V systems, in motor feeder tests with soft starters demonstrable short-circuit breaking capacities can only be achieved with the use of fuses ( $I_q > 5$  to 10 kA).

# High Performance Soft Starters

## 3RW55 soft starters > General data

### Motor feeders according to IEC with 3NA3 fuses

gG class full-range fuses for cable and line protection according to IEC 60269-2, without semiconductor protection

Type of coordination "1",  
short-circuit breaking capacity  $I_q = 65 \text{ kA}$

**Note:**

For general recommendations for constructing motor feeders with soft starters, see page 7/9.

Soft starters	gG class fuse		Line contactor (optional)		gG class fuse		Line contactor (optional)		
	for systems up to 690 V		for systems up to 480 V	for systems up to 690 V	for systems up to 480 V in the supply cable	for systems up to 600 V in the supply cable	for systems up to 480 V in the delta	for systems up to 600 V in the delta	
Q11 Type	F1 Type		Q21 Type	Q21 Type	F1 Type		Q21 Type	Q21 Type	
Type of coordination "1"	Inline circuit				Inside-delta circuit				
3RW5513	3NA3820-6		3RT2025	3RT2025	3NA3820-6	3RT2027	3RT2035	3RT2025	3RT2025
3RW5514	3NA3820-6		3RT2026	3RT2027	3NA3820-6	3RT2027	3RT2037	3RT2026	3RT2027
3RW5515	3NA3822-6		3RT2027	3RT2037	3NA3822-6	3RT2036	3RT2037	3RT2027	3RT2037
3RW5516	3NA3824-6		3RT2035	3RT2037	3NA3824-6	3RT2037	3RT2038	3RT2035	3RT2037
3RW5517	3NA3824-6		3RT2035	3RT2037	3NA3824-6	3RT2038	3RT2046	3RT2035	3RT2037
3RW5521	3NA3824-6		3RT2027	3RT2037	3NA3824-6	3RT2036	3RT2037	3RT2027	3RT2037
3RW5524	3NA3824-6		3RT2036	3RT2037	3NA3824-6	3RT2046	3RT2047	3RT2036	3RT2037
3RW5525	3NA3830-6		3RT2037	3RT2046	3NA3830-6	3RT2047	3RT1054	3RT2037	3RT2046
3RW5526	3NA3132-6		3RT2038	3RT2046	3NA3132-6	3RT1055	3RT1055	3RT2038	3RT2046
3RW5527	3NA3136-6		3RT2046	3RT2047	3NA3136-6	3RT1056	3RT1056	3RT2046	3RT2047
3RW5534	3NA3244-6		3RT1054	3RT1054	3NA3244-6	3RT1064	3RT1064	3RT1054	3RT1054
3RW5535	3NA3244-6		3RT1055	3RT1055	3NA3244-6	3RT1065	3RT1065	3RT1055	3RT1055
3RW5536	3NA3365-6		3RT1056	3RT1064	3NA3365-6	3RT1066	3RT1075	3RT1056	3RT1064
3RW5543	2 x 3NA3354-6		3RT1064	3RT1064	2 x 3NA3354-6	3RT1075	3RT1075	3RT1064	3RT1064
3RW5544	2 x 3NA3354-6		3RT1065	3RT1065	2 x 3NA3354-6	3RT1076	3RT1076	3RT1065	3RT1065
3RW5545	2 x 3NA3365-6		3RT1075	3RT1075	2 x 3NA3365-6	3TF68	3TF68	3RT1075	3RT1075
3RW5546	2 x 3NA3365-6		3RT1075	3RT1075	2 x 3NA3365-6	3TF69	3TF69	3RT1075	3RT1075
3RW5547	2 x 3NA3365-6		3RT1076	3RT1276	2 x 3NA3365-6	3TF69	3TF69	3RT1076	3RT1276
3RW5548	2 x 3NA3365-6		3TF68	3TF68	2 x 3NA3365-6	--	--	3TF68	3TF68
3RW5552	2 x 3NA3365-6		3TF68	3TF69	--	--	--	3TF68	3TF69
3RW5553	2 x 3NA3365-6		3TF69	3TF69	--	--	--	3TF69	3TF69
3RW5554	2 x 3NA3365-6		--	--	--	--	--	--	--
3RW5556	3 x 3NA3365-6		--	--	--	--	--	--	--
3RW5558	3 x 3NA3365-6		--	--	--	--	--	--	--

**Note:**

The specified short-circuit breaking capacities  $I_q$  in kA are covered by combination tests. Smaller fuses than those specified can be used at any time as smaller ones trip more quickly in the event of a short circuit (unchanged short-circuit breaking capacity) and thus protect the soft starter in any case. The dimensioning of the short-circuit components must, however, be suitable for the connected three-phase motor and the line protection for the cables used.

In inside-delta circuits, motor feeders with soft starters can only be operated in systems with up to 600 V.

# High Performance Soft Starters

## 3RW55 soft starters > General data

### Motor feeders according to IEC with 3NE1/3NB3 SITOR fuses

gR class full-range fuses for semiconductor protection, cable and line protection

Type of coordination "2",  
short-circuit breaking capacity  $I_q = 65 \text{ kA}$

**Note:**

For general recommendations for constructing motor feeders with soft starters, [see page 7/9](#).

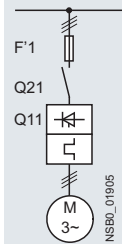

Soft starters	gG class fuse	Line contactor (optional)	
Q11	for systems up to 690 V	for systems up to 480 V	for systems up to 690 V
Type	F'1	Q21	Q21
Type	Type	Type	Type
<b>Type of coordination "2"</b>	<b>Inline circuit</b>		
<b>3RW5513</b>	3NE1815-0	3RT2025	3RT2025
<b>3RW5514</b>	3NE1802-0	3RT2026	3RT2027
<b>3RW5515</b>	3NE1817-0	3RT2027	3RT2037
<b>3RW5516</b>	3NE1818-0	3RT2035	3RT2037
<b>3RW5517</b>	3NE1820-0	3RT2035	3RT2037
<b>3RW5521</b>	3NE1817-0	3RT2027	3RT2037
<b>3RW5524</b>	3NE1021-2	3RT2036	3RT2037
<b>3RW5525</b>	3NE1022-0	3RT2037	3RT2046
<b>3RW5526</b>	3NE1224-0	3RT2038	3RT2046
<b>3RW5527</b>	3NE1224-0	3RT2046	3RT2047
<b>3RW5534</b>	3NE1225-0	3RT1054	3RT1054
<b>3RW5535</b>	3NE1227-0	3RT1055	3RT1055
<b>3RW5536</b>	3NE1230-0	3RT1056	3RT1064
<b>3RW5543</b>	3NE1230-2 <sup>1)</sup>	3RT1064	3RT1064
<b>3RW5544</b>	3NE1331-0	3RT1065	3RT1065
<b>3RW5545</b>	3NE1334-2	3RT1075	3RT1075
<b>3RW5546</b>	3NE1334-2	3RT1075	3RT1075
<b>3RW5547</b>	3NE1436-2	3RT1076	3RT1276
<b>3RW5548</b>	3NE1437-2	3TF68	3TF68
<b>3RW5552</b>	3NB3350-1KK26	3TF68	3TF69
<b>3RW5553</b>	3NB3351-1KK26	3TF69	3TF69
<b>3RW5554</b>	3NB3351-1KK26	--	--
<b>3RW5556</b>	3NB3354-1KK26	--	--
<b>3RW5558</b>	3NB3357-1KK26	--	--

<sup>1)</sup> For systems up to 500 V.

**Note:**

The specified short-circuit breaking capacities  $I_q$  in kA are covered by combination tests. Smaller fuses than those specified can be used at any time as smaller ones trip more quickly in the event of a short circuit (unchanged short-circuit breaking capacity) and thus protect the soft starter in any case. The dimensioning of the short-circuit components must, however, be suitable for the connected three-phase motor and the line protection for the cables used.

In inside-delta circuits, a gR class full-range fuse could not provide the semiconductor protection of the delta-connected soft starter with a short-circuit breaking capacity that is adequate for practical use. In this case, we recommend using aR class partial-range fuses for semiconductor protection for type of coordination "2" ([see page 7/24](#)).

# High Performance Soft Starters

## 3RW55 soft starters > General data

### Motor feeders according to IEC with 3NE8 / 3NE3 / 3NC3 fuses

aR class partial-range fuses for semiconductor protection

Type of coordination "2",  
short-circuit breaking capacity  $I_{q} = 65 \text{ kA}$

**Note:**

For general recommendations for constructing motor feeders with soft starters, [see page 7/9](#).

Soft starters	Inline circuit				Inside-delta circuit						
	gG class fuse	aR class fuse	Line contactor (optional)		gG class fuse	aR class fuse	Line contactor (optional)				
Q11 Type	F1	F3	Q21	Q21	F1	F3	Q21	Q21	Q21	Q21	
Type of coordination "2"	In-line circuit				Inside-delta circuit						
<b>3RW5513</b>	3NA3820-6	3NE8017-1	3RT2025	3RT2025	3NA3820-6	3NE8017-1	3RT2027	3RT2035	3RT2025	3RT2025	
<b>3RW5514</b>	3NA3820-6	3NE8020-1	3RT2026	3RT2027	3NA3820-6	3NE8020-1	3RT2027	3RT2037	3RT2026	3RT2027	
<b>3RW5515</b>	3NA3822-6	3NE8021-1	3RT2027	3RT2037	3NA3822-6	3NE8021-1	3RT2036	3RT2037	3RT2027	3RT2037	
<b>3RW5516</b>	3NA3824-6	3NE8022-1	3RT2035	3RT2037	3NA3824-6	3NE8022-1	3RT2037	3RT2038	3RT2035	3RT2037	
<b>3RW5517</b>	3NA3824-6	3NE8024-1	3RT2035	3RT2037	3NA3824-6	3NE8024-1	3RT2038	3RT2046	3RT2035	3RT2037	
<b>3RW5521</b>	3NA3824-6	3NE8021-1	3RT2027	3RT2037	3NA3824-6	3NE8021-1	3RT2036	3RT2037	3RT2027	3RT2037	
<b>3RW5524</b>	3NA3824-6	3NE8024-1	3RT2036	3RT2037	3NA3824-6	3NE8024-1	3RT2046	3RT2047	3RT2036	3RT2037	
<b>3RW5525</b>	3NA3830-6	3NE3227	3RT2037	3RT2046	3NA3830-6	3NE3227	3RT2047	3RT1054	3RT2037	3RT2046	
<b>3RW5526</b>	3NA3132-6	3NE3227	3RT2038	3RT2046	3NA3132-6	3NE3227	3RT1055	3RT1055	3RT2038	3RT2046	
<b>3RW5527</b>	3NA3136-6	3NE3227	3RT2046	3RT2047	3NA3136-6	3NE3227	3RT1056	3RT1056	3RT2046	3RT2047	
<b>3RW5534</b>	3NA3244-6	3NE3231	3RT1054	3RT1054	3NA3244-6	3NE3231	3RT1064	3RT1064	3RT1054	3RT1054	
<b>3RW5535</b>	3NA3244-6	3NE3233	3RT1055	3RT1055	3NA3244-6	3NE3233	3RT1065	3RT1065	3RT1055	3RT1055	
<b>3RW5536</b>	3NA3365-6	3NE3334-OB	3RT1056	3RT1064	3NA3365-6	3NE3334-OB	3RT1066	3RT1075	3RT1056	3RT1064	
<b>3RW5543</b>	2 x 3NA3354-6	3NE3333	3RT1064	3RT1064	2 x 3NA3354-6	3NE3333	3RT1075	3RT1075	3RT1064	3RT1064	
<b>3RW5544</b>	2 x 3NA3354-6	3NE3335	3RT1065	3RT1065	2 x 3NA3354-6	3NE3335	3RT1076	3RT1076	3RT1065	3RT1065	
<b>3RW5545</b>	2 x 3NA3365-6	--	3RT1075	3RT1075	2 x 3NA3365-6	--	3TF68	3TF68	3RT1075	3RT1075	
<b>3RW5546</b>	2 x 3NA3365-6	--	3RT1075	3RT1075	2 x 3NA3365-6	--	3TF69	3TF69	3RT1075	3RT1075	
<b>3RW5547</b>	2 x 3NA3365-6	3NE3340-8	3RT1076	3RT1276	2 x 3NA3365-6	3NE3340-8	3TF69	3TF69	3RT1076	3RT1276	
<b>3RW5548</b>	2 x 3NA3365-6	3NC3342-1U	3TF68	3TF68	2 x 3NA3365-6	3NC3342-1U	--	--	3TF68	3TF68	
<b>3RW5552</b>	2 x 3NA3365-6	3NC3343-1U	3TF68	3TF69	--	3NC3343-1U	--	--	3TF68	3TF69	
<b>3RW5553</b>	2 x 3NA3365-6	3NC3343-1U	3TF69	3TF69	--	3NC3343-1U	--	--	3TF69	3TF69	
<b>3RW5554</b>	2 x 3NA3365-6	3NC3343-1U	--	--	--	3NC3343-1U	--	--	--	--	
<b>3RW5556</b>	3 x 3NA3365-6	3 x 3NE3340-8	--	--	--	3 x 3NE3340-8	--	--	--	--	
<b>3RW5558</b>	3 x 3NA3365-6	3 x 3NE3340-8	--	--	--	3 x 3NE3340-8	--	--	--	--	

**Note:**

The specified short-circuit breaking capacities  $I_{q}$  in kA are covered by combination tests. Smaller fuses than those specified can be used at any time as smaller ones trip more quickly in the event of a short circuit (unchanged short-circuit breaking capacity) and thus protect the soft starter in any case. The dimensioning of the short-circuit components must, however, be suitable for the connected three-phase motor and the line protection for the cables used.

For CLASS 10 applications, as an alternative to the gG class full-range fuses for cable and line protection 3NA3 (F1), 3RV2/3VA motor starter protectors/circuit breakers can also be used, possibly with reduced short-circuit breaking capacity (see page 7/21). In these cases, optional line contactors can be dispensed with.

In inside-delta circuits, motor feeders with soft starters can only be operated in systems with up to 600 V.



## High Performance Soft Starters

## 3RW55 soft starters &gt; General data

**Reversing operation with reversing contactors**

## Note:

For general recommendations for constructing motor feeders with soft starters, [see page 7/9](#).

(For an example circuit, [see 3RW55 Equipment Manual, Appendix A.3](#))

Soft starters	Reversing contactor assembly		For reversing contactor	
	for systems up to 480 V	for systems up to 690 V	for systems up to 480 V	for systems up to 690 V
Q11	Q21 / Q22	Q21 / Q22	Q21 / Q22	Q21 / Q22
Type	Type	Type	Type	Type
3RW5513	3RA2325	3RA2325	3RT2025	3RT2025
3RW5514	3RA2326	3RA2327	3RT2026	3RT2027
3RW5515	3RA2327	3RA2337	3RT2027	3RT2037
3RW5516	3RA2335	3RA2337	3RT2035	3RT2037
3RW5517	3RA2335	3RA2337	3RT2035	3RT2037
3RW5521	3RA2327	3RA2337	3RT2027	3RT2037
3RW5524	3RA2336	3RA2337	3RT2036	3RT2037
3RW5525	3RA2337	3RA2346	3RT2037	3RT2046
3RW5526	3RA2338	3RA2346	3RT2038	3RT2046
3RW5527	3RA2346	3RA2347	3RT2046	3RT2047
3RW5534	--	--	3RT1054	3RT1054
3RW5535	--	--	3RT1055	3RT1055
3RW5536	--	--	3RT1056	3RT1064
3RW5543	--	--	3RT1064	3RT1064
3RW5544	--	--	3RT1065	3RT1065
3RW5545	--	--	3RT1075	3RT1075
3RW5546	--	--	3RT1075	3RT1075
3RW5547	--	--	3RT1076	3RT1276
3RW5548	--	--	3TF68	3TF68
3RW5552	--	--	3TF68	3TF69
3RW5553	--	--	3TF69	3TF69
3RW5554	--	--	--	--
3RW5556	--	--	--	--
3RW5558	--	--	--	--

**DC braking with braking contactors**

## Note:

For general recommendations for constructing motor feeders with soft starters, [see page 7/9](#).

(For an example circuit, [see 3RW55 Equipment Manual, Appendix A.3](#))

Soft starters	DC braking contactor	DC braking contactor assembly		for systems up to 690 V	
	for systems up to 400 V	for systems up to 480 V		for systems up to 690 V	
Q11	with 2 NC contacts + 2 NO contacts parallel	with 3 NO contacts parallel	with 3 NO contacts parallel	with 3 NO contacts parallel	with 3 NO contacts parallel
Type	Q93	Q91	Q92	Q91	Q92
Type	Type	Type	Type	Type	Type
3RW5513	3RT2517	3RT2015	3RT2016	3RT2015	3RT2016
3RW5514	3RT2518	3RT2015	3RT2017	3RT2015	3RT2023
3RW5515	3RT2526	3RT2015	3RT2025	3RT2015	3RT2025
3RW5516	3RT2526	3RT2015	3RT2025	3RT2015	3RT2027
3RW5517	3RT2535	3RT2015	3RT2027	3RT2015	3RT2027
3RW5521	3RT2526	3RT2015	3RT2025	3RT2015	3RT2025
3RW5524	3RT2535	3RT2016	3RT2027	3RT2016	3RT2035
3RW5525	--	3RT2024	3RT2027	3RT2024	3RT2037
3RW5526	--	3RT2025	3RT2035	3RT2025	3RT2037
3RW5527	--	3RT2027	3RT2036	3RT2027	3RT2037
3RW5534	--	3RT2035	3RT2037	3RT2035	3RT2038
3RW5535	--	3RT2036	3RT2038	3RT2036	3RT2046
3RW5536	--	3RT2037	3RT2046	3RT2037	3RT2047
3RW5543	--	3RT2045	3RT2047	3RT2045	3RT1054
3RW5544	--	3RT2045	3RT1055	3RT2045	3RT1055
3RW5545	--	3RT2446	3RT1056	3RT2446	3RT1056
3RW5546	--	3RT1055	3RT1056	3RT1055	3RT1064
3RW5547	--	3RT1456	3RT1065	3RT1456	3RT1065
3RW5548	--	3RT1456	3RT1066	3RT1456	3RT1075
3RW5552	--	3RT1065	3RT1075	3RT1065	3RT1075
3RW5553	--	3RT1065	3RT1075	3RT1065	3RT1075
3RW5554	--	3RT1466	3RT1076	3RT1466	3RT1076
3RW5556	--	3RT1476	3TF68	3RT1476	3TF68
3RW5558	--	3RT1476	3TF69	3RT1476	3TF69

# High Performance Soft Starters

3RW55 soft starters > Inline circuit **IE3/IE4 ready**

## Selection and ordering data

For normal starting (CLASS 10E)



3RW551.



3RW552.

At 40 °C					At 50 °C					SD <sup>1)</sup>	Article No.	Price per PU	PU (UNIT, SET, M)	PS*
Operational current	Operating power for three-phase motors				Operational current	Rating [hp] for three-phase motors								
	At 230 V	At 400 V	At 500 V	At 690 V		At 200/208 V	At 220/230 V	At 460/480 V	At 575/600 V					
A	kW	kW	kW	kW	A	hp	hp	hp	hp	d				
<b>Operational voltage 200 ... 480 V</b>														
13	3	<b>5.5</b>	--	--	11.5	2	3	<b>7.5</b>	--	5	<b>3RW5513-□HA□4</b>		1	1 unit
18	4	<b>7.5</b>	--	--	15.9	3	5	<b>10</b>	--	5	<b>3RW5514-□HA□4</b>		1	1 unit
25	5.5	<b>11</b>	--	--	22.3	5	7.5	<b>15</b>	--	5	<b>3RW5515-□HA□4</b>		1	1 unit
32	7.5	<b>15</b>	--	--	28.4	7.5	10	<b>20</b>	--	5	<b>3RW5516-□HA□4</b>		1	1 unit
38	11	<b>18.5</b>	--	--	33.5	10	10	<b>20</b>	--	5	<b>3RW5517-□HA□4</b>		1	1 unit
47	11	<b>22</b>	--	--	41.6	10	10	<b>30</b>	--	5	<b>3RW5524-□HA□4</b>		1	1 unit
63	18.5	<b>30</b>	--	--	55.5	15	20	<b>40</b>	--	5	<b>3RW5525-□HA□4</b>		1	1 unit
77	22	<b>37</b>	--	--	68	20	25	<b>50</b>	--	5	<b>3RW5526-□HA□4</b>		1	1 unit
93	22	<b>45</b>	--	--	82.5	25	30	<b>60</b>	--	5	<b>3RW5527-□HA□4</b>		1	1 unit

**Type of electrical connection for the control circuit**

- Screw terminals
- Spring-loaded terminals

**Control supply voltage**

- 24 V AC/DC
- 110 ... 250 V AC

<sup>1)</sup> 3RW55 soft starter with screw terminals for operational voltage up to 480 V: Standard delivery time SD = 1 day (d).

Note:

For the constraints for the motor outputs specified here, see page 7/7.

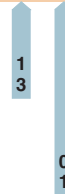

# High Performance Soft Starters

3RW55 soft starters > Inline circuit **IE3/IE4 ready**

For normal starting (CLASS 10E)



3RW553.



3RW554.



3RW555.

At 40 °C					At 50 °C					SD <sup>1)</sup>	Article No.	Price per PU	PU (UNIT, SET, M)	PS*
Operational current	Operating power for three-phase motors				Operational current	Rating [hp] for three-phase motors								
	At 230 V	At 400 V	At 500 V	At 690 V		At 200/208 V	At 220/230 V	At 460/480 V	At 575/600 V	d				
A	kW	kW	kW	kW	A	hp	hp	hp	hp					
<b>Operational voltage 200 ... 480 V</b>														
113	30	<b>55</b>	--	--	101	30	30	<b>75</b>	--	5	<b>3RW5534-□HA□4</b>		1	1 unit
143	37	<b>75</b>	--	--	128	40	40	<b>100</b>	--	5	<b>3RW5535-□HA□4</b>		1	1 unit
171	45	<b>90</b>	--	--	153	50	50	<b>100</b>	--	5	<b>3RW5536-□HA□4</b>		1	1 unit
210	55	<b>110</b>	--	--	186	50	60	<b>150</b>	--	5	<b>3RW5543-□HA□4</b>		1	1 unit
250	75	<b>132</b>	--	--	220	60	75	<b>150</b>	--	5	<b>3RW5544-□HA□4</b>		1	1 unit
315	90	<b>160</b>	--	--	279	75	100	<b>200</b>	--	5	<b>3RW5545-□HA□4</b>		1	1 unit
370	110	<b>200</b>	--	--	328	100	125	<b>250</b>	--	5	<b>3RW5546-□HA□4</b>		1	1 unit
470	132	<b>250</b>	--	--	416	150	150	<b>350</b>	--	5	<b>3RW5547-□HA□4</b>		1	1 unit
570	160	<b>315</b>	--	--	504	150	200	<b>400</b>	--	5	<b>3RW5548-□HA□4</b>		1	1 unit
630	200	<b>355</b>	--	--	561	200	200	<b>450</b>	--	15	<b>3RW5552-□HA□4</b>		1	1 unit
720	200	<b>400</b>	--	--	641	200	250	<b>500</b>	--	15	<b>3RW5553-□HA□4</b>		1	1 unit
840	250	<b>450</b>	--	--	748	250	300	<b>600</b>	--	15	<b>3RW5554-□HA□4</b>		1	1 unit
1 100	315	<b>560</b>	--	--	979	350	400	<b>850</b>	--	15	<b>3RW5556-□HA□4</b>		1	1 unit
1 280	400	<b>710</b>	--	--	1 139	400	450	<b>1 000</b>	--	15	<b>3RW5558-□HA□4</b>		1	1 unit

**Type of electrical connection for the control circuit**

Spring-loaded terminals  
Screw terminals

**Control supply voltage**

24 V AC/DC  
110 ... 250 V AC

<sup>1)</sup> 3RW55 soft starter with screw terminals for operational voltage up to 480 V: Standard delivery time SD = 1 day (d).

**Note:**

For the constraints for the motor outputs specified here, see page 7/7.

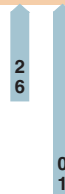

# High Performance Soft Starters

3RW55 soft starters > Inline circuit **IE3/IE4 ready**

For normal starting (CLASS 10E)



3RW551.



3RW552.

At 40 °C					At 50 °C					SD <sup>1)</sup>	Article No.	Price per PU	PU (UNIT, SET, M)	PS*
Operational current	Operating power for three-phase motors				Operational current	Rating [hp] for three-phase motors								
	At 230 V	At 400 V	At 500 V	At 690 V		At 200/208 V	At 220/230 V	At 460/480 V	At 575/600 V	A	hp	hp	hp	hp
<b>Operational voltage 200 ... 600 V</b>														
13	3	<b>5.5</b>	7.5	--	11.5	2	3	<b>7.5</b>	10	5	<b>3RW5513-□HA□5</b>		1	1 unit
18	4	<b>7.5</b>	11	--	15.9	3	5	<b>10</b>	10	5	<b>3RW5514-□HA□5</b>		1	1 unit
25	5.5	<b>11</b>	15	--	22.3	5	7.5	<b>15</b>	20	5	<b>3RW5515-□HA□5</b>		1	1 unit
32	7.5	<b>15</b>	18.5	--	28.4	7.5	10	<b>20</b>	25	5	<b>3RW5516-□HA□5</b>		1	1 unit
38	11	<b>18.5</b>	22	--	33.5	10	10	<b>20</b>	30	5	<b>3RW5517-□HA□5</b>		1	1 unit
<b>Operational voltage 200 ... 690 V</b>														
25	5.5	<b>11</b>	15	22	22.3	5	7.5	<b>15</b>	20	5	<b>3RW5521-□HA□6</b>		1	1 unit
47	11	<b>22</b>	30	45	41.6	10	10	<b>30</b>	40	5	<b>3RW5524-□HA□6</b>		1	1 unit
63	18.5	<b>30</b>	37	55	55.5	15	20	<b>40</b>	50	5	<b>3RW5525-□HA□6</b>		1	1 unit
77	22	<b>37</b>	45	75	68	20	25	<b>50</b>	60	5	<b>3RW5526-□HA□6</b>		1	1 unit
93	22	<b>45</b>	55	90	82.5	25	30	<b>60</b>	75	5	<b>3RW5527-□HA□6</b>		1	1 unit

**Type of electrical connection for the control circuit**

- Screw terminals
- Spring-loaded terminals

**Control supply voltage**

- 24 V AC/DC
- 110 ... 250 V AC

<sup>1)</sup> 3RW55 soft starter with screw terminals for operational voltage up to 690 V: Standard delivery time SD = 2 days (d).

**Note:**

For the constraints for the motor outputs specified here, see page 7/7.



# High Performance Soft Starters

3RW55 soft starters > Inline circuit **IE3/IE4 ready**

For normal starting (CLASS 10E)



3RW553.



3RW554.



3RW555.

At 40 °C					At 50 °C					SD <sup>1)</sup>	Article No.	Price per PU	PU (UNIT, SET, M)	PS*	
Operational current	Operating power for three-phase motors				Operational current	Rating [hp] for three-phase motors									
	At 230 V	At 400 V	At 500 V	At 690 V		At 200/208 V	At 220/230 V	At 460/480 V	At 575/600 V	A	hp	hp	hp	hp	d
A	kW	kW	kW	kW	A	hp	hp	hp	hp						
<b>Operational voltage 200 ... 690 V</b>															
113	30	<b>55</b>	75	110	101	30	30	<b>75</b>	100	5	<b>3RW5534-□HA□6</b>		1	1 unit	
143	37	<b>75</b>	90	132	128	40	40	<b>100</b>	125	5	<b>3RW5535-□HA□6</b>		1	1 unit	
171	45	<b>90</b>	110	160	153	50	50	<b>100</b>	150	5	<b>3RW5536-□HA□6</b>		1	1 unit	
210	55	<b>110</b>	132	200	186	60	60	<b>150</b>	150	5	<b>3RW5543-□HA□6</b>		1	1 unit	
250	75	<b>132</b>	160	250	220	60	75	<b>150</b>	200	5	<b>3RW5544-□HA□6</b>		1	1 unit	
315	90	<b>160</b>	200	315	279	75	100	<b>200</b>	250	5	<b>3RW5545-□HA□6</b>		1	1 unit	
370	110	<b>200</b>	250	355	328	100	125	<b>250</b>	300	5	<b>3RW5546-□HA□6</b>		1	1 unit	
470	132	<b>250</b>	315	400	416	150	150	<b>350</b>	450	5	<b>3RW5547-□HA□6</b>		1	1 unit	
570	160	<b>315</b>	355	560	504	150	200	<b>400</b>	500	5	<b>3RW5548-□HA□6</b>		1	1 unit	
630	200	<b>355</b>	400	630	561	200	200	<b>450</b>	600	15	<b>3RW5552-□HA□6</b>		1	1 unit	
720	200	<b>400</b>	500	710	641	200	250	<b>500</b>	700	15	<b>3RW5553-□HA□6</b>		1	1 unit	
840	250	<b>450</b>	560	800	748	250	300	<b>600</b>	800	15	<b>3RW5554-□HA□6</b>		1	1 unit	
1 100	215	<b>560</b>	710	1 000	979	350	400	<b>850</b>	1 100	15	<b>3RW5556-□HA□6</b>		1	1 unit	
1 280	400	<b>710</b>	900	1 200	1 139	400	450	<b>1 000</b>	1 250	15	<b>3RW5558-□HA□6</b>		1	1 unit	

**Type of electrical connection for the control circuit**

Spring-loaded terminals  
Screw terminals

**Control supply voltage**

24 V AC/DC  
110 ... 250 V AC

<sup>1)</sup> 3RW55 soft starter with screw terminals for operational voltage up to 690 V:  
- Sizes 3 and 4: Standard delivery time SD = 2 days (d).  
- Size 5: Standard delivery time SD = 5 days (d).

Note:

For the constraints for the motor outputs specified here, see page 7/7.

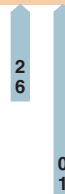

# High Performance Soft Starters

3RW55 soft starters > Inside-delta circuit **IE3/IE4 ready**

## Selection and ordering data

For normal starting (CLASS 10E)



3RW551.



3RW552.

At 40 °C for inside-delta circuit				At 50 °C for inside-delta circuit				SD <sup>1)</sup>	Article No.	Price per PU	PU (UNIT, SET, M)	PS*	
Operational current	Operating power for three-phase motors			Operational current	Rating [hp] for three-phase motors								
	At 230 V	At 400 V	At 500 V		At 200/208 V	At 220/230 V	At 460/480 V	At 575/600 V	d				
A	kW	kW	kW	A	hp	hp	hp	hp					
<b>Operational voltage 200 ... 480 V</b>													
22.5	5.5	<b>11</b>	--	19.9	5	5	<b>10</b>	--	5	3RW5513-□HA□4		1	1 unit
31.5	7.5	<b>15</b>	--	28	7.5	7.5	<b>20</b>	--	5	3RW5514-□HA□4		1	1 unit
43.3	11	<b>18.5</b>	--	39	10	10	<b>25</b>	--	5	3RW5515-□HA□4		1	1 unit
55.4	15	<b>22</b>	--	49	15	15	<b>30</b>	--	5	3RW5516-□HA□4		1	1 unit
65.8	18.5	<b>30</b>	--	58	15	20	<b>40</b>	--	5	3RW5517-□HA□4		1	1 unit
81.4	22	<b>45</b>	--	72	20	25	<b>50</b>	--	5	3RW5524-□HA□4		1	1 unit
109	30	<b>55</b>	--	96	30	30	<b>75</b>	--	5	3RW5525-□HA□4		1	1 unit
133	37	<b>75</b>	--	118	30	40	<b>75</b>	--	5	3RW5526-□HA□4		1	1 unit
161	45	<b>90</b>	--	143	40	50	<b>100</b>	--	5	3RW5527-□HA□4		1	1 unit

**Type of electrical connection for the control circuit**

- Screw terminals
- Spring-loaded terminals

**Control supply voltage**

- 24 V AC/DC
- 110 ... 250 V AC

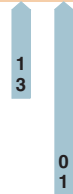

<sup>1)</sup> 3RW55 soft starter with screw terminals for operational voltage up to 480 V: Standard delivery time SD = 1 day (d).

Note:

For the constraints for the motor outputs specified here, see page 7/7.

# High Performance Soft Starters

3RW55 soft starters > Inside-delta circuit **IE3/IE4 ready**

For normal starting (CLASS 10E)



3RW553.

3RW554.

3RW555.

At 40 °C for inside-delta circuit				At 50 °C for inside-delta circuit				SD <sup>1)</sup>	Article No.	Price per PU	PU (UNIT, SET, M)	PS*	
Operational current	Operating power for three-phase motors			Operational current	Rating [hp] for three-phase motors								
	At 230 V	At 400 V	At 500 V		At 200/208 V	At 220/230 V	At 460/480 V	At 575/600 V	d				
A	kW	kW	kW	A	hp	hp	hp	hp					
<b>Operational voltage 200 ... 480 V</b>													
196	55	<b>110</b>	--	175	50	60	<b>125</b>	--	5	<b>3RW5534-□HA□4</b>		1	1 unit
248	75	<b>132</b>	--	222	75	75	<b>150</b>	--	5	<b>3RW5535-□HA□4</b>		1	1 unit
296	90	<b>160</b>	--	265	75	100	<b>200</b>	--	5	<b>3RW5536-□HA□4</b>		1	1 unit
364	110	<b>200</b>	--	322	100	125	<b>250</b>	--	5	<b>3RW5543-□HA□4</b>		1	1 unit
433	132	<b>250</b>	--	381	125	150	<b>300</b>	--	5	<b>3RW5544-□HA□4</b>		1	1 unit
546	160	<b>315</b>	--	483	150	200	<b>400</b>	--	5	<b>3RW5545-□HA□4</b>		1	1 unit
641	200	<b>355</b>	--	568	200	200	<b>450</b>	--	5	<b>3RW5546-□HA□4</b>		1	1 unit
814	250	<b>400</b>	--	721	250	250	<b>600</b>	--	5	<b>3RW5547-□HA□4</b>		1	1 unit
987	315	<b>560</b>	--	873	300	350	<b>750</b>	--	5	<b>3RW5548-□HA□4</b>		1	1 unit
1 091	355	<b>630</b>	--	972	350	400	<b>850</b>	--	15	<b>3RW5552-□HA□4</b>		1	1 unit
1 247	400	<b>710</b>	--	1 110	400	450	<b>950</b>	--	15	<b>3RW5553-□HA□4</b>		1	1 unit
1 454	450	<b>800</b>	--	1 295	450	550	<b>1 150</b>	--	15	<b>3RW5554-□HA□4</b>		1	1 unit
1 905	560	<b>1 000</b>	--	1 695	600	700	<b>1 500</b>	--	15	<b>3RW5556-□HA□4</b>		1	1 unit
2 217	710	<b>1 200</b>	--	1 973	700	850	<b>1 700</b>	--	15	<b>3RW5558-□HA□4</b>		1	1 unit

**Type of electrical connection for the control circuit**

- Spring-loaded terminals
- Screw terminals

**Control supply voltage**

- 24 V AC/DC
- 110 ... 250 V AC

<sup>1)</sup> 3RW55 soft starter with screw terminals for operational voltage up to 480 V: Standard delivery time SD = 1 day (d).

Note:

For the constraints for the motor outputs specified here, see page 7/7.

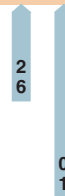

# High Performance Soft Starters

3RW55 soft starters > Inside-delta circuit **IE3/IE4 ready**

For normal starting (CLASS 10E)



3RW551.



3RW552.

At 40 °C for inside-delta circuit				At 50 °C for inside-delta circuit				SD <sup>1)</sup>	Article No.	Price per PU	PU (UNIT, SET, M)	PS*	
Operational current	Operating power for three-phase motors			Operational current	Rating [hp] for three-phase motors								
	At 230 V	At 400 V	At 500 V		At 200/208 V	At 220/230 V	At 460/480 V	At 575/600 V	d				
A	kW	kW	kW	A	hp	hp	hp	hp					
<b>Operational voltage 200 ... 600 V</b>													
22.5	5.5	<b>11</b>	15	19.9	5	5	<b>10</b>	15	5	<b>3RW5513-□HA□5</b>		1	1 unit
31.5	7.5	<b>15</b>	18.5	28	7.5	7.5	<b>20</b>	25	5	<b>3RW5514-□HA□5</b>		1	1 unit
43.3	11	<b>18.5</b>	22	39	10	10	<b>25</b>	30	5	<b>3RW5515-□HA□5</b>		1	1 unit
55.4	15	<b>22</b>	30	49	15	15	<b>30</b>	40	5	<b>3RW5516-□HA□5</b>		1	1 unit
65.8	18.5	<b>30</b>	37	58	15	20	<b>40</b>	50	5	<b>3RW5517-□HA□5</b>		1	1 unit
43.3	11	<b>18.5</b>	22	39	10	10	<b>25</b>	30	5	<b>3RW5521-□HA□6</b>		1	1 unit
81.4	22	<b>45</b>	45	72	20	25	<b>50</b>	60	5	<b>3RW5524-□HA□6</b>		1	1 unit
109	30	<b>55</b>	55	96	30	30	<b>75</b>	75	5	<b>3RW5525-□HA□6</b>		1	1 unit
133	37	<b>75</b>	90	118	30	40	<b>75</b>	100	5	<b>3RW5526-□HA□6</b>		1	1 unit
161	45	<b>90</b>	110	143	40	50	<b>100</b>	125	5	<b>3RW5527-□HA□6</b>		1	1 unit



**Type of electrical connection for the control circuit**

- Screw terminals
- Spring-loaded terminals

**Control supply voltage**

- 24 V AC/DC
- 110 ... 250 V AC

<sup>1)</sup> 3RW55 soft starter with screw terminals for operational voltage up to 600 V: Standard delivery time SD = 2 days (d).

**Note:**

For the constraints for the motor outputs specified here, see page 7/7.



# High Performance Soft Starters

3RW55 soft starters > Inside-delta circuit **IE3/IE4 ready**

For normal starting (CLASS 10E)



3RW553.

3RW554.

3RW555.

At 40 °C for inside-delta circuit				At 50 °C for inside-delta circuit				SD <sup>1)</sup>	Article No.	Price per PU	PU (UNIT, SET, M)	PS*	
Operational current	Operating power for three-phase motors			Operational current	Rating [hp] for three-phase motors								
	At 230 V	At 400 V	At 500 V		At 200/208 V	At 220/230 V	At 460/480 V	At 575/600 V					
A	kW	kW	kW	A	hp	hp	hp	hp	d				
<b>Operational voltage 200 ... 600 V</b>													
196	55	<b>110</b>	132	175	50	60	<b>125</b>	150	5	<b>3RW5534-□HA□6</b>		1	1 unit
248	75	<b>132</b>	160	222	75	75	<b>150</b>	200	5	<b>3RW5535-□HA□6</b>		1	1 unit
296	90	<b>160</b>	200	265	75	100	<b>200</b>	250	5	<b>3RW5536-□HA□6</b>		1	1 unit
364	110	<b>200</b>	250	322	100	125	<b>250</b>	300	5	<b>3RW5543-□HA□6</b>		1	1 unit
433	132	<b>250</b>	315	381	125	150	<b>300</b>	350	5	<b>3RW5544-□HA□6</b>		1	1 unit
546	160	<b>315</b>	355	483	150	200	<b>400</b>	500	5	<b>3RW5545-□HA□6</b>		1	1 unit
641	200	<b>355</b>	450	568	200	200	<b>450</b>	600	5	<b>3RW5546-□HA□6</b>		1	1 unit
814	250	<b>400</b>	500	721	250	250	<b>600</b>	800	5	<b>3RW5547-□HA□6</b>		1	1 unit
987	315	<b>560</b>	630	873	300	350	<b>750</b>	950	5	<b>3RW5548-□HA□6</b>		1	1 unit
1 091	355	<b>630</b>	710	972	350	400	<b>850</b>	1 050	15	<b>3RW5552-□HA□6</b>		1	1 unit
1 247	400	<b>710</b>	800	1 110	400	450	<b>950</b>	1 250	15	<b>3RW5553-□HA□6</b>		1	1 unit
1 454	450	<b>800</b>	900	1 295	450	550	<b>1 150</b>	1 450	15	<b>3RW5554-□HA□6</b>		1	1 unit
1 905	560	<b>1 000</b>	1 200	1 695	600	700	<b>1 500</b>	1 900	15	<b>3RW5556-□HA□6</b>		1	1 unit
2 217	710	<b>1 200</b>	1 500	1 973	700	850	<b>1 700</b>	2 200	15	<b>3RW5558-□HA□6</b>		1	1 unit

**Type of electrical connection for the control circuit**

- Spring-loaded terminals
- Screw terminals

**Control supply voltage**

- 24 V AC/DC
- 110 ... 250 V AC



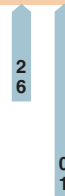

<sup>1)</sup> 3RW55 soft starter with screw terminals for operational voltage up to 600 V:  
 - Sizes 3 and 4: Standard delivery time SD = 2 days (d).  
 - Size 5: Standard delivery time SD = 5 days (d).

Note:

For the constraints for the motor outputs specified here, see page 7/7.

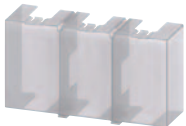
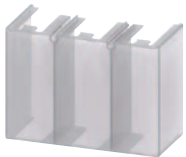





## Selection and ordering data

Product designation	Manufacturer's Article No. of the soft starter	Type of product	Application	SD	Article No.	Price per PU	PU (UNIT, SET, M)	PS*
<b>Fan covers</b>								
	<b>Fan cover</b>	3RW551 (1x), 3RW552 (2x), 3RW553 (2x)	--	--	▶	<b>3RW5983-0FC00</b>	1	1 unit
3RW5983-0FC00		3RW554 (1x)	--	--	▶	<b>3RW5984-0FC00</b>	1	1 unit
		3RW555 (3x)	--	--	▶	<b>3RW5985-0FC00</b>	1	1 unit
<b>Terminal covers</b>								
	<b>Terminal cover</b>	3RW552 (2x), 3RW553 (2x)	--	--	▶	<b>3RW5983-0TC20</b>	1	1 unit
3RW5983-0TC20		3RW554 (2x)	--	--	▶	<b>3RW5984-0TC20</b>	1	1 unit
								
3RW5984-0TC20								
<b>Enclosure components</b>								
	<b>Hinged cover</b>	3RW55	Without cutout	--	▶	<b>3RW5950-0GL20</b>	1	1 unit
3RW5950-0GL20								
<b>Communication modules</b>								
	<b>Communication module</b>	3RW55	PROFINET High Feature with integral switch	--	▶	<b>3RW5950-0CH00</b>	1	1 unit
3RW5980-0CS00			PROFINET Standard	--	▶	<b>3RW5980-0CS00</b>	1	1 unit
			PROFIBUS	--	▶	<b>3RW5980-0CP00</b>	1	1 unit
			EtherNet/IP	--	▶	<b>3RW5980-0CE00</b>	1	1 unit
3RW5980-0CE00								
			Modbus RTU	--	▶	<b>3RW5980-0CR00</b>	1	1 unit
3RW5980-0CR00			Modbus TCP	--	▶	<b>3RW5980-0CT00</b>	1	1 unit

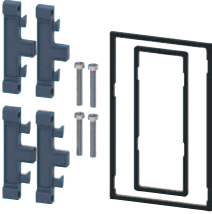
# High Performance Soft Starters

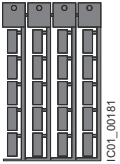
## 3RW55 soft starters > Accessories

Product designation	Manufacturer's Article No. of the soft starter	Type of product	Application	SD	Article No.	Price per PU	PU (UNIT, SET, M)	PS*
<b>HMI modules</b>								
	<b>IP65 door mounting kit for HMI modules</b>	3RW55	IP65	For HMI modules	▶	<b>3RW5980-0HD00</b>	1	1 unit
3RW5980-0HD00								
<b>Connecting cables</b>								
	<b>HMI connection cable</b>	3RW55	5 m, round	For door mounting	▶	<b>3RW5980-0HC60</b>	1	1 unit
			2.5 m, round		▶	<b>3UF7933-0BA00-0</b>	1	1 unit
			1.0 m, round		▶	<b>3UF7937-0BA00-0</b>	1	1 unit
			0.5 m, round		▶	<b>3UF7932-0BA00-0</b>	1	1 unit
3UF793.-0BA00-0								
<b>Further accessories</b>								
	<b>Push-in lugs for wall mounting</b>	--	Two lugs are required per device	For HMI modules and communication modules	2	<b>3ZY1311-0AA00</b>	1	10 units
3ZY1311-0AA00								
<b>Blank labels</b>								
	<b>Unit labeling plates<sup>1)</sup></b>		20 mm x 7 mm, titanium gray	For SIRIUS devices	20	<b>3RT2900-1SB20</b>	100	340 units
3RT2900-1SB20								
<b>3RW55 starter kit</b>								
	<b>SIRIUS 3RW55 starter kit</b>	--	Including 3RW55 soft starter 13 A, 200 ... 480 V, 24 V AC/DC Soft Starter ES V15.1, 24 V power supply unit, connecting cable and RJ45 network cable		5	<b>3RW5951-1ES04</b>	1	1 unit
3RW5951-1ES04								

<sup>1)</sup> PC labeling systems for individual inscription of unit labeling plates are available from: murrplastik Systemtechnik GmbH (see page 16/15).

# High Performance Soft Starters

3RW55 Failsafe soft starters > General data **NEW**

## Overview

### More information

Homepage, see [www.usa.siemens.com/soft-starter](http://www.usa.siemens.com/soft-starter)  
 Industry Mall, see [www.siemens.com/product?3RW](http://www.siemens.com/product?3RW)  
 Industry Online Support (SIOS) topic page, see <https://support.industry.siemens.com/cs/ww/en/view/109747404>

Simulation Tool for Soft Starters (STS), see page 7/7 or <https://support.industry.siemens.com/cs/ww/en/view/101494917>  
 SIRIUS Soft Starter ES (TIA Portal), see page 14/2



Equipped with the utmost functionality, the SIRIUS 3RW55 Failsafe High Performance soft starters confidently handle even difficult starting and stopping operations. Thanks to innovative torque control, the device can be used for drives with an output of between 7.5 to 400HP @ 480V.

The innovative 3RW55 Failsafe soft starter features an integrated fail-safe digital input for directly connecting the EMERGENCY STOP, and thus covers SIL 1 STO applications. The HMI (with color display, local interface and a slot for micro SD memory card) and plug-in communication modules (PROFINET, PROFIBUS, EtherNet/IP and Modbus) ensure maximum flexibility. With their modern hybrid switching technology, the 3RW55 Failsafe soft starters offer efficient switching for long-term, energy-saving use.

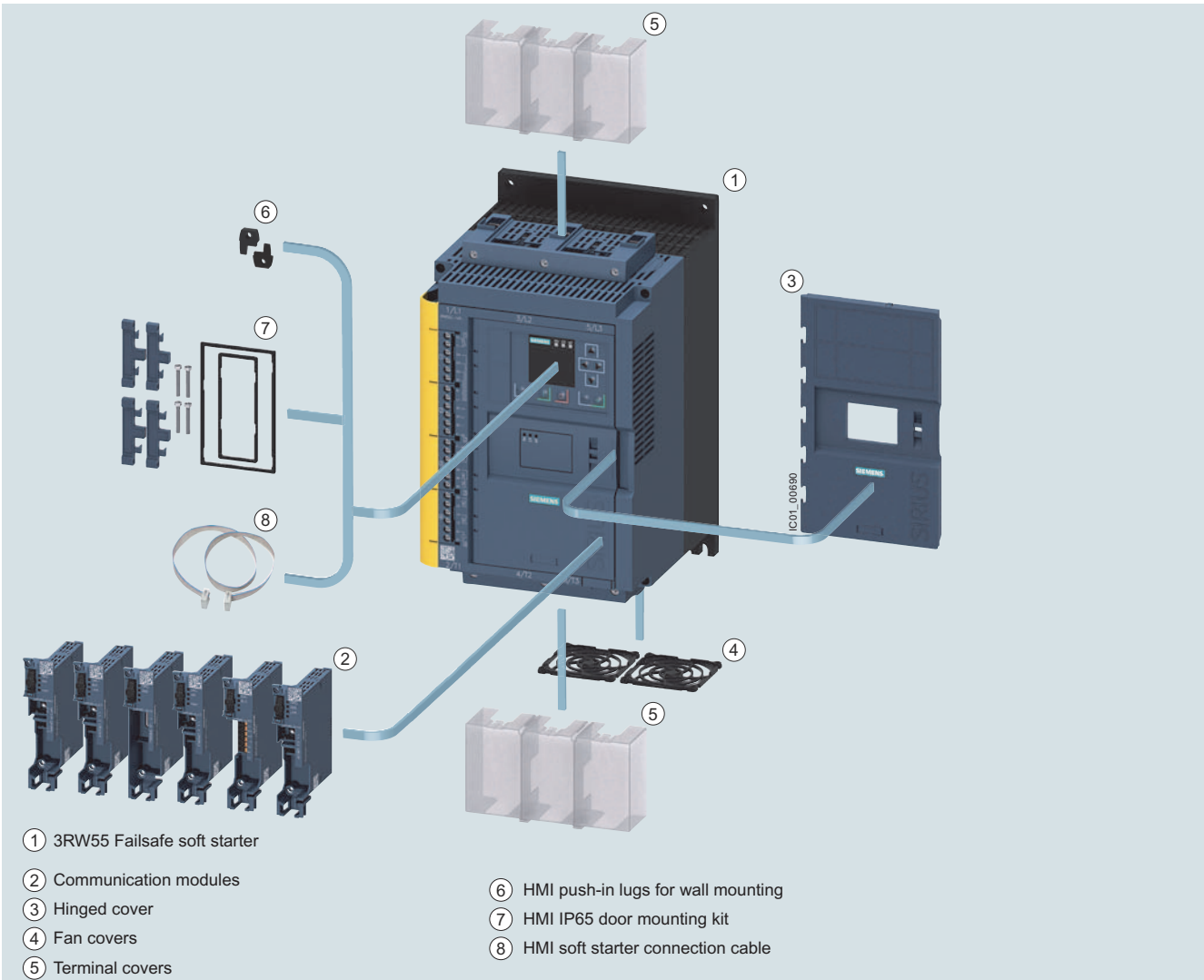

- ① 3RW55 Failsafe soft starter
- ② Communication modules
- ③ Hinged cover
- ④ Fan covers
- ⑤ Terminal covers
- ⑥ HMI push-in lugs for wall mounting
- ⑦ HMI IP65 door mounting kit
- ⑧ HMI soft starter connection cable

3RW55 Failsafe High Performance soft starters with accessories, see page 7/51.

## Benefits

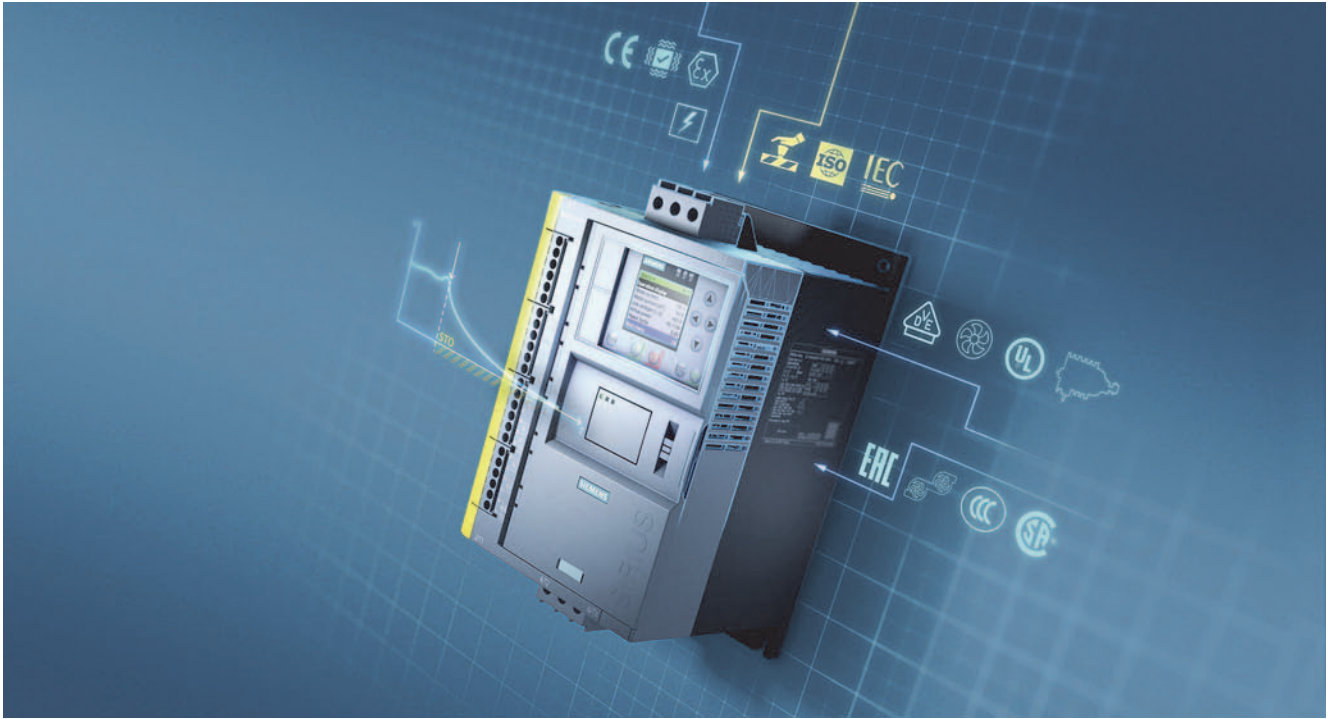

Product characteristics / function	Performance features / benefits
Automatic parameterization	Extremely easy commissioning and reliability even under changing load conditions
Hybrid switching devices and three-phase motor control	Minimum power loss and optimum/symmetrical motor control
Integration into TIA Portal – communication modules optional	Efficient configuration and maximum flexibility in automation engineering
Removable HMI with color display, local interface, slot for micro SD memory card	Maximum flexibility with regard to user interface and intuitive menu guidance
Pump stop and torque control	Reduced mechanical loading and optimum pump stop control
Certified according to ATEX/IECEX directive	Suitable for the starting of explosion-proof motors
Fail-safe disconnection up to SIL 3 - PL e / STO	Reduced costs and space requirements thanks to direct wiring of the EMERGENCY STOP mushroom pushbutton to the soft starter for SIL 1

## Technical specifications

## More information

Technical specifications, see <https://support.industry.siemens.com/cs/ww/en/ps/25776/td>  
 Equipment Manual "SIRIUS 3RW55 Soft Starter", see <https://support.industry.siemens.com/cs/ww/en/view/109753752>

FAQs, see <https://support.industry.siemens.com/cs/ww/en/ps/25776/faq>  
 Simulation Tool for Soft Starters (STS), see page 7/7 or <https://support.industry.siemens.com/cs/ww/en/view/101494917>

## Type

3RW551.-.HF.4

3RW552.-.HF.4  
3RW553.-.HF.4

3RW554.-.HF.4

## Installation/fixing/dimensions

## Width x height x depth

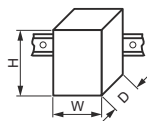

mm

170 × 275 × 152

185 × 306 × 203

210 × 393 × 203

## Type of mounting

Screw fixing

## Mounting position

Vertical (can be rotated +/- 90° and tilted +/- 22.5° forward or backward)

## Distance to be maintained with side-by-side mounting

- Above mm 100
- At the side mm 5
- Below mm 75

Maximum installation altitude above sea level<sup>1)</sup>

m 2 000

## Degree of protection

IP00

## Ambient conditions

## Ambient temperature

- During operation<sup>2)</sup> °C -25 ... +60
- During storage and transport °C -40 ... +80

## Environmental category according to IEC 60721

- During operation 3K6 (no ice formation, no condensation), 3C3 (no salt mist), 3S2 (sand must not get into the devices), 3M6
- During storage 1K6 (only occasional condensation), 1C2 (no salt mist), 1S2 (sand must not enter the devices), 1M4
- During transport 2K2, 2C1, 2S1, 2M2 (max. height of fall 0.3 m)

<sup>1)</sup> Derating from 1 000 m, see characteristic curve on page 7/7.

<sup>2)</sup> Note derating above 40 °C.

Type		3RW55..-HF0.	3RW55..-HF1.
<b>Control circuit/control</b>			
<b>Control supply voltage</b>			
• At AC/DC, rated value	V	24/24	--/--
• At AC	V	--	110 ... 250
• Relative negative tolerance/relative positive tolerance with AC	%	-20/20	-15/10
• Relative negative tolerance/relative positive tolerance with DC	%	-20/20	--/--
<b>Frequency of the control supply voltage</b>			
• Relative negative tolerance/relative positive tolerance	Hz	50 ... 60	
	%	-10/10	
<b>Type of overvoltage protection</b>			
Varistors			
<b>Type of short-circuit protection for control circuit<sup>1)</sup></b>			
Fuse 4 A gG ( $I_{CU} = 1$ kA), fuse 6 A quick-response ( $I_{CU} = 1$ kA), MCB C1 ( $I_{CU} = 600$ A), MCB C6 ( $I_{CU} = 300$ A)			

<sup>1)</sup> Not included in scope of supply

Type		3RW55..-HF4
<b>Power electronics</b>		
<b>Operational voltage, rated value</b>		
• Relative negative tolerance/relative positive tolerance	V	200 ... 480
	%	-15/10
<b>Operational voltage for inside-delta circuit, rated value</b>		
• Relative negative tolerance/relative positive tolerance	V	200 ... 480
	%	-15/10
<b>Operating frequency, rated value</b>		
• Relative negative tolerance/relative positive tolerance	Hz	50 ... 60
	%	-10/10
<b>Minimum load [% of <math>I_M</math>]<sup>1)</sup></b>		
	%	10
<b>Maximum cable length between soft starter and motor</b>		
	m	800

<sup>1)</sup> Relative to set  $I_e$ .

## High Performance Soft Starters

3RW55 Failsafe soft starters > General data **NEW**

Type		3RW5513	3RW5514	3RW5515	3RW5516	3RW5517
<b>Rated operational current <math>I_e</math></b>	A	13	18	25	32	38
<b>Power electronics</b>						
<b>Load rating with rated operational current <math>I_e</math></b>						
IEC + UL/CSA, individual mounting at 40/50/60 °C, AC-53a	A	13/11.5/10.5	18/15.9/13.8	25/22.3/19.6	25/22.3/19.6	38/33.5/30.5
<b>Permissible rated motor current and starts/h</b>						
<b>Normal starting (CLASS 10A)</b>						
Rated motor current $I_M$ , $T_U = 40/50/60$ °C ON period = 70%; motor protection activated	A	13/11.5/10.5	18/15.9/13.8	25/22.3/19.6	32/28.4/26	38/33.5/30.5
• 300% $I_M$						
- Start-up time 5 s	1/h	43	43	43	43	43
- Start-up time 10 s	1/h	18	18	18	18	18
• 350% $I_M$						
- Start-up time 5 s	1/h	28	28	28	28	28
- Start-up time 10 s	1/h	10	10	10	10	10
<b>Normal starting (CLASS 10E)</b>						
Rated motor current $I_M$ , $T_U = 40/50/60$ °C ON period = 70%; motor protection activated	A	13/11.5/10.5	18/15.9/13.8	25/22.3/19.6	32/28.4/26	38/33.5/30.5
• 300% $I_M$						
- Start-up time 5 s	1/h	21	21	21	21	21
- Start-up time 10 s	1/h	8	8	8	8	8
• 350% $I_M$						
- Start-up time 5 s	1/h	13	13	13	13	13
- Start-up time 10 s	1/h	4	4	4	4	4
<b>Heavy starting (CLASS 20E)</b>						
Rated motor current $I_M$ , $T_U = 40/50/60$ °C ON period = 70%; motor protection activated	A	13/11.5/10.5	18/15.9/13.8	25/22.3/19.6	29.6/27.2/23.6	33.5/30.5/27.5
• 300% $I_M$						
- Start-up time 20 s	1/h	10	10	10	10	10
- Start-up time 40 s	1/h	4	4	4	4	4
• 350% $I_M$						
- Start-up time 20 s	1/h	7	7	7	7	7
- Start-up time 40 s	1/h	2.5	2.5	2.5	2.5	2.5
<b>Heavy starting (CLASS 30E)</b>						
Rated motor current $I_M$ , $T_U = 40/50/60$ °C ON period = 70%; motor protection activated	A	13/11.5/10.5	18/15.9/13.8	25/22.3/19.6	26/23.6/21.2	29/26/23
• 300% $I_M$						
- Start-up time 20 s	1/h	7	7	7	7	7
- Start-up time 40 s	1/h	3	3	3	3	3
• 350% $I_M$						
- Start-up time 20 s	1/h	4	4	4	4	4
- Start-up time 40 s	1/h	1.8	1.8	1.8	1.8	1.8
<b>Adjustable rated motor current <math>I_M</math></b>						
• Minimum/maximum	A	2.5/13	3.5/18	5/25	6.5/32	7.5/38
• Minimum/maximum in inside-delta circuits	A	4.3/22.5	6.1/31.1	8.7/43.3	11.3/55.4	13/65.8



## High Performance Soft Starters

3RW55 Failsafe soft starters > General data **NEW**

Type		3RW5524	3RW5525	3RW5526	3RW5527
<b>Rated operational current <math>I_e</math></b>	A	47	63	77	93
<b>Power electronics</b>					
<b>Load rating with rated operational current <math>I_e</math></b>					
IEC + UL/CSA, individual mounting at 40/50/60 °C, AC-53a	A	47/41.6/36.2	63/55.5/50.5	77/68/62	93/82.5/75.5
<b>Permissible rated motor current and starts/h</b>					
<b>Normal starting (CLASS 10A)</b>					
Rated motor current $I_M$ , $T_U = 40/50/60$ °C ON period = 70%; motor protection activated	A	47/41.6/36.2	63/55.5/50.5	77/68/62	93/82.5/75.5
• 300% $I_M$					
- Start-up time 5 s	1/h	43	43	43	43
- Start-up time 10 s	1/h	18	18	18	18
• 350% $I_M$					
- Start-up time 5 s	1/h	28	28	28	28
- Start-up time 10 s	1/h	10	10	10	10
<b>Normal starting (CLASS 10E)</b>					
Rated motor current $I_M$ , $T_U = 40/50/60$ °C ON period = 70%; motor protection activated	A	47/41.6/36.2	63/55.5/50.5	77/68/62	93/82.5/75.5
• 300% $I_M$					
- Start-up time 5 s	1/h	21	21	21	21
- Start-up time 10 s	1/h	8	8	8	8
• 350% $I_M$					
- Start-up time 5 s	1/h	13	13	13	13
- Start-up time 10 s	1/h	4	4	4	4
<b>Heavy starting (CLASS 20E)</b>					
Rated motor current $I_M$ , $T_U = 40/50/60$ °C ON period = 70%; motor protection activated	A	47/41.6/36.2	63/55.5/50.5	77/68/62	93/82.5/75.5
• 300% $I_M$					
- Start-up time 20 s	1/h	10	10	10	10
- Start-up time 40 s	1/h	4	4	4	4
• 350% $I_M$					
- Start-up time 20 s	1/h	7	7	7	7
- Start-up time 40 s	1/h	2.5	0	0	0
<b>Heavy starting (CLASS 30E)</b>					
Rated motor current $I_M$ , $T_U = 40/50/60$ °C ON period = 70%; motor protection activated	A	43.4/38/34.4	53/48/43	68/62/56	82.5/75.5/65
• 300% $I_M$					
- Start-up time 20 s	1/h	7	7	7	7
- Start-up time 40 s	1/h	3	3	3	3
• 350% $I_M$					
- Start-up time 20 s	1/h	4	4	4	4
- Start-up time 40 s	1/h	1.8	1.8	1.8	1.8
<b>Adjustable rated motor current <math>I_M</math></b>					
• Minimum/maximum	A	10/47	13/63	16/77	19/93
• Minimum/maximum in inside-delta circuits	A	17.3/81.4	22.5/109	27.7/133	32.9/161

## High Performance Soft Starters

3RW55 Failsafe soft starters > General data **NEW**

Type		3RW5534	3RW5535	3RW5536
<b>Rated operational current <math>I_e</math></b>	A	113	143	171
<b>Power electronics</b>				
<b>Load rating with rated operational current <math>I_e</math></b>				
IEC + UL/CSA, individual mounting at 40/50/60 °C, AC-53a	A	113/101/89	143/128/118	171/153/141
<b>Permissible rated motor current and starts/h</b>				
<b>Normal starting (CLASS 10A)</b>				
Rated motor current $I_M$ , $T_U = 40/50/60$ °C ON period = 70%; motor protection activated	A	113/101/89	143/128/118	171/153/141
• 300% $I_M$				
- Start-up time 5 s	1/h	43	43	35
- Start-up time 10 s	1/h	18	18	13
• 350% $I_M$				
- Start-up time 5 s	1/h	28	17	10
- Start-up time 10 s	1/h	10	4	0
<b>Normal starting (CLASS 10E)</b>				
Rated motor current $I_M$ , $T_U = 40/50/60$ °C ON period = 70%; motor protection activated	A	113/101/89	143/128/118	171/153/141
• 300% $I_M$				
- Start-up time 5 s	1/h	21	21	14
- Start-up time 10 s	1/h	8	7	4
• 350% $I_M$				
- Start-up time 5 s	1/h	13	4	0
- Start-up time 10 s	1/h	4	0	0
<b>Heavy starting (CLASS 20E)</b>				
Rated motor current $I_M$ , $T_U = 40/50/60$ °C ON period = 70%; motor protection activated	A	109/97/85	128/113/103	141/129/117
• 300% $I_M$				
- Start-up time 20 s	1/h	10	10	10
- Start-up time 40 s	1/h	4	4	4
• 350% $I_M$				
- Start-up time 20 s	1/h	7	6	6
- Start-up time 40 s	1/h	0	0	0
<b>Heavy starting (CLASS 30E)</b>				
Rated motor current $I_M$ , $T_U = 40/50/60$ °C ON period = 70%; motor protection activated	A	89/81/74	108/98/88	117/105/93
• 300% $I_M$				
- Start-up time 20 s	1/h	7	7	7
- Start-up time 40 s	1/h	3	3	3
• 350% $I_M$				
- Start-up time 20 s	1/h	4	4	4
- Start-up time 40 s	1/h	1.8	1.8	1.8
<b>Adjustable rated motor current <math>I_M</math></b>				
• Minimum/maximum	A	23/113	29/143	34/171
• Minimum/maximum in inside-delta circuits	A	39.8/195	50.2/247	58.9/296

Type		3RW5543	3RW5544	3RW5545	3RW5546	3RW5547	3RW5548
<b>Rated operational current <math>I_e</math></b>	A	210	250	315	370	470	570
<b>Power electronics</b>							
<b>Load rating with rated operational current <math>I_e</math></b>							
IEC + UL/CSA, individual mounting at 40/50/60 °C, A AC-53a		210/186/170	250/220/200	315/279/255	370/328/300	470/416/380	570/504/460
<b>Permissible rated motor current and starts/h</b>							
<b>Normal starting (CLASS 10A)</b>							
Rated motor current $I_M$ , $T_U = 40/50/60$ °C ON period = 70%; motor protection activated	A	210/186/170	250/220/200	315/279/255	370/328/300	470/416/380	570/504/460
• 300% $I_M$							
- Start-up time 5 s	1/h	43	43	38	43	32	13
- Start-up time 10 s	1/h	13	18	14	18	13	3
• 350% $I_M$							
- Start-up time 5 s	1/h	14	28	19	28	19	4
- Start-up time 10 s	1/h	0	10	5	10	6	0.4
<b>Normal starting (CLASS 10E)</b>							
Rated motor current $I_M$ , $T_U = 40/50/60$ °C ON period = 70%; motor protection activated	A	210/186/170	250/220/200	315/279/255	370/328/300	470/416/380	551/490/445
• 300% $I_M$							
- Start-up time 5 s	1/h	13	21	14	20	13	5
- Start-up time 10 s	1/h	2	8	4	8	3	--
• 350% $I_M$							
- Start-up time 5 s	1/h	0	13	5	12	6	1
- Start-up time 10 s	1/h	0	4	0	3	0.4	--
<b>Heavy starting (CLASS 20E)</b>							
Rated motor current $I_M$ , $T_U = 40/50/60$ °C ON period = 70%; motor protection activated	A	162/146/130	200/180/160	231/207/183	258/230/202	272/254/236	284/262/240
• 300% $I_M$							
- Start-up time 20 s	1/h	10	10	10	10	10	10
- Start-up time 40 s	1/h	4	4	4	4	4	4
• 350% $I_M$							
- Start-up time 20 s	1/h	7	7	7	7	7	7
- Start-up time 40 s	1/h	2	2.5	2.5	2.5	2.5	2.5
<b>Heavy starting (CLASS 30E)</b>							
Rated motor current $I_M$ , $T_U = 40/50/60$ °C ON period = 70%; motor protection activated	A	138/122/106	160/140/120	183/159/135	202/174/160	210/190/170	220/200/180
• 300% $I_M$							
- Start-up time 20 s	1/h	7	7	7	7	7	7
- Start-up time 40 s	1/h	3	3	3	3	3	3
• 350% $I_M$							
- Start-up time 20 s	1/h	4	4	4	4	4	4
- Start-up time 40 s	1/h	1.8	1.8	1.8	1.8	1.8	1.8
<b>Adjustable rated motor current <math>I_M</math></b>							
• Minimum/maximum	A	42/210	50/250	63/315	74/370	94/470	114/570
• Minimum/maximum in inside-delta circuits	A	72.7/363	86.6/433	109.1/545	128.2/640	162.8/814	197.5/987

# High Performance Soft Starters

3RW55 Failsafe soft starters > General data **NEW**

**Motor feeders according to IEC with 3RV2/3VA motor starter protectors/circuit breakers (without semiconductor protection)**

Type of coordination "1", CLASS 10, short-circuit breaking capacity  $I_q$  in kA, see table

Note:

For general recommendations for constructing motor feeders with soft starters, see page 7/9.

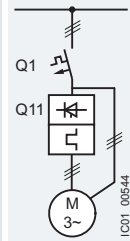
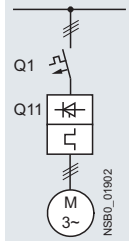

Soft starters	Motor starter protectors for 400 V systems				Motor starter protectors for 480 V systems			
	Q11 Type	$I_q$ kA	Q1 Type	$I_q$ kA	Q11 Type	$I_q$ kA	Q1 Type	$I_q$ kA
Type of coordination "1"	Inline circuit				Inside-delta circuit			
3RW5513	3RV2032-4TA10	65	3RV2032-4TA10	18	3RV2032-4DA10	65	3RV2032-4DA10	18
3RW5514	3RV2032-4DA10	65	3RV2032-4DA10	15	3RV2032-4EA10	65	3RV2032-4EA10	15
3RW5515	3RV2032-4EA10	65	3RV2032-4EA10	15	3RV2032-4VA10	65	3RV2032-4VA10	15
3RW5516	3RV2032-4VA10	65	3RV2032-4VA10	10	3RV2032-4JA10	65	3RV2032-4JA10	10
3RW5517	3RV2032-4WA10	65	3RV2032-4WA10	10	3RV2032-4RA10	65	3RV2032-4RA10	10
3RW5524	3RV2032-4JA10	65	3RV2032-4JA10	10	3RV2032-4RA10	65	3RV2032-4RA10	10
3RW5525	3VA2163-7MN32-0AA0	65	3VA2163-7MN32-0AA0	20	3VA2110-7MN32-0AA0	65	3VA2110-7MN32-0AA0	20
3RW5526	3VA2110-7MN32-0AA0	65	3VA2110-7MN32-0AA0	20	3VA2216-7MN32-0AA0	65	3VA2216-7MN32-0AA0	20
3RW5527	3VA2216-7MN32-0AA0	15	3VA2216-7MN32-0AA0	10	3VA2220-7MN32-0AA0	15	3VA2220-7MN32-0AA0	10
3RW5534	3VA2216-7MN32-0AA0	65	--	--	3VA2220-7MN32-0AA0	65	--	--
3RW5535	3VA2220-7MN32-0AA0	65	--	--	3VA2325-7MN32-0AA0	65	--	--
3RW5536	3VA2325-7MN32-0AA0	30	3VA2325-7MN32-0AA0	10	3VA2440-7MN32-0AA0	30	3VA2440-7MN32-0AA0	10
3RW5543	3VA2325-7MN32-0AA0	65	3VA2325-7MN32-0AA0	65	3VA2440-7MN32-0AA0	65	3VA2440-7MN32-0AA0	65
3RW5544	3VA2440-7MN32-0AA0	65	3VA2440-7MN32-0AA0	65	3VA2450-7MN32-0AA0	65	3VA2450-7MN32-0AA0	65
3RW5545	3VA2440-7MN32-0AA0	65	3VA2440-7MN32-0AA0	65	3VA2580-6HN32-0AA0	65	3VA2580-6HN32-0AA0	65
3RW5546	3VA2440-7MN32-0AA0	65	3VA2440-7MN32-0AA0	65	3VA2580-6HN32-0AA0	65	3VA2580-6HN32-0AA0	65
3RW5547	3VA2450-7MN32-0AA0	65	3VA2450-7MN32-0AA0	65	3VA2510-6HN32-0AA0	65	3VA2510-6HN32-0AA0	65
3RW5548	3VA2580-6HN32-0AA0	65	3VA2580-6HN32-0AA0	65	3VA2510-6HN32-0AA0	65	3VA2510-6HN32-0AA0	65

Note:

The service factor or measurement inaccuracies have been taken into account, for example, for the selection of the specified motor starter protectors/circuit breakers; the specified short-circuit breaking capacities  $I_q$  in kA are covered by combination tests. Smaller motor starter protectors/circuit breakers than those specified can be used at any time as smaller ones trip more quickly in the event of a short circuit (unchanged short-circuit breaking capacity) and thus protect the soft starter in any case. The dimensioning of the short-circuit components must, however, be suitable for the connected three-phase motor and the line protection for the cables used.

# High Performance Soft Starters

3RW55 Failsafe soft starters > General data **NEW**

### Motor feeders according to IEC with 3NA3 fuses

gG class full-range fuses for cable and line protection according to IEC 60269-2, without semiconductor protection

Type of coordination "1",  
short-circuit breaking capacity  $I_q = 65 \text{ kA}$

**Note:**

For general recommendations for constructing motor feeders with soft starters, [see page 7/9](#).

Soft starters	Inline circuit		Inside-delta circuit		
	gG class fuse	Line contactor (optional)	gG class fuse	Line contactor (optional)	Line contactor (optional)
Q11 Type	F1 Type	Q21 Type	F1 Type	Q21 Type	Q21 Type
Type of coordination "1" <span style="border: 1px solid black; padding: 2px;">TOC 1</span>	Inline circuit		Inside-delta circuit		
<b>3RW5513</b>	3NA3820-6	3RT2025	3NA3820-6	3RT2027	3RT2025
<b>3RW5514</b>	3NA3820-6	3RT2026	3NA3820-6	3RT2027	3RT2026
<b>3RW5515</b>	3NA3822-6	3RT2027	3NA3822-6	3RT2036	3RT2027
<b>3RW5516</b>	3NA3824-6	3RT2035	3NA3824-6	3RT2037	3RT2035
<b>3RW5517</b>	3NA3824-6	3RT2035	3NA3824-6	3RT2038	3RT2035
<b>3RW5524</b>	3NA3824-6	3RT2036	3NA3824-6	3RT2046	3RT2036
<b>3RW5525</b>	3NA3830-6	3RT2037	3NA3830-6	3RT2047	3RT2037
<b>3RW5526</b>	3NA3132-6	3RT2038	3NA3132-6	3RT1055	3RT2038
<b>3RW5527</b>	3NA3136-6	3RT2046	3NA3136-6	3RT1056	3RT2046
<b>3RW5534</b>	3NA3244-6	3RT1054	3NA3244-6	3RT1064	3RT1054
<b>3RW5535</b>	3NA3244-6	3RT1055	3NA3244-6	3RT1065	3RT1055
<b>3RW5536</b>	3NA3365-6	3RT1056	3NA3365-6	3RT1066	3RT1056
<b>3RW5543</b>	2 x 3NA3354-6	3RT1064	2 x 3NA3354-6	3RT1075	3RT1064
<b>3RW5544</b>	2 x 3NA3354-6	3RT1065	2 x 3NA3354-6	3RT1076	3RT1065
<b>3RW5545</b>	2 x 3NA3365-6	3RT1075	2 x 3NA3365-6	3TF68	3RT1075
<b>3RW5546</b>	2 x 3NA3365-6	3RT1075	2 x 3NA3365-6	3TF69	3RT1075
<b>3RW5547</b>	2 x 3NA3365-6	3RT1076	2 x 3NA3365-6	3TF69	3RT1076
<b>3RW5548</b>	2 x 3NA3365-6	3TF68	2 x 3NA3365-6	--	3TF68

**Note:**

The specified short-circuit breaking capacities  $I_q$  in kA are covered by combination tests. Smaller fuses than those specified can be used at any time as smaller ones trip more quickly in the event of a short circuit (unchanged short-circuit breaking capacity) and thus protect the soft starter in any case. The dimensioning of the short-circuit components must, however, be suitable for the connected three-phase motor and the line protection for the cables used.

# High Performance Soft Starters

3RW55 Failsafe soft starters > General data **NEW**

### Motor feeders according to IEC with 3NE1 SITOR fuses

gR class full-range fuses for semiconductor protection, cable and line protection

Type of coordination "2",  
short-circuit breaking capacity  $I_q = 65 \text{ kA}$

Note:

For general recommendations for constructing motor feeders with soft starters, [see page 7/9](#).

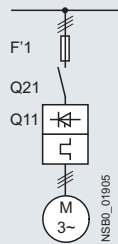

Soft starters	gG class fuse	Line contactor (optional)
Q11	F'1	Q21
Type	Type	Type
Type of coordination "2"	Inline circuit	
<b>3RW5513</b>	3NE1815-0	3RT2025
<b>3RW5514</b>	3NE1802-0	3RT2026
<b>3RW5515</b>	3NE1817-0	3RT2027
<b>3RW5516</b>	3NE1818-0	3RT2035
<b>3RW5517</b>	3NE1820-0	3RT2035
<b>3RW5524</b>	3NE1021-2	3RT2036
<b>3RW5525</b>	3NE1022-0	3RT2037
<b>3RW5526</b>	3NE1224-0	3RT2038
<b>3RW5527</b>	3NE1224-0	3RT2046
<b>3RW5534</b>	3NE1225-0	3RT1054
<b>3RW5535</b>	3NE1227-0	3RT1055
<b>3RW5536</b>	3NE1230-0	3RT1056
<b>3RW5543</b>	3NE1230-2	3RT1064
<b>3RW5544</b>	3NE1331-0	3RT1065
<b>3RW5545</b>	3NE1334-2	3RT1075
<b>3RW5546</b>	3NE1334-2	3RT1075
<b>3RW5547</b>	3NE1436-2	3RT1076
<b>3RW5548</b>	3NE1437-2	3TF68

Note:

The specified short-circuit breaking capacities  $I_q$  in kA are covered by combination tests. Smaller fuses than those specified can be used at any time as smaller ones trip more quickly in the event of a short circuit (unchanged short-circuit breaking capacity) and thus protect the soft starter in any case. The dimensioning of the short-circuit components must, however, be suitable for the connected three-phase motor and the line protection for the cables used.

In inside-delta circuits, a gR class full-range fuse could not provide the semiconductor protection of the delta-connected soft starter with a short-circuit breaking capacity that is adequate for practical use. In this case, we recommend using aR class partial-range fuses for semiconductor protection for type of coordination "2" ([see page 7/47](#)).

# High Performance Soft Starters

3RW55 Failsafe soft starters > General data **NEW**

## Motor feeders according to IEC with 3NE8 / 3NE3 / 3NC3 fuses

aR class partial-range fuses for semiconductor protection

Type of coordination "2",  
short-circuit breaking capacity  $I_{q} = 65 \text{ kA}$

Note:

For general recommendations for constructing motor feeders with soft starters, [see page 7/9](#).

Soft starters	Inline circuit			Inside-delta circuit			
	gG class fuse	aR class fuse	Line contactor (optional)	gG class fuse	aR class fuse	Line contactor (optional)	
Q11 Type	F1 Type	F3 Type	Q21 Type	F1 Type	F3 Type	Q21 Type	Q21 Type
Type of coordination "2"	Type of coordination "2"			Type of coordination "2"			
3RW5513	3NA3820-6	3NE8017-1	3RT2025	3NA3820-6	3NE8017-1	3RT2027	3RT2025
3RW5514	3NA3820-6	3NE8020-1	3RT2026	3NA3820-6	3NE8020-1	3RT2027	3RT2026
3RW5515	3NA3822-6	3NE8021-1	3RT2027	3NA3822-6	3NE8021-1	3RT2036	3RT2027
3RW5516	3NA3824-6	3NE8022-1	3RT2035	3NA3824-6	3NE8022-1	3RT2037	3RT2035
3RW5517	3NA3824-6	3NE8024-1	3RT2035	3NA3824-6	3NE8024-1	3RT2038	3RT2035
3RW5524	3NA3824-6	3NE8024-1	3RT2036	3NA3824-6	3NE8024-1	3RT2046	3RT2036
3RW5525	3NA3830-6	3NE3227	3RT2037	3NA3830-6	3NE3227	3RT2047	3RT2037
3RW5526	3NA3132-6	3NE3227	3RT2038	3NA3132-6	3NE3227	3RT1055	3RT2038
3RW5527	3NA3136-6	3NE3227	3RT2046	3NA3136-6	3NE3227	3RT1056	3RT2046
3RW5534	3NA3244-6	3NE3231	3RT1054	3NA3244-6	3NE3231	3RT1064	3RT1054
3RW5535	3NA3244-6	3NE3233	3RT1055	3NA3244-6	3NE3233	3RT1065	3RT1055
3RW5536	3NA3365-6	3NE3334-0B	3RT1056	3NA3365-6	3NE3334-0B	3RT1066	3RT1056
3RW5543	2 x 3NA3354-6	3NE3333	3RT1064	2 x 3NA3354-6	3NE3333	3RT1075	3RT1064
3RW5544	2 x 3NA3354-6	3NE3335	3RT1065	2 x 3NA3354-6	3NE3335	3RT1076	3RT1065
3RW5545	2 x 3NA3365-6	--	3RT1075	2 x 3NA3365-6	--	3TF68	3RT1075
3RW5546	2 x 3NA3365-6	--	3RT1075	2 x 3NA3365-6	--	3TF69	3RT1075
3RW5547	2 x 3NA3365-6	3NE3340-8	3RT1076	2 x 3NA3365-6	3NE3340-8	3TF69	3RT1076
3RW5548	2 x 3NA3365-6	3NC3342-1U	3TF68	2 x 3NA3365-6	3NC3342-1U	--	3TF68

Note:

The specified short-circuit breaking capacities  $I_{q}$  in kA are covered by combination tests. Smaller fuses than those specified can be used at any time as smaller ones trip more quickly in the event of a short circuit (unchanged short-circuit breaking capacity) and thus protect the soft starter in any case. The dimensioning of the short-circuit components must, however, be suitable for the connected three-phase motor and the line protection for the cables used.

For CLASS 10 applications, as an alternative to the gG class full-range fuses for cable and line protection 3NA3 (F1), 3RV2/3VA motor starter protectors/circuit breakers can also be used, possibly with reduced short-circuit breaking capacity (see page 7/44). In these cases, optional line contactors can be dispensed with.

## High Performance Soft Starters

3RW55 Failsafe soft starters > General data **NEW****Reversing operation with reversing contactors**Note:

For general recommendations for constructing motor feeders with soft starters, [see page 7/9](#).

(For an example circuit, [see 3RW55 Equipment Manual, Appendix A.3](#))

Soft starters	Reversing contactor assembly for systems up to 480 V Q21 / Q22	For reversing contactor for systems up to 480 V Q21 / Q22
Type	Type	Type
<b>3RW5513</b>	3RA2325	3RT2025
<b>3RW5514</b>	3RA2326	3RT2026
<b>3RW5515</b>	3RA2327	3RT2027
<b>3RW5516</b>	3RA2335	3RT2035
<b>3RW5517</b>	3RA2335	3RT2035
<b>3RW5524</b>	3RA2336	3RT2036
<b>3RW5525</b>	3RA2337	3RT2037
<b>3RW5526</b>	3RA2338	3RT2038
<b>3RW5527</b>	3RA2346	3RT2046
<b>3RW5534</b>	--	3RT1054
<b>3RW5535</b>	--	3RT1055
<b>3RW5536</b>	--	3RT1056
<b>3RW5543</b>	--	3RT1064
<b>3RW5544</b>	--	3RT1065
<b>3RW5545</b>	--	3RT1075
<b>3RW5546</b>	--	3RT1075
<b>3RW5547</b>	--	3RT1076
<b>3RW5548</b>	--	3TF68



# High Performance Soft Starters

3RW55 Failsafe soft starters > Inline circuit **IE3/IE4 ready** **NEW**

## Selection and ordering data

For normal starting (CLASS 10E)



At 40 °C			At 50 °C			SD <sup>1)</sup>	Article No.	Price per PU	PU (UNIT, SET, M)	PS*		
Operational current	Operating power for three-phase motors		Operational current	Rating [hp] for three-phase motors								
	At 230 V	At 400 V		At 200/208 V	At 220/230 V	At 460/480 V	d					
A	kW	kW	A	hp	hp	hp						
<b>Operational voltage 200 ... 480 V</b>												
13	3	<b>5.5</b>	11.5	2	3	<b>7.5</b>	5	3RW5513-□HF□4		1	1 unit	
18	4	<b>7.5</b>	15.9	3	5	<b>10</b>	5			3RW5514-□HF□4	1	1 unit
25	5.5	<b>11</b>	22.3	5	7.5	<b>15</b>	5			3RW5515-□HF□4	1	1 unit
32	7.5	<b>15</b>	28.4	7.5	10	<b>20</b>	5	3RW5516-□HF□4	1	1 unit		
38	11	<b>18.5</b>	33.5	10	10	<b>20</b>	5	3RW5517-□HF□4	1	1 unit		
47	11	<b>22</b>	41.6	10	10	<b>30</b>	5	3RW5524-□HF□4	1	1 unit		
63	18.5	<b>30</b>	55.5	15	20	<b>40</b>	5	3RW5525-□HF□4	1	1 unit		
77	22	<b>37</b>	68	20	25	<b>50</b>	5	3RW5526-□HF□4	1	1 unit		
93	22	<b>45</b>	82.5	25	30	<b>60</b>	5	3RW5527-□HF□4	1	1 unit		

**Type of electrical connection for the control circuit**

Screw terminals  
Spring-loaded terminals

**Control supply voltage**

24 V AC/DC  
110 ... 250 V AC

<sup>1)</sup> 3RW55 soft starter with screw terminals for operational voltage up to 480 V: Standard delivery time SD = 1 day (d).

Note:

For the constraints for the motor outputs specified here, see page 7/7.

1  
3  
0  
1

At 40 °C			At 50 °C			SD <sup>1)</sup>	Article No.	Price per PU	PU (UNIT, SET, M)	PS*		
Operational current	Operating power for three-phase motors		Operational current	Rating [hp] for three-phase motors								
	At 230 V	At 400 V		At 200/208 V	At 220/230 V	At 460/480 V	d					
A	kW	kW	A	hp	hp	hp						
<b>Operational voltage 200 ... 480 V</b>												
113	30	<b>55</b>	101	30	30	<b>75</b>	5	3RW5534-□HF□4		1	1 unit	
143	37	<b>75</b>	128	40	40	<b>100</b>	5			3RW5535-□HF□4	1	1 unit
171	45	<b>90</b>	153	50	50	<b>100</b>	5			3RW5536-□HF□4	1	1 unit
210	55	<b>110</b>	186	50	60	<b>150</b>	5	3RW5543-□HF□4	1	1 unit		
250	75	<b>132</b>	220	60	75	<b>150</b>	5	3RW5544-□HF□4	1	1 unit		
315	90	<b>160</b>	279	75	100	<b>200</b>	5	3RW5545-□HF□4	1	1 unit		
370	110	<b>200</b>	328	100	125	<b>250</b>	5	3RW5546-□HF□4	1	1 unit		
470	132	<b>250</b>	416	150	150	<b>350</b>	5	3RW5547-□HF□4	1	1 unit		
570	160	<b>315</b>	504	150	200	<b>400</b>	5	3RW5548-□HF□4	1	1 unit		

**Type of electrical connection for the control circuit**

Spring-loaded terminals  
Screw terminals

**Control supply voltage**

24 V AC/DC  
110 ... 250 V AC

<sup>1)</sup> 3RW55 soft starter with screw terminals for operational voltage up to 480 V: Standard delivery time SD = 1 day (d).

Note:

For the constraints for the motor outputs specified here, see page 7/7.

2  
6  
0  
1

# High Performance Soft Starters

3RW55 Failsafe soft starters > Inside-delta circuit **IE3/IE4 ready** **NEW**

## Selection and ordering data

For normal starting (CLASS 10E)

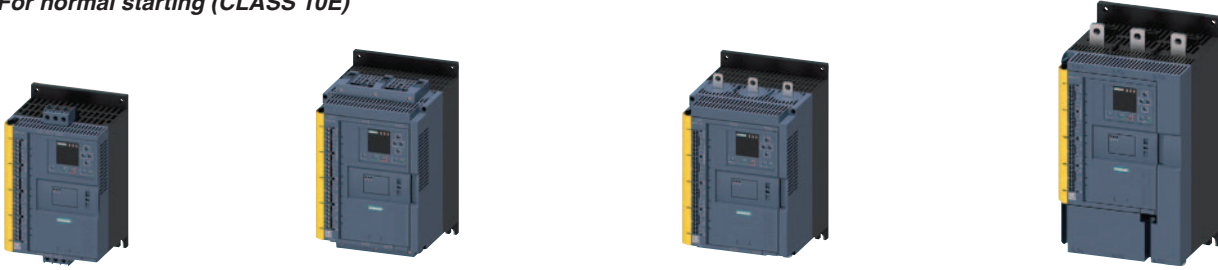

At 40 °C for inside-delta circuit			At 50 °C for inside-delta circuit			SD <sup>1)</sup>	Article No.	Price per PU	PU (UNIT, SET, M)	PS*	
Operational current	Operating power for three-phase motors		Operational current	Rating [hp] for three-phase motors							
	At 230 V	At 400 V		At 200/208 V	At 220/230 V	At 460/480 V	d				
A	kW	kW	A	hp	hp	hp					
<b>Operational voltage 200 ... 480 V</b>											
22.5	5.5	<b>11</b>	19.9	5	5	<b>10</b>	5	3RW5513-□HF□4		1	1 unit
31.5	7.5	<b>15</b>	28	7.5	7.5	<b>20</b>	5	3RW5514-□HF□4		1	1 unit
43.3	11	<b>18.5</b>	39	10	10	<b>25</b>	5	3RW5515-□HF□4		1	1 unit
55.4	15	<b>22</b>	49	15	15	<b>30</b>	5	3RW5516-□HF□4		1	1 unit
65.8	18.5	<b>30</b>	58	15	20	<b>40</b>	5	3RW5517-□HF□4		1	1 unit
81.4	22	<b>45</b>	72	20	25	<b>50</b>	5	3RW5524-□HF□4		1	1 unit
109	30	<b>55</b>	96	30	30	<b>75</b>	5	3RW5525-□HF□4		1	1 unit
133	37	<b>75</b>	118	30	40	<b>75</b>	5	3RW5526-□HF□4		1	1 unit
161	45	<b>90</b>	143	40	50	<b>100</b>	5	3RW5527-□HF□4		1	1 unit

**Type of electrical connection for the control circuit**

Screw terminals  
Spring-loaded terminals



**Control supply voltage**

24 V AC/DC  
110 ... 250 V AC

<sup>1)</sup> 3RW55 soft starter with screw terminals for operational voltage up to 480 V: Standard delivery time SD = 1 day (d).

**Note:**

For the constraints for the motor outputs specified here, see page 7/7.

SOFT STARTERS 7

At 40 °C for inside-delta circuit			At 50 °C for inside-delta circuit			SD <sup>1)</sup>	Article No.	Price per PU	PU (UNIT, SET, M)	PS*	
Operational current	Operating power for three-phase motors		Operational current	Rating [hp] for three-phase motors							
	At 230 V	At 400 V		At 200/208 V	At 220/230 V	At 460/480 V	d				
A	kW	kW	A	hp	hp	hp					
<b>Operational voltage 200 ... 480 V</b>											
196	55	<b>110</b>	175	50	60	<b>125</b>	5	3RW5534-□HF□4		1	1 unit
248	75	<b>132</b>	222	75	75	<b>150</b>	5	3RW5535-□HF□4		1	1 unit
296	90	<b>160</b>	265	75	100	<b>200</b>	5	3RW5536-□HF□4		1	1 unit
364	110	<b>200</b>	322	100	125	<b>250</b>	5	3RW5543-□HF□4		1	1 unit
433	132	<b>250</b>	381	125	150	<b>300</b>	5	3RW5544-□HF□4		1	1 unit
546	160	<b>315</b>	483	150	200	<b>400</b>	5	3RW5545-□HF□4		1	1 unit
641	200	<b>355</b>	568	200	200	<b>450</b>	5	3RW5546-□HF□4		1	1 unit
814	250	<b>400</b>	721	250	250	<b>600</b>	5	3RW5547-□HF□4		1	1 unit
987	315	<b>560</b>	873	300	350	<b>750</b>	5	3RW5548-□HF□4		1	1 unit

**Type of electrical connection for the control circuit**

Spring-loaded terminals  
Screw terminals



**Control supply voltage**

24 V AC/DC  
110 ... 250 V AC

<sup>1)</sup> 3RW55 soft starter with screw terminals for operational voltage up to 480 V: Standard delivery time SD = 1 day (d).

**Note:**



For the constraints for the motor outputs specified here, see page 7/7.

### Selection and ordering data

Product designation	Manufacturer's Article No. of the soft starter	Type of product	Application	SD	Article No.	Price per PU	PU (UNIT, SET, M)	PS*		
<b>Fan covers</b>										
 3RW5983-0FC00	<b>Fan cover</b>	3RW551 (1x), 3RW552 (2x), 3RW553 (2x)	--	--	▶	<b>3RW5983-0FC00</b>	1	1 unit		
		3RW554 (1x)	--	--	▶	<b>3RW5984-0FC00</b>	1	1 unit		
<b>Terminal covers</b>										
 3RW5983-0TC20	<b>Terminal cover</b>	3RW552 (2x), 3RW553 (2x)	--	--	▶	<b>3RW5983-0TC20</b>	1	1 unit		
	 3RW5984-0TC20		3RW554 (2x)	--	--	▶	<b>3RW5984-0TC20</b>	1	1 unit	
<b>Enclosure components</b>										
 3RW5950-0GL20	<b>Hinged cover</b>	3RW55	Without cutout	--	▶	<b>3RW5950-0GL20</b>	1	1 unit		
<b>Communication modules</b>										
 3RW5980-0CS00	<b>Communication module</b>	3RW55	PROFINET High Feature with integral switch	--	▶	<b>3RW5950-0CH00</b>	1	1 unit		
				PROFINET Standard	--	▶	<b>3RW5980-0CS00</b>	1	1 unit	
					PROFIBUS	--	▶	<b>3RW5980-0CP00</b>	1	1 unit
					EtherNet/IP	--	▶	<b>3RW5980-0CE00</b>	1	1 unit
					Modbus RTU	--	▶	<b>3RW5980-0CR00</b>	1	1 unit
 3RW5980-0CE00					▶	<b>3RW5980-0CT00</b>	1	1 unit		
 3RW5980-0CR00					▶	<b>3RW5980-0CT00</b>	1	1 unit		

# High Performance Soft Starters

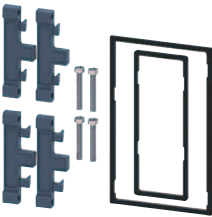
## 3RW55 Failsafe soft starters > Accessories

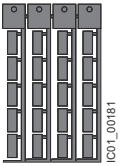
Product designation	Manufacturer's Article No. of the soft starter	Type of product	Application	SD	Article No.	Price per PU	PU (UNIT, SET, M)	PS*
<b>HMI modules</b>								
	<b>IP65 door mounting kit for HMI modules</b>	3RW55	IP65	For HMI modules	▶	<b>3RW5980-0HD00</b>	1	1 unit
3RW5980-0HD00								
<b>Connecting cables</b>								
	<b>HMI connection cable</b>	3RW55	5 m, round	For door mounting	▶	<b>3RW5980-0HC60</b>	1	1 unit
			2.5 m, round		▶	<b>3UF7933-0BA00-0</b>	1	1 unit
			1.0 m, round		▶	<b>3UF7937-0BA00-0</b>	1	1 unit
			0.5 m, round		▶	<b>3UF7932-0BA00-0</b>	1	1 unit
3UF793.-0BA00-0								
<b>Further accessories</b>								
	<b>Push-in lugs for wall mounting</b>	--	Two lugs are required per device	For HMI modules and communication modules	2	<b>3ZY1311-0AA00</b>	1	10 units
3ZY1311-0AA00								
<b>Blank labels</b>								
	<b>Unit labeling plates<sup>1)</sup></b>	--	20 mm x 7 mm, titanium gray	For SIRIUS devices	20	<b>3RT2900-1SB20</b>	100	340 units
3RT2900-1SB20								

<sup>1)</sup> PC labeling systems for individual inscription of unit labeling plates are available from: murrplastik Systemtechnik GmbH (see page 16/15).

# General Performance Soft Starters

3RW52 soft starters > General data

## Overview

### More information

Homepage, see [www.usa.siemens.com/soft-starter](http://www.usa.siemens.com/soft-starter)  
 Industry Mall, see [www.siemens.com/product?3RW52](http://www.siemens.com/product?3RW52)  
 TIA Selection Tool Cloud (TST Cloud), see <https://www.siemens.com/tstcloud/?node=3rw52>

Industry Online Support (SIOS) topic page, see <https://support.industry.siemens.com/cs/ww/en/view/109747404>  
 Simulation Tool for Soft Starters (STS), see page 7/7 or <https://support.industry.siemens.com/cs/ww/en/view/101494917>  
 SIRIUS Soft Starter ES (TIA Portal), see page 14/5



SIRIUS 3RW52 General Performance soft starters are the ideal solution for standard applications. With ideal three-phase motor control, they cover the performance range from 7.5 to 400HP @ 480V.

Optional HMI modules, plug-in communication modules (PROFINET, PROFIBUS, EtherNet/IP and Modbus) and either an analog output or thermistor motor protection ensure maximum flexibility. With their modern hybrid switching technology, the SIRIUS 3RW52 soft starters offer efficient switching for long-term, energy-saving use.

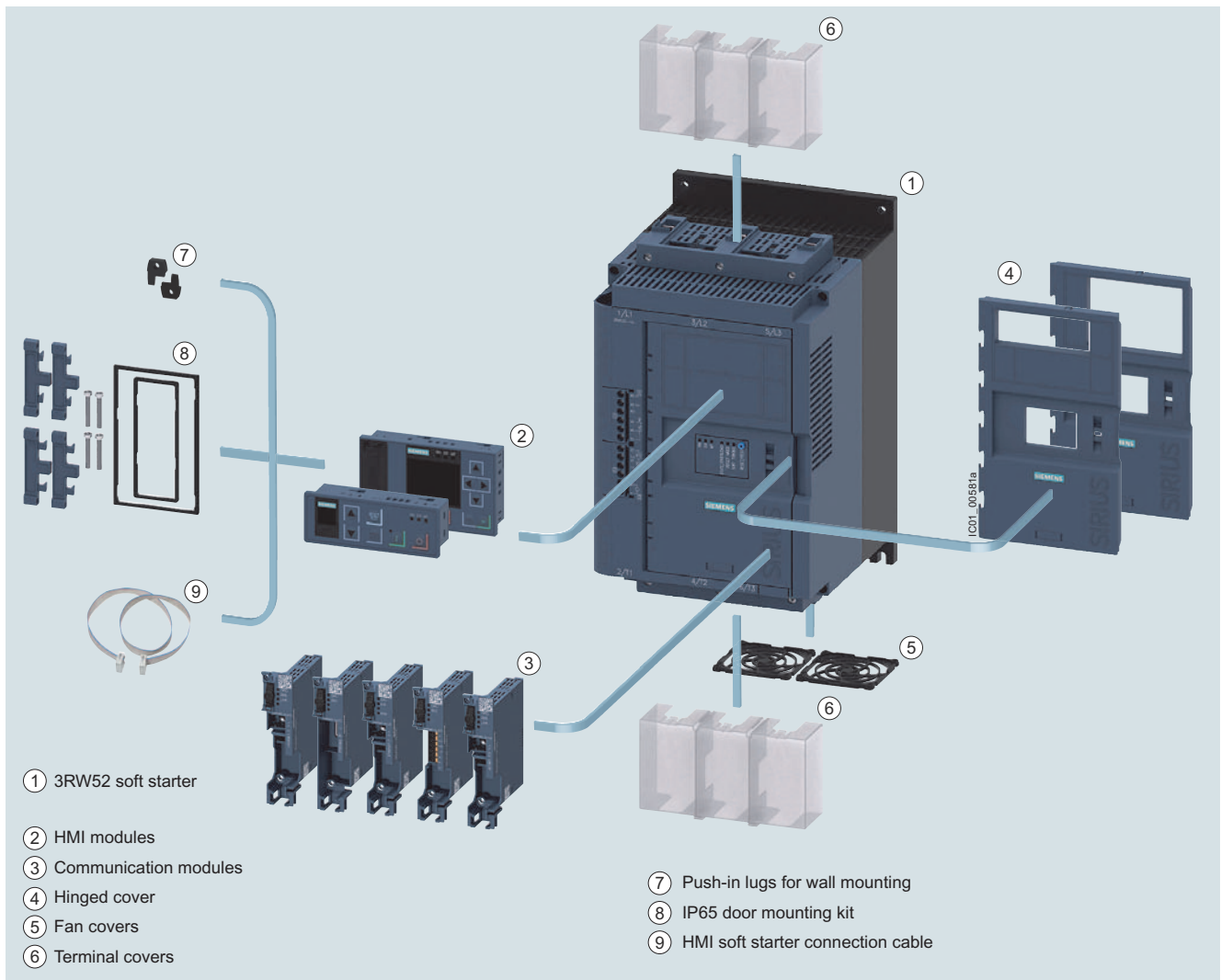

① 3RW52 soft starter

② HMI modules

③ Communication modules

④ Hinged cover

⑤ Fan covers

⑥ Terminal covers

⑦ Push-in lugs for wall mounting

⑧ IP65 door mounting kit

⑨ HMI soft starter connection cable

3RW52 General Performance soft starters with accessories (see page 7/69), for expansion with HMI module or communication module

# General Performance Soft Starters

3RW52 soft starters > General data

## Benefits

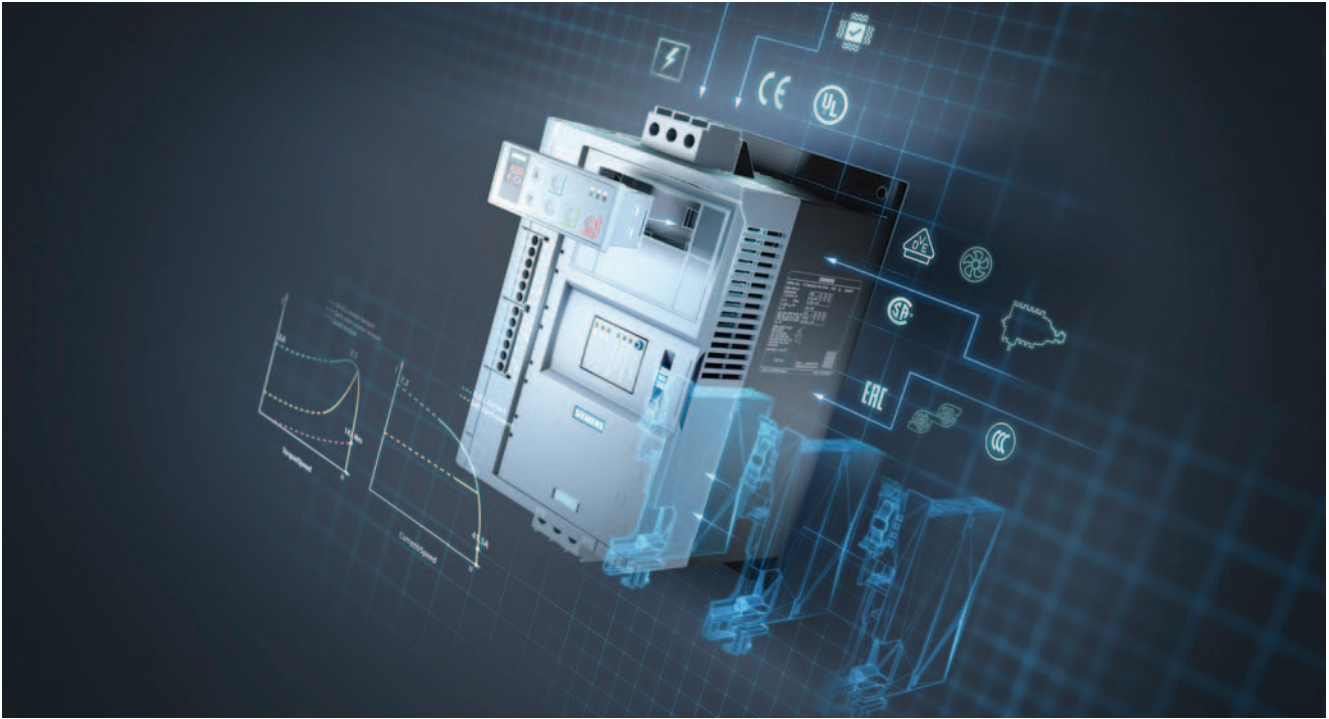

Product characteristics / function	Performance features / benefits
Hybrid switching devices and three-phase motor control	Minimum power loss and optimum/symmetrical motor control
TIA-Integration – communication modules and HMI modules optional	Efficient configuration and maximum flexibility in automation engineering
Soft Torque	Reduced mechanical loading and optimum pump stop
Parameterization using potentiometers	Simple and fast commissioning
Wide range for control supply and main voltage	Low variance, high system availability even with weak supply networks

## Technical specifications

## More information

Technical specifications, see <https://support.industry.siemens.com/cs/ww/en/ps/25100/td>  
 Equipment Manual "SIRIUS 3RW52 Soft Starter", see <https://support.industry.siemens.com/cs/ww/en/view/109753751>

FAQs, see <https://support.industry.siemens.com/cs/ww/en/ps/25100/faq>  
 Simulation Tool for Soft Starters (STS), see page 7/7 or <https://support.industry.siemens.com/cs/ww/en/view/101494917>

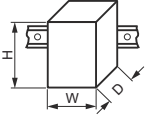
Type	3RW5213 3RW5214 3RW5215	3RW5216 3RW5217	3RW5224 3RW5225	3RW5226 3RW5227 3RW5234 3RW5235 3RW5236	3RW5243 3RW5244 3RW5245 3RW5246 3RW5247 3RW5248
<b>Installation/fixing/dimensions</b>					
Width x height x depth		mm 170 x 275 x 152	185 x 306 x 203	210 x 393 x 203	
Type of mounting	Screw fixing				
Mounting position	For vertical mounting surface can be rotated +/- 10° and tilted forward or backward	For vertical mounting surface can be rotated +/- 90°, for vertical mounting surface can be tilted +/- 22.5° forward or backward	For vertical mounting surface can be rotated +/- 10° and tilted forward or backward	For vertical mounting surface can be rotated +/- 90°, for vertical mounting surface can be tilted +/- 22.5° forward or backward	
<b>Distance to be maintained with side-by-side mounting</b>					
• Above	mm	100			
• At the side	mm	5			
• Below	mm	75			
Maximum installation altitude above sea level <sup>1)</sup>	m	5 000			
Degree of protection	IP00				
<b>Ambient conditions</b>					
<b>Ambient temperature</b>					
• During operation <sup>2)</sup>	°C	-25 ... +60			
• During storage and transport	°C	-40 ... +80			
<b>Environmental category according to IEC 60721</b>					
• During operation	3K6 (no ice formation, no condensation), 3C3 (no salt mist), 3S2 (sand must not get into the devices), 3M6				
• During storage	1K6 (only occasional condensation), 1C2 (no salt mist), 1S2 (sand must not enter the devices), 1M4				
• During transport	2K2, 2C1, 2S1, 2M2 (max. height of fall 0.3 m)				

<sup>1)</sup> Derating from 1 000 m, see characteristic curve on page 7/7.

<sup>2)</sup> Note derating above 40 °C.

## General Performance Soft Starters

## 3RW52 soft starters &gt; General data

Type		3RW52...-C0.	3RW52...-C1.
<b>Control circuit/control</b>			
<b>Control supply voltage</b>			
• At AC/DC, rated value	V	24/24	--/--
• At AC	V	--	110 ... 250
• Relative negative tolerance/relative positive tolerance with AC	%	-20/20	-15/10
• Relative negative tolerance/relative positive tolerance with DC	%	-20/20	--/--
<b>Frequency of the control supply voltage</b>			
• Relative negative tolerance/relative positive tolerance	Hz	50 ... 60	
	%	-10/10	
<b>Type of overvoltage protection</b>			
Varistors			
<b>Type of short-circuit protection for control circuit<sup>1)</sup></b>			
Fuse 4 A gG ( $I_{cu} = 1$ kA), fuse 6 A quick-response ( $I_{cu} = 1$ kA), MCB C1 ( $I_{cu} = 600$ A), MCB C6 ( $I_{cu} = 300$ A)			

<sup>1)</sup> Not included in scope of supply

Type		3RW52...-C.4	3RW52...-C.5
<b>Power electronics</b>			
<b>Operational voltage, rated value</b>			
• Relative negative tolerance/relative positive tolerance	V	200 ... 480	200 ... 600
	%	-15/10	
<b>Operational voltage for inside-delta circuit, rated value</b>			
• Relative negative tolerance/relative positive tolerance	V	200 ... 480	200 ... 600
	%	-15/10	
<b>Operating frequency, rated value</b>			
• Relative negative tolerance/relative positive tolerance	Hz	50 ... 60	
	%	-10/10	
<b>Minimum load [% of <math>I_M</math>]<sup>1)</sup></b>			
	%	15	
<b>Maximum cable length between soft starter and motor</b>			
	m	800	

<sup>1)</sup> Relative to the smallest adjustable  $I_e$ .



## General Performance Soft Starters

## 3RW52 soft starters &gt; General data

Type		3RW5213	3RW5214	3RW5215	3RW5216	3RW5217
<b>Rated operational current <math>I_e</math></b>	A	13	18	25	32	38
<b>Power electronics</b>						
<b>Load rating with rated operational current <math>I_e</math></b>						
IEC + UL/CSA, individual mounting at 40/50/60 °C, A AC-53a	A	13/11.5/10.5	18/15.9/13.8	25/22.3/19.6	32/28.4/26	38/33.5/30.5
<b>Permissible rated motor current and starts/h</b>						
<b>Normal starting (CLASS 10A)</b>						
Rated motor current $I_M$ , $T_U = 40/50/60$ °C ON period = 70%; motor protection activated	A	13/11.5/10.5	18/15.9/13.8	25/22.3/19.6	32/28.4/26	38/33.5/30.5
• 300% $I_M$						
- Start-up time 5 s	1/h	43	43	43	43	43
- Start-up time 10 s	1/h	18	18	18	18	18
• 350% $I_M$						
- Start-up time 5 s	1/h	28	28	28	28	28
- Start-up time 10 s	1/h	10	10	10	10	10
<b>Normal starting (CLASS 10E)</b>						
Rated motor current $I_M$ , $T_U = 40/50/60$ °C ON period = 70%; motor protection activated	A	13/11.5/10.5	18/15.9/13.8	25/22.3/19.6	32/28.4/26	38/33.5/30.5
• 300% $I_M$						
- Start-up time 20 s	1/h	21	21	21	21	21
- Start-up time 40 s	1/h	8	8	8	8	8
• 350% $I_M$						
- Start-up time 20 s	1/h	13	13	13	13	13
- Start-up time 40 s	1/h	4	4	4	4	4
<b>Heavy starting (CLASS 20E)</b>						
Rated motor current $I_M$ , $T_U = 40/50/60$ °C ON period = 70%; motor protection activated	A	13/11.5/10.5	18/15.9/13.8	25/22.3/19.6	29.6/27.2/23.6	33.5/30.5/27.5
• 300% $I_M$						
- Start-up time 20 s	1/h	10	10	10	10	10
- Start-up time 40 s	1/h	4	4	4	4	4
• 350% $I_M$						
- Start-up time 20 s	1/h	7	7	7	7	7
- Start-up time 40 s	1/h	2.5	2.5	2.5	2.5	2.5
<b>Adjustable rated motor current <math>I_M</math></b>						
• Minimum/maximum	A	5.5/13	7.5/18	11.5/25	14/32	15.5/38
• Minimum/maximum in inside-delta circuits	A	9.5/22.5	13/31.2	19.9/43.3	24.2/55.4	26.8/65.8

## General Performance Soft Starters

## 3RW52 soft starters &gt; General data

Type		3RW5224	3RW5225	3RW5226	3RW5227
<b>Rated operational current <math>I_e</math></b>	A	47	63	77	93
<b>Power electronics</b>					
<b>Load rating with rated operational current <math>I_e</math></b>					
IEC + UL/CSA, individual mounting at 40/50/60 °C, A AC-53a		47/41.6/36.2	63/55.5/50.5	77/68/62	93/82.5/75.5
<b>Permissible rated motor current and starts/h</b>					
<b>Normal starting (CLASS 10A)</b>					
Rated motor current $I_M$ , $T_U = 40/50/60$ °C ON period = 70%; motor protection activated	A	47/41.6/36.2	63/55.5/50.5	77/68/62	93/82.5/75.5
• 300% $I_M$					
- Start-up time 5 s	1/h	43	43	43	43
- Start-up time 10 s	1/h	18	18	18	18
• 350% $I_M$					
- Start-up time 5 s	1/h	28	28	28	28
- Start-up time 10 s	1/h	10	10	10	10
<b>Normal starting (CLASS 10E)</b>					
Rated motor current $I_M$ , $T_U = 40/50/60$ °C ON period = 70%; motor protection activated	A	47/41.6/36.2	63/55.5/50.5	77/68/62	93/82.5/75.5
• 300% $I_M$					
- Start-up time 20 s	1/h	21	21	21	21
- Start-up time 40 s	1/h	8	8	8	8
• 350% $I_M$					
- Start-up time 20 s	1/h	13	13	13	13
- Start-up time 40 s	1/h	4	4	4	4
<b>Heavy starting (CLASS 20E)</b>					
Rated motor current $I_M$ , $T_U = 40/50/60$ °C ON period = 70%; motor protection activated	A	47/41.6/36.2	63/55.5/50.5	65/59/53	93/82.5/75.5
• 300% $I_M$					
- Start-up time 20 s	1/h	10	10	10	10
- Start-up time 40 s	1/h	4	3	4	4
• 350% $I_M$					
- Start-up time 20 s	1/h	7	4	7	7
- Start-up time 40 s	1/h	2	0	2.5	2.5
<b>Adjustable rated motor current <math>I_M</math></b>					
• Minimum/maximum	A	20/47	25.5/63	32/77	40.5/93
• Minimum/maximum in inside-delta circuits	A	34.6/81.4	44.2/109	55.4/133	70.1/161

## General Performance Soft Starters

## 3RW52 soft starters &gt; General data

Type		3RW5234	3RW5235	3RW5236
<b>Rated operational current <math>I_e</math></b>	A	113	143	171
<b>Power electronics</b>				
<b>Load rating with rated operational current <math>I_e</math></b>				
IEC + UL/CSA, individual mounting at 40/50/60 °C, AC-53a	A	113/101/89	143/128/118	171/153/141
<b>Permissible rated motor current and starts/h</b>				
<b>Normal starting (CLASS 10A)</b>				
Rated motor current $I_M$ , $T_U = 40/50/60$ °C ON period = 70%; motor protection activated	A	113/101/89	143/128/118	171/153/141
• 300% $I_M$				
- Start-up time 5 s	1/h	43	43	43
- Start-up time 10 s	1/h	18	18	18
• 350% $I_M$				
- Start-up time 5 s	1/h	28	27	20
- Start-up time 10 s	1/h	10	8	4
<b>Normal starting (CLASS 10E)</b>				
Rated motor current $I_M$ , $T_U = 40/50/60$ °C ON period = 70%; motor protection activated	A	113/101/89	139/127/116	158/146/129
• 300% $I_M$				
- Start-up time 20 s	1/h	21	21	21
- Start-up time 40 s	1/h	8	8	8
• 350% $I_M$				
- Start-up time 20 s	1/h	13	12	12
- Start-up time 40 s	1/h	4	1	1
<b>Heavy starting (CLASS 20E)</b>				
Rated motor current $I_M$ , $T_U = 40/50/60$ °C ON period = 70%; motor protection activated	A	109/97/85	113/103/93	129/117/105
• 300% $I_M$				
- Start-up time 20 s	1/h	10	10	10
- Start-up time 40 s	1/h	4	4	4
• 350% $I_M$				
- Start-up time 20 s	1/h	7	7	7
- Start-up time 40 s	1/h	2.5	2.5	2.5
<b>Adjustable rated motor current <math>I_M</math></b>				
• Minimum/maximum	A	53/113	68/143	81/171
• Minimum/maximum in inside-delta circuits	A	91.8/196	118/248	140/296

## General Performance Soft Starters

## 3RW52 soft starters &gt; General data

Type		3RW5243	3RW5244	3RW5245	3RW5246	3RW5247	3RW5248
<b>Rated operational current <math>I_e</math></b>	A	210	250	315	370	470	570
<b>Power electronics</b>							
<b>Load rating with rated operational current <math>I_e</math></b>							
IEC + UL/CSA, individual mounting at 40/50/60 °C, A AC-53a		210/186/170	250/220/200	315/279/255	370/328/300	470/416/380	570/504/460
<b>Permissible rated motor current and starts/h</b>							
<b>Normal starting (CLASS 10A)</b>							
Rated motor current $I_M$ , $T_U = 40/50/60$ °C ON period = 70%; motor protection activated	A	210/186/170	250/220/200	315/279/255	370/328/300	470/416/380	570/504/460
• 300% $I_M$							
- Start-up time 5 s	1/h	43	43	43	43	30	20
- Start-up time 10 s	1/h	18	18	14	18	11	6
• 350% $I_M$							
- Start-up time 5 s	1/h	28	28	16	28	17	9
- Start-up time 10 s	1/h	5	10	4	10	5	1
<b>Normal starting (CLASS 10E)</b>							
Rated motor current $I_M$ , $T_U = 40/50/60$ °C ON period = 70%; motor protection activated	A	197/184/170	250/220/200	279/255/231	370/328/300	398/362/326	460/416/372
• 300% $I_M$							
- Start-up time 20 s	1/h	21	21	21	21	21	18
- Start-up time 40 s	1/h	8	8	8	8	8	7
• 350% $I_M$							
- Start-up time 20 s	1/h	12	13	12	13	13	11
- Start-up time 40 s	1/h	1	4	3	4	4	2
<b>Heavy starting (CLASS 20E)</b>							
Rated motor current $I_M$ , $T_U = 40/50/60$ °C ON period = 70%; motor protection activated	A	162/146/130	200/180/160	195/171/147	258/230/202	272/236/218	284/262/240
• 300% $I_M$							
- Start-up time 20 s	1/h	10	10	10	10	10	10
- Start-up time 40 s	1/h	4	4	4	4	4	4
• 350% $I_M$							
- Start-up time 20 s	1/h	7	7	7	7	7	7
- Start-up time 40 s	1/h	2.5	2.5	2.5	2.5	2.5	2.5
<b>Adjustable rated motor current <math>I_M</math></b>							
• Minimum/maximum	A	90/210	100/250	135/315	160/370	200/470	240/570
• Minimum/maximum in inside-delta circuits	A	156/364	173/433	234/546	277/641	346/814	416/987

# General Performance Soft Starters

## 3RW52 soft starters > General data

### Motor feeders according to IEC with 3RV2/3VA motor starter protectors/circuit breakers (without semiconductor protection)

Type of coordination "1", CLASS 10, short-circuit breaking capacity  $I_{q1}$  in kA, see table

**Note:**

For general recommendations for constructing motor feeders with soft starters, see page 7/9.

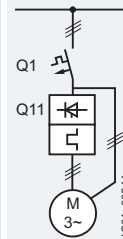
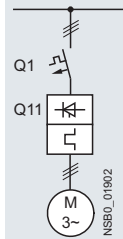

Soft starters	Motor starter protectors for 400 V systems				Motor starter protectors for 500 V systems			
	Q11 Type	$I_{q1}$ kA	Q1 Type	$I_{q1}$ kA	Q11 Type	$I_{q1}$ kA	Q1 Type	$I_{q1}$ kA
Type of coordination "1" <span style="border: 1px solid black; padding: 2px;">1</span>	<b>Inline circuit</b>				<b>Inside-delta circuit</b>			
<b>3RW5213</b>	3RV2032-4TA10	65	3RV2032-4TA10	18	3RV2032-4DA10	65	3RV2032-4DA10	18
<b>3RW5214</b>	3RV2032-4DA10	65	3RV2032-4DA10	15	3RV2032-4EA10	65	3RV2032-4EA10	15
<b>3RW5215</b>	3RV2032-4EA10	65	3RV2032-4EA10	15	3RV2032-4VA10	65	3RV2032-4VA10	15
<b>3RW5216</b>	3RV2032-4VA10	65	3RV2032-4VA10	10	3RV2032-4JA10	65	3RV2032-4JA10	10
<b>3RW5217</b>	3RV2032-4WA10	65	3RV2032-4WA10	10	3RV2032-4RA10	65	3RV2032-4RA10	10
<b>3RW5224</b>	3RV2032-4JA10	65	3RV2032-4JA10	10	3RV2032-4RA10	65	3RV2032-4RA10	10
<b>3RW5225</b>	3VA2163-7MN32-0AA0	65	3VA2163-7MN32-0AA0	20	3VA2110-7MN32-0AA0	65	3VA2110-7MN32-0AA0	20
<b>3RW5226</b>	3VA2110-7MN32-0AA0	65	3VA2110-7MN32-0AA0	20	3VA2216-7MN32-0AA0	65	3VA2216-7MN32-0AA0	20
<b>3RW5227</b>	3VA2216-7MN32-0AA0	15	3VA2216-7MN32-0AA0	10	3VA2220-7MN32-0AA0	15	3VA2220-7MN32-0AA0	10
<b>3RW5234</b>	3VA2216-7MN32-0AA0	65	--	--	3VA2220-7MN32-0AA0	65	--	--
<b>3RW5235</b>	3VA2220-7MN32-0AA0	65	--	--	3VA2325-7MN32-0AA0	65	--	--
<b>3RW5236</b>	3VA2325-7MN32-0AA0	30	3VA2325-7MN32-0AA0	10	3VA2440-7MN32-0AA0	30	3VA2440-7MN32-0AA0	10
<b>3RW5243</b>	3VA2325-7MN32-0AA0	65	3VA2325-7MN32-0AA0	65	3VA2440-7MN32-0AA0	65	3VA2440-7MN32-0AA0	65
<b>3RW5244</b>	3VA2440-7MN32-0AA0	65	3VA2440-7MN32-0AA0	65	3VA2450-7MN32-0AA0	65	3VA2450-7MN32-0AA0	65
<b>3RW5245</b>	3VA2440-7MN32-0AA0	65	3VA2440-7MN32-0AA0	65	3VA2580-6HN32-0AA0	65	3VA2580-6HN32-0AA0	65
<b>3RW5246</b>	3VA2440-7MN32-0AA0	65	3VA2440-7MN32-0AA0	65	3VA2580-6HN32-0AA0	65	3VA2580-6HN32-0AA0	65
<b>3RW5247</b>	3VA2450-7MN32-0AA0	65	3VA2450-7MN32-0AA0	65	3VA2510-6HN32-0AA0	65	3VA2510-6HN32-0AA0	65
<b>3RW5248</b>	3VA2580-6HN32-0AA0	65	3VA2580-6HN32-0AA0	65	3VA2510-6HN32-0AA0	65	3VA2510-6HN32-0AA0	65

**Note:**

The service factor or measurement inaccuracies have been taken into account, for example, for the selection of the specified motor starter protectors/circuit breakers; the specified short-circuit breaking capacities  $I_{q1}$  in kA are covered by combination tests. Smaller motor starter protectors/circuit breakers than those specified can be used at any time as smaller ones trip more quickly in the event of a short circuit (unchanged short-circuit breaking capacity) and thus protect the soft starter in any case. The dimensioning of the short-circuit components must, however, be suitable for the connected three-phase motor and the line protection for the cables used.

# General Performance Soft Starters

## 3RW52 soft starters > General data

### Motor feeders according to IEC with 3NA3 fuses

gG class full-range fuses for cable and line protection according to IEC 60269-2, without semiconductor protection

Type of coordination "1",  
short-circuit breaking capacity  $I_q = 65 \text{ kA}$

**Note:**

For general recommendations for constructing motor feeders with soft starters, see page 7/9.

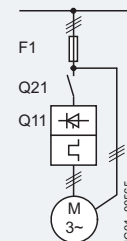
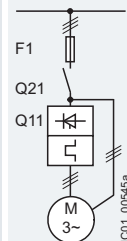
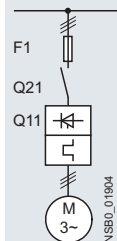

Soft starters	gG class fuse			Line contactor (optional)			gG class fuse			Line contactor (optional)					
	for systems up to 600 V			for systems up to 480 V		for systems up to 600 V	for systems up to 600 V			for systems up to 480 V in the supply cable		for systems up to 600 V in the supply cable	for systems up to 480 V in the delta	for systems up to 600 V in the delta	
Q11	F1			Q21		Q21	F1			Q21		Q21	Q21		Q21
Type	Type			Type		Type	Type			Type		Type	Type		Type
Type of coordination "1"	<b>Inline circuit</b>						<b>Inside-delta circuit</b>								
<b>3RW5213</b>	3NA3820-6			3RT2025		3RT2025	3NA3820-6			3RT2027		3RT2035	3RT2025		3RT2025
<b>3RW5214</b>	3NA3820-6			3RT2026		3RT2027	3NA3820-6			3RT2027		3RT2037	3RT2026		3RT2027
<b>3RW5215</b>	3NA3822-6			3RT2027		3RT2037	3NA3822-6			3RT2036		3RT2037	3RT2027		3RT2037
<b>3RW5216</b>	3NA3824-6			3RT2035		3RT2037	3NA3824-6			3RT2037		3RT2038	3RT2035		3RT2037
<b>3RW5217</b>	3NA3824-6			3RT2035		3RT2037	3NA3824-6			3RT2038		3RT2046	3RT2035		3RT2037
<b>3RW5224</b>	3NA3824-6			3RT2036		3RT2037	3NA3824-6			3RT2046		3RT2047	3RT2036		3RT2037
<b>3RW5225</b>	3NA3830-6			3RT2037		3RT2046	3NA3830-6			3RT2047		3RT2054	3RT2037		3RT2046
<b>3RW5226</b>	3NA3132-6			3RT2038		3RT2046	3NA3132-6			3RT1055		3RT1055	3RT2038		3RT2046
<b>3RW5227</b>	3NA3136-6			3RT2046		3RT2047	3NA3136-6			3RT1056		3RT1056	3RT2046		3RT2047
<b>3RW5234</b>	3NA3244-6			3RT1054		3RT1054	3NA3244-6			3RT1064		3RT1064	3RT1054		3RT1054
<b>3RW5235</b>	3NA3244-6			3RT1055		3RT1055	3NA3244-6			3RT1065		3RT1065	3RT1055		3RT1055
<b>3RW5236</b>	3NA3365-6			3RT1056		3RT1064	3NA3365-6			3RT1066		3RT1075	3RT1056		3RT1064
<b>3RW5243</b>	2 x 3NA3354-6			3RT1064		3RT1064	2 x 3NA3354-6			3RT1075		3RT1075	3RT1064		3RT1064
<b>3RW5244</b>	2 x 3NA3354-6			3RT1065		3RT1065	2 x 3NA3354-6			3RT1076		3RT1076	3RT1065		3RT1065
<b>3RW5245</b>	2 x 3NA3365-6			3RT1075		3RT1075	2 x 3NA3365-6			3TF68		3TF68	3RT1075		3RT1075
<b>3RW5246</b>	2 x 3NA3365-6			3RT1075		3RT1075	2 x 3NA3365-6			3TF69		3TF69	3RT1075		3RT1075
<b>3RW5247</b>	2 x 3NA3365-6			3RT1076		3RT1276	2 x 3NA3365-6			3TF69		3TF69	3RT1076		3RT1276
<b>3RW5248</b>	2 x 3NA3365-6			3TF68		3TF68	2 x 3NA3365-6			--		--	3TF68		3TF68

**Note:**

The specified short-circuit breaking capacities  $I_q$  in kA are covered by combination tests. Smaller fuses than those specified can be used at any time as smaller ones trip more quickly in the event of a short circuit (unchanged short-circuit breaking capacity) and thus protect the soft starter in any case. The dimensioning of the short-circuit components must, however, be suitable for the connected three-phase motor and the line protection for the cables used.

# General Performance Soft Starters

## 3RW52 soft starters > General data

### Motor feeders according to IEC with 3NE1 SITOR fuses

gR class full-range fuses for semiconductor protection, cable and line protection

Type of coordination "2",  
short-circuit breaking capacity  $I_q = 65 \text{ kA}$

**Note:**

For general recommendations for constructing motor feeders with soft starters, [see page 7/9](#).

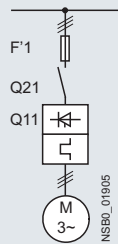

Soft starters	gG class fuse	Line contactor (optional)	
Q11	for systems up to 600 V	for systems up to 480 V	for systems up to 600 V
Type	F'1	Q21	Q21
Type	Type	Type	Type
Type of coordination "2"	Inline circuit		
<b>3RW5213</b>	3NE1815-0	3RT2025	3RT2025
<b>3RW5214</b>	3NE1802-0	3RT2026	3RT2027
<b>3RW5215</b>	3NE1817-0	3RT2027	3RT2037
<b>3RW5216</b>	3NE1818-0	3RT2035	3RT2037
<b>3RW5217</b>	3NE1820-0	3RT2035	3RT2037
<b>3RW5224</b>	3NE1021-2	3RT2036	3RT2037
<b>3RW5225</b>	3NE1022-0	3RT2037	3RT2046
<b>3RW5226</b>	3NE1224-0	3RT2038	3RT2046
<b>3RW5227</b>	3NE1224-0	3RT2046	3RT2047
<b>3RW5234</b>	3NE1225-0	3RT1054	3RT1054
<b>3RW5235</b>	3NE1227-0	3RT1055	3RT1055
<b>3RW5236</b>	3NE1230-0	3RT1056	3RT1064
<b>3RW5243</b>	3NE1230-2 <sup>1)</sup>	3RT1064	3RT1064
<b>3RW5244</b>	3NE1331-0	3RT1065	3RT1065
<b>3RW5245</b>	3NE1334-2	3RT1075	3RT1075
<b>3RW5246</b>	3NE1334-2	3RT1075	3RT1075
<b>3RW5247</b>	3NE1436-2	3RT1076	3RT1276
<b>3RW5248</b>	3NE1437-2	3TF68	3TF68

<sup>1)</sup> For systems up to 500 V.

**Note:**

The specified short-circuit breaking capacities  $I_q$  in kA are covered by combination tests. Smaller fuses than those specified can be used at any time as smaller ones trip more quickly in the event of a short circuit (unchanged short-circuit breaking capacity) and thus protect the soft starter in any case. The dimensioning of the short-circuit components must, however, be suitable for the connected three-phase motor and the line protection for the cables used.

In inside-delta circuits, a gR class full-range fuse could not provide the semiconductor protection of the delta-connected soft starter with a short-circuit breaking capacity that is adequate for practical use. In this case, we recommend using aR class partial-range fuses for semiconductor protection for type of coordination "2" ([see page 7/64](#)).

# General Performance Soft Starters

## 3RW52 soft starters > General data



### Motor feeders according to IEC with fuses 3NE8 / 3NE4 / 3NE3

aR class partial-range fuses for semiconductor protection

Type of coordination "2",  
short-circuit breaking capacity  $I_q = 65 \text{ kA}$

**Note:**

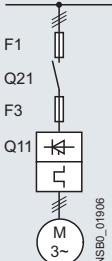
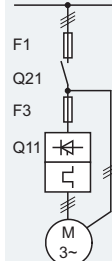
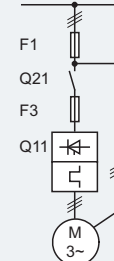
For general recommendations for constructing motor feeders with soft starters, see page 7/9.

Soft starters												
	gG class fuse	aR class fuse	Line contactor (optional)		gG class fuse	aR class fuse	Line contactor (optional)		gG class fuse	aR class fuse	Line contactor (optional)	
	for systems up to 600 V	for systems up to 500 V	for systems up to 480 V	for systems up to 600 V	for systems up to 600 V	for systems up to 600 V	for systems up to 480 V in the supply cable	for systems up to 600 V in the supply cable	for systems up to 480 V in the delta	for systems up to 600 V in the delta		
Q11	F1	F3	Q21	Q21	F1	F3	Q21	Q21	Q21	Q21		
Type	Type	Type	Type	Type	Type	Type	Type	Type	Type	Type		
Type of coordination "2"	 <b>Inline circuit</b>				<b>Inside-delta circuit</b>							
<b>3RW5213</b>	3NA3820-6	3NE8017-1	3RT2025	3RT2025	3NA3820-6	3NE8017-1	3RT2027	3RT2035	3RT2025	3RT2025		
<b>3RW5214</b>	3NA3820-6	3NE8020-1	3RT2026	3RT2027	3NA3820-6	3NE8020-1	3RT2027	3RT2037	3RT2026	3RT2027		
<b>3RW5215</b>	3NA3822-6	3NE8021-1	3RT2027	3RT2037	3NA3822-6	3NE8021-1	3RT2036	3RT2037	3RT2027	3RT2037		
<b>3RW5216</b>	3NA3824-6	3NE8022-1	3RT2035	3RT2037	3NA3824-6	3NE8022-1	3RT2037	3RT2038	3RT2035	3RT2037		
<b>3RW5217</b>	3NA3824-6	3NE8024-1	3RT2035	3RT2037	3NA3824-6	3NE8024-1	3RT2038	3RT2046	3RT2035	3RT2037		
<b>3RW5224</b>	3NA3824-6	3NE8024-1	3RT2036	3RT2037	3NA3824-6	3NE8024-1	3RT2046	3RT2047	3RT2036	3RT2037		
<b>3RW5225</b>	3NA3830-6	3NE8024-1	3RT2037	3RT2046	3NA3830-6	3NE8024-1	3RT2047	3RT1054	3RT2037	3RT2046		
<b>3RW5226</b>	3NA3132-6	3NE8024-1	3RT2038	3RT2046	3NA3132-6	3NE8024-1	3RT1055	3RT1055	3RT2038	3RT2046		
<b>3RW5227</b>	3NA3136-6	3NE4124	3RT2046	3RT2047	3NA3136-6	3NE4124	3RT1056	3RT1056	3RT2046	3RT2047		
<b>3RW5234</b>	3NA3244-6	3NE3332-0B	3RT1054	3RT1054	3NA3244-6	3NE3332-0B	3RT1064	3RT1064	3RT1054	3RT1054		
<b>3RW5235</b>	3NA3244-6	3NE3334-0B	3RT1055	3RT1055	3NA3244-6	3NE3334-0B	3RT1065	3RT1065	3RT1055	3RT1055		
<b>3RW5236</b>	3NA3365-6	3NE3335	3RT1056	3RT1064	3NA3365-6	3NE3335	3RT1066	3RT1075	3RT1056	3RT1064		
<b>3RW5243</b>	2 x 3NA3354-6	3NE3333	3RT1064	3RT1064	2 x 3NA3354-6	3NE3333	3RT1075	3RT1075	3RT1064	3RT1064		
<b>3RW5244</b>	2 x 3NA3354-6	3NE3336	3RT1065	3RT1065	2 x 3NA3354-6	3NE3336	3RT1076	3RT1076	3RT1065	3RT1065		
<b>3RW5245</b>	2 x 3NA3365-6	3NE3336	3RT1075	3RT1075	2 x 3NA3365-6	3NE3336	3TF68	3TF68	3RT1075	3RT1075		
<b>3RW5246</b>	2 x 3NA3365-6	3NE3336	3RT1075	3RT1075	2 x 3NA3365-6	3NE3336	3TF69	3TF69	3RT1075	3RT1075		
<b>3RW5247</b>	2 x 3NA3365-6	3NE3340-8	3RT1076	3RT1276	2 x 3NA3365-6	3NE3340-8	3TF69	3TF69	3RT1076	3RT1276		
<b>3RW5248</b>	2 x 3NA3365-6	3NE3340-8	3TF68	3TF68	2 x 3NA3365-6	3NE3340-8	--	--	3TF68	3TF68		

**Note:**

The specified short-circuit breaking capacities  $I_q$  in kA are covered by combination tests. Smaller fuses than those specified can be used at any time as smaller ones trip more quickly in the event of a short circuit (unchanged short-circuit breaking capacity) and thus protect the soft starter in any case. The dimensioning of the short-circuit components must, however, be suitable for the connected three-phase motor and the line protection for the cables used.

For CLASS 10 applications, as an alternative to the gG class full-range fuses for cable and line protection 3NA3 (F1), 3RV2/3VA motor starter protectors/circuit breakers can also be used, possibly with reduced short-circuit breaking capacity (see page 7/61). In these cases, optional line contactors can be dispensed with.



# General Performance Soft Starters

3RW52 soft starters > Inline circuit **IE3/IE4 ready**

## Selection and ordering data

**For normal starting (CLASS 10A)**



3RW521.



3RW522.



3RW523.



3RW524.

At 40 °C				At 50 °C				SD <sup>1)</sup>	Article No.	Price per PU	PU (UNIT, SET, M)	PS*
Operational current A	Operating power for three-phase motors			Operational current A	Rating [hp] for three-phase motors							
	At 230 V	At 400 V	At 500 V		At 200/208 V	At 220/230 V	At 460/480 V	At 575/600 V				
<b>Operational voltage 200 ... 480 V</b>												
13	3	5.5	--	11.5	2	3	7.5	--	5	3RW5213-□□□□4	1	1 unit
18	4	7.5	--	15.9	3	5	10	--	5	3RW5214-□□□□4	1	1 unit
25	5.5	11	--	22.3	5	7.5	15	--	5	3RW5215-□□□□4	1	1 unit
32	7.5	15	--	28.4	7.5	10	20	--	5	3RW5216-□□□□4	1	1 unit
38	11	18.5	--	33.5	10	10	20	--	5	3RW5217-□□□□4	1	1 unit
47	11	22	--	41.6	10	10	30	--	5	3RW5224-□□□□4	1	1 unit
63	18.5	30	--	55.5	15	20	40	--	5	3RW5225-□□□□4	1	1 unit
77	22	37	--	68	20	25	50	--	5	3RW5226-□□□□4	1	1 unit
93	22	45	--	82.5	25	30	60	--	5	3RW5227-□□□□4	1	1 unit

**Type of electrical connection for the control circuit**

- Screw terminals
- Spring-loaded terminals

**Product function**

- Analog output
- Thermistor motor protection

**Control supply voltage**

- 24 V AC/DC
- 110 ... 250 V AC

<sup>1)</sup> 3RW52 soft starter with screw terminals for operational voltage up to 480 V: Standard delivery time SD = 1 day (d).

**Note:**

For the constraints for the motor outputs specified here, see page 7/7.



At 40 °C				At 50 °C				SD <sup>1)</sup>	Article No.	Price per PU	PU (UNIT, SET, M)	PS*
Operational current A	Operating power for three-phase motors			Operational current A	Rating [hp] for three-phase motors							
	At 230 V	At 400 V	At 500 V		At 200/208 V	At 220/230 V	At 460/480 V	At 575/600 V				
<b>Operational voltage 200 ... 480 V</b>												
113	30	55	--	101	30	30	75	--	5	3RW5234-□□□□4	1	1 unit
143	37	75	--	128	40	40	100	--	5	3RW5235-□□□□4	1	1 unit
171	45	90	--	153	50	50	100	--	5	3RW5236-□□□□4	1	1 unit
210	55	110	--	186	60	60	150	--	5	3RW5243-□□□□4	1	1 unit
250	75	132	--	220	60	75	150	--	5	3RW5244-□□□□4	1	1 unit
315	90	160	--	279	75	100	200	--	5	3RW5245-□□□□4	1	1 unit
370	110	200	--	328	100	125	250	--	5	3RW5246-□□□□4	1	1 unit
470	132	250	--	416	150	150	350	--	5	3RW5247-□□□□4	1	1 unit
570	160	315	--	504	150	200	400	--	5	3RW5248-□□□□4	1	1 unit

**Type of electrical connection for the control circuit**

- Spring-loaded terminals
- Screw terminals

**Product function**

- Analog output
- Thermistor motor protection

**Control supply voltage**

- 24 V AC/DC
- 110 ... 250 V AC

<sup>1)</sup> 3RW52 soft starter with screw terminals for operational voltage up to 480 V: Standard delivery time SD = 1 day (d).

**Note:**

For the constraints for the motor outputs specified here, see page 7/7.



# General Performance Soft Starters

3RW52 soft starters > Inline circuit **IE3/IE4 ready**

**For normal starting (CLASS 10A)**



3RW521.



3RW522.



3RW523.



3RW524.

At 40 °C				At 50 °C				SD <sup>1)</sup>	Article No.	Price per PU	PU (UNIT, SET, M)	PS*	
Operational current	Operating power for three-phase motors			Operational current	Rating [hp] for three-phase motors								
	At 230 V	At 400 V	At 500 V		At 200/208 V	At 220/230 V	At 460/480 V	At 575/600 V					
A	kW	kW	kW	A	hp	hp	hp	hp	d				
<b>Operational voltage 200 ... 600 V</b>													
13	3	5.5	7.5	11.5	2	3	7.5	10	5	3RW5213-□□C□5		1	1 unit
18	4	7.5	11	15.9	3	5	10	10	5	3RW5214-□□C□5		1	1 unit
25	5.5	11	15	22.3	5	7.5	15	20	5	3RW5215-□□C□5		1	1 unit
32	7.5	15	18.5	28.4	7.5	10	20	25	5	3RW5216-□□C□5		1	1 unit
38	11	18.5	22	33.5	10	10	20	30	5	3RW5217-□□C□5		1	1 unit
47	11	22	30	41.6	10	10	30	40	5	3RW5224-□□C□5		1	1 unit
63	18.5	30	37	55.5	15	20	40	50	5	3RW5225-□□C□5		1	1 unit
77	22	37	45	68	20	25	50	60	5	3RW5226-□□C□5		1	1 unit
93	22	45	55	82.5	25	30	60	75	5	3RW5227-□□C□5		1	1 unit

**Type of electrical connection for the control circuit**

- Screw terminals
- Spring-loaded terminals

**Product function**

- Analog output
- Thermistor motor protection

**Control supply voltage**

- 24 V AC/DC
- 110 ... 250 V AC



**Note:**

For the constraints for the motor outputs specified here, see page 7/7.

<sup>1)</sup> 3RW52 soft starter with screw terminals for operational voltage up to 600 V: Standard delivery time SD = 2 days (d).

SOFT STARTERS 7

At 40 °C				At 50 °C				SD <sup>1)</sup>	Article No.	Price per PU	PU (UNIT, SET, M)	PS*	
Operational current	Operating power for three-phase motors			Operational current	Rating [hp] for three-phase motors								
	At 230 V	At 400 V	At 500 V		At 200/208 V	At 220/230 V	At 460/480 V	At 575/600 V					
A	kW	kW	kW	A	hp	hp	hp	hp	d				
<b>Operational voltage 200 ... 600 V</b>													
113	30	55	75	101	30	30	75	100	5	3RW5234-□□C□5		1	1 unit
143	37	75	90	128	40	40	100	125	5	3RW5235-□□C□5		1	1 unit
171	45	90	110	153	50	50	100	150	5	3RW5236-□□C□5		1	1 unit
210	55	110	132	186	60	60	150	150	5	3RW5243-□□C□5		1	1 unit
250	75	132	160	220	60	75	150	200	5	3RW5244-□□C□5		1	1 unit
315	90	160	200	279	75	100	200	250	5	3RW5245-□□C□5		1	1 unit
370	110	200	250	328	100	125	250	300	5	3RW5246-□□C□5		1	1 unit
470	132	250	315	416	150	150	350	450	5	3RW5247-□□C□5		1	1 unit
570	160	315	355	504	150	200	400	500	5	3RW5248-□□C□5		1	1 unit

**Type of electrical connection for the control circuit**

- Spring-loaded terminals
- Screw terminals

**Product function**

- Analog output
- Thermistor motor protection

**Control supply voltage**

- 24 V AC/DC
- 110 ... 250 V AC



**Note:**

For the constraints for the motor outputs specified here, see page 7/7.

<sup>1)</sup> 3RW52 soft starter with screw terminals for operational voltage up to 600 V: Standard delivery time SD = 2 days (d).

# General Performance Soft Starters

3RW52 soft starters > Inside-delta circuit **IE3/IE4 ready**

## Selection and ordering data

For normal starting (CLASS 10A)



3RW521.



3RW522.



3RW523.



3RW524.

At 40 °C for inside-delta circuit				At 50 °C for inside-delta circuit				SD <sup>1)</sup>	Article No.	Price per PU	PU (UNIT, SET, M)	PS*	
Operational current	Operating power for three-phase motors			Operational current	Rating [hp] for three-phase motors								
	At 230 V	At 400 V	At 500 V		At 200/208 V	At 220/230 V	At 460/480 V	At 575/600 V					
A	kW	kW	kW	A	hp	hp	hp	hp	d				
<b>Operational voltage 200 ... 480 V</b>													
22.5	5.5	<b>11</b>	--	19.9	5	5	<b>10</b>	--	5	3RW5213-□□□□4		1	1 unit
31.5	7.5	<b>15</b>	--	28	7.5	7.5	<b>20</b>	--	5	3RW5214-□□□□4		1	1 unit
43.3	11	<b>18.5</b>	--	39	10	10	<b>25</b>	--	5	3RW5215-□□□□4		1	1 unit
55.4	15	<b>22</b>	--	49	15	15	<b>30</b>	--	5	3RW5216-□□□□4		1	1 unit
65.8	18.5	<b>30</b>	--	58	15	20	<b>40</b>	--	5	3RW5217-□□□□4		1	1 unit
81.4	22	<b>45</b>	--	72	20	25	<b>50</b>	--	5	3RW5224-□□□□4		1	1 unit
109	30	<b>55</b>	--	96	30		<b>75</b>	--	5	3RW5225-□□□□4		1	1 unit
133	37	<b>75</b>	--	118	30	40	<b>75</b>	--	5	3RW5226-□□□□4		1	1 unit
161	45	<b>90</b>	--	143	40	50	<b>100</b>	--	5	3RW5227-□□□□4		1	1 unit

**Type of electrical connection for the control circuit**

- Screw terminals
- Spring-loaded terminals

**Product function**

- Analog output
- Thermistor motor protection

**Control supply voltage**

- 24 V AC/DC
- 110 ... 250 V AC



**Note:**

For the constraints for the motor outputs specified here, see page 7/7.

<sup>1)</sup> 3RW52 soft starter with screw terminals for operational voltage up to 480 V: Standard delivery time SD = 1 day (d).

At 40 °C for inside-delta circuit				At 50 °C for inside-delta circuit				SD <sup>1)</sup>	Article No.	Price per PU	PU (UNIT, SET, M)	PS*	
Operational current	Operating power for three-phase motors			Operational current	Rating [hp] for three-phase motors								
	At 230 V	At 400 V	At 500 V		At 200/208 V	At 220/230 V	At 460/480 V	At 575/600 V					
A	kW	kW	kW	A	hp	hp	hp	hp	d				
<b>Operational voltage 200 ... 480 V</b>													
196	55	<b>110</b>	--	175	50	60	<b>125</b>	--	5	3RW5234-□□□□4		1	1 unit
248	75	<b>132</b>	--	222	75	75	<b>150</b>	--	5	3RW5235-□□□□4		1	1 unit
296	90	<b>160</b>	--	265	75	100	<b>200</b>	--	5	3RW5236-□□□□4		1	1 unit
364	110	<b>200</b>	--	322	100	125	<b>250</b>	--	5	3RW5243-□□□□4		1	1 unit
433	132	<b>250</b>	--	381	125	150	<b>300</b>	--	5	3RW5244-□□□□4		1	1 unit
546	160	<b>315</b>	--	483	150	200	<b>400</b>	--	5	3RW5245-□□□□4		1	1 unit
641	200	<b>355</b>	--	568	200	200	<b>450</b>	--	5	3RW5246-□□□□4		1	1 unit
814	250	<b>400</b>	--	721	250	250	<b>600</b>	--	5	3RW5247-□□□□4		1	1 unit
987	315	<b>560</b>	--	873	300	350	<b>750</b>	--	5	3RW5248-□□□□4		1	1 unit

**Type of electrical connection for the control circuit**

- Spring-loaded terminals
- Screw terminals

**Product function**

- Analog output
- Thermistor motor protection

**Control supply voltage**

- 24 V AC/DC
- 110 ... 250 V AC



**Note:**

For the constraints for the motor outputs specified here, see page 7/7.

<sup>1)</sup> 3RW52 soft starter with screw terminals for operational voltage up to 480 V: Standard delivery time SD = 1 day (d).

# General Performance Soft Starters

3RW52 soft starters > Inside-delta circuit **IE3/IE4 ready**

## For normal starting (CLASS 10A)



3RW521.



3RW522.



3RW523.



3RW524.

At 40 °C for inside-delta circuit				At 50 °C for inside-delta circuit				SD <sup>1)</sup>	Article No.	Price per PU	PU (UNIT, SET, M)	PS*
Operational current	Operating power for three-phase motors			Operational current	Rating [hp] for three-phase motors			d				
	At 230 V	At 400 V	At 500 V		At 200/208 V	At 220/230 V	At 460/480 V					
A	kW	kW	kW	A	hp	hp	hp	hp				
<b>Operational voltage 200 ... 600 V</b>												
22.5	5.5	<b>11</b>	15	19.9	5	5	<b>10</b>	15	5	<b>3RW5213-□□C□5</b>	1	1 unit
31.5	7.5	<b>15</b>	18.5	28	7.5	7.5	<b>20</b>	25	5	<b>3RW5214-□□C□5</b>	1	1 unit
43.3	11	<b>18.5</b>	22	39	10	10	<b>25</b>	30	5	<b>3RW5215-□□C□5</b>	1	1 unit
55.4	15	<b>22</b>	30	49	15	15	<b>30</b>	40	5	<b>3RW5216-□□C□5</b>	1	1 unit
65.8	18.5	<b>30</b>	37	58	15	20	<b>40</b>	50	5	<b>3RW5217-□□C□5</b>	1	1 unit
81.4	22	<b>45</b>	45	72	20	25	<b>50</b>	60	5	<b>3RW5224-□□C□5</b>	1	1 unit
109	30	<b>55</b>	55	96	30	30	<b>75</b>	75	5	<b>3RW5225-□□C□5</b>	1	1 unit
133	37	<b>75</b>	90	118	30	40	<b>75</b>	100	5	<b>3RW5226-□□C□5</b>	1	1 unit
161	45	<b>90</b>	110	143	40	50	<b>100</b>	125	5	<b>3RW5227-□□C□5</b>	1	1 unit

**Type of electrical connection for the control circuit**

- Screw terminals
- Spring-loaded terminals

**Product function**

- Analog output
- Thermistor motor protection

**Control supply voltage**

- 24 V AC/DC
- 110 ... 250 V AC



**Note:**

For the constraints for the motor outputs specified here, see page 7/7.

<sup>1)</sup> 3RW52 soft starter with screw terminals for operational voltage up to 600 V: Standard delivery time SD = 2 days (d).

At 40 °C for inside-delta circuit				At 50 °C for inside-delta circuit				SD <sup>1)</sup>	Article No.	Price per PU	PU (UNIT, SET, M)	PS*
Operational current	Operating power for three-phase motors			Operational current	Rating [hp] for three-phase motors			d				
	At 230 V	At 400 V	At 500 V		At 200/208 V	At 220/230 V	At 460/480 V					
A	kW	kW	kW	A	hp	hp	hp	hp				
<b>Operational voltage 200 ... 600 V</b>												
196	55	<b>110</b>	132	175	50	60	<b>125</b>	150	5	<b>3RW5234-□□C□5</b>	1	1 unit
248	75	<b>132</b>	160	222	75	75	<b>150</b>	200	5	<b>3RW5235-□□C□5</b>	1	1 unit
296	90	<b>160</b>	200	265	75	100	<b>200</b>	250	5	<b>3RW5236-□□C□5</b>	1	1 unit
364	110	<b>200</b>	250	322	100	125	<b>250</b>	300	5	<b>3RW5243-□□C□5</b>	1	1 unit
433	132	<b>250</b>	315	381	125	150	<b>300</b>	350	5	<b>3RW5244-□□C□5</b>	1	1 unit
546	160	<b>315</b>	355	483	150	200	<b>400</b>	500	5	<b>3RW5245-□□C□5</b>	1	1 unit
641	200	<b>355</b>	450	568	200	200	<b>450</b>	600	5	<b>3RW5246-□□C□5</b>	1	1 unit
814	250	<b>400</b>	500	721	250	250	<b>600</b>	800	5	<b>3RW5247-□□C□5</b>	1	1 unit
987	315	<b>560</b>	630	873	300	350	<b>750</b>	950	5	<b>3RW5248-□□C□5</b>	1	1 unit

**Type of electrical connection for the control circuit**

- Spring-loaded terminals
- Screw terminals

**Product function**

- Analog output
- Thermistor motor protection

**Control supply voltage**

- 24 V AC/DC
- 110 ... 250 V AC



**Note:**

For the constraints for the motor outputs specified here, see page 7/7.

<sup>1)</sup> 3RW52 soft starter with screw terminals for operational voltage up to 600 V: Standard delivery time SD = 2 days (d).

# General Performance Soft Starters





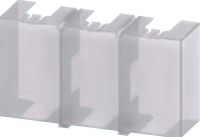

## 3RW52 soft starters > Accessories

### Selection and ordering data

Product designation	Manufacturer's Article No. of the soft starter	Type of product	Application	SD	Article No.	Price per PU	PU (UNIT, SET, M)	PS*
<b>Fan covers</b>								
 3RW5983-0FC00	<b>Fan cover</b>	3RW5216/17 (1x), 3RW5226/27 (2x), 3RW523 (2x)	--	--	▶	<b>3RW5983-0FC00</b>	1	1 unit
		3RW524 (1x)	--	--	▶	<b>3RW5984-0FC00</b>	1	1 unit
<b>Terminal covers</b>								
 3RW5983-0TC20	<b>Terminal cover</b>	3RW522 (2x), 3RW523 (2x)	--	--	▶	<b>3RW5983-0TC20</b>	1	1 unit
		3RW524 (2x)	--	--	▶	<b>3RW5984-0TC20</b>	1	1 unit
 3RW5984-0TC20								
<b>Enclosure components</b>								
 3RW5950-0GL30	<b>Hinged cover</b>	3RW52	With cutout for High Feature HMI module	--	▶	<b>3RW5950-0GL30</b>	1	1 unit
 3RW5950-0GL40			With cutout for Standard HMI module	--	▶	<b>3RW5950-0GL40</b>	1	1 unit
<b>Communication modules</b>								
 3RW5980-0CS00	<b>Communication module</b>	3RW52	PROFINET Standard	--	▶	<b>3RW5980-0CS00</b>	1	1 unit
			PROFIBUS	--	▶	<b>3RW5980-0CP00</b>	1	1 unit
			EtherNet/IP	--	▶	<b>3RW5980-0CE00</b>	1	1 unit
 3RW5980-0CR00			Modbus RTU	--	▶	<b>3RW5980-0CR00</b>	1	1 unit
			Modbus TCP	--	▶	<b>3RW5980-0CT00</b>	1	1 unit

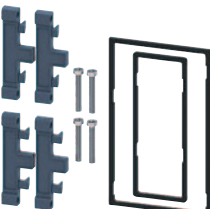
# General Performance Soft Starters

## 3RW52 soft starters > Accessories

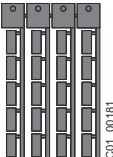
Product designation	Manufacturer's Article No. of the soft starter	Type of product	Application	SD	Article No.	Price per PU	PU (UNIT, SET, M)	PS*
<b>HMI modules</b>								
	<b>HMI module</b>	3RW52	High Feature	--	▶	<b>3RW5980-0HF00</b>	1	1 unit
3RW5980-0HF00			Standard	--	▶	<b>3RW5980-0HS00</b>	1	1 unit
								
3RW5980-0HS00								
	<b>IP65 door mounting kit for HMI modules</b>	3RW52	IP65	For HMI modules	▶	<b>3RW5980-0HD00</b>	1	1 unit
3RW5980-0HD00								
<b>Connecting cables</b>								
	<b>HMI connection cable</b>	3RW52	5 m, round 2.5 m, round 1.0 m, round 0.5 m, round	For door mounting	▶	<b>3RW5980-0HC60</b>	1	1 unit
3UF793.-0BA00-0					▶	<b>3UF7933-0BA00-0</b>	1	1 unit
					▶	<b>3UF7937-0BA00-0</b>	1	1 unit
					▶	<b>3UF7932-0BA00-0</b>	1	1 unit
			0.1 m, flat	for mounting in the device	▶	<b>3UF7931-0AA00-0</b>	1	1 unit
3UF7931-0AA00-0								
<b>Further accessories</b>								
	<b>Push-in lugs for wall mounting</b>	--	Two lugs are required per device	For HMI modules and communication modules	2	<b>3ZY1311-0AA00</b>	1	10 units
3ZY1311-0AA00								
<b>Blank labels</b>								
	<b>Unit labeling plates<sup>1)</sup></b>	--	20 mm x 7 mm, titanium gray	For SIRIUS devices	20	<b>3RT2900-1SB20</b>	100	340 units
3RT2900-1SB20								

<sup>1)</sup> PC labeling systems for individual inscription of unit labeling plates are available from: murrplastik Systemtechnik GmbH (see page 16/15).

# Basic Performance Soft Starters

3RW50 soft starters > General data **NEW**

## Overview

### More information

Homepage, see [www.usa.siemens.com/soft-starter](http://www.usa.siemens.com/soft-starter)  
 Industry Mall, see [www.siemens.com/product?3RW50](http://www.siemens.com/product?3RW50)  
 TIA Selection Tool Cloud (TST Cloud), see <https://support.industry.siemens.com/cs/ww/en/view/109747404>

Simulation Tool for Soft Starters (STS), see page 7/7 or <https://support.industry.siemens.com/cs/ww/en/view/101494917>  
 SIRIUS Soft Starter ES (TIA Portal), see page 14/5



SIRIUS 3RW50 Basic Performance soft starters are the compact solution for standard applications. With two-phase motor control, they cover the performance range from 75 to 300HP @ 480V.

Optional HMI modules for installation in the control cabinet door, laterally mountable communication modules (PROFINET, PROFIBUS, EtherNet/IP and Modbus) and either an analog output or thermistor motor protection ensure maximum flexibility. With their modern hybrid switching technology, the SIRIUS 3RW50 soft starters offer efficient switching for long-term, energy-saving use.

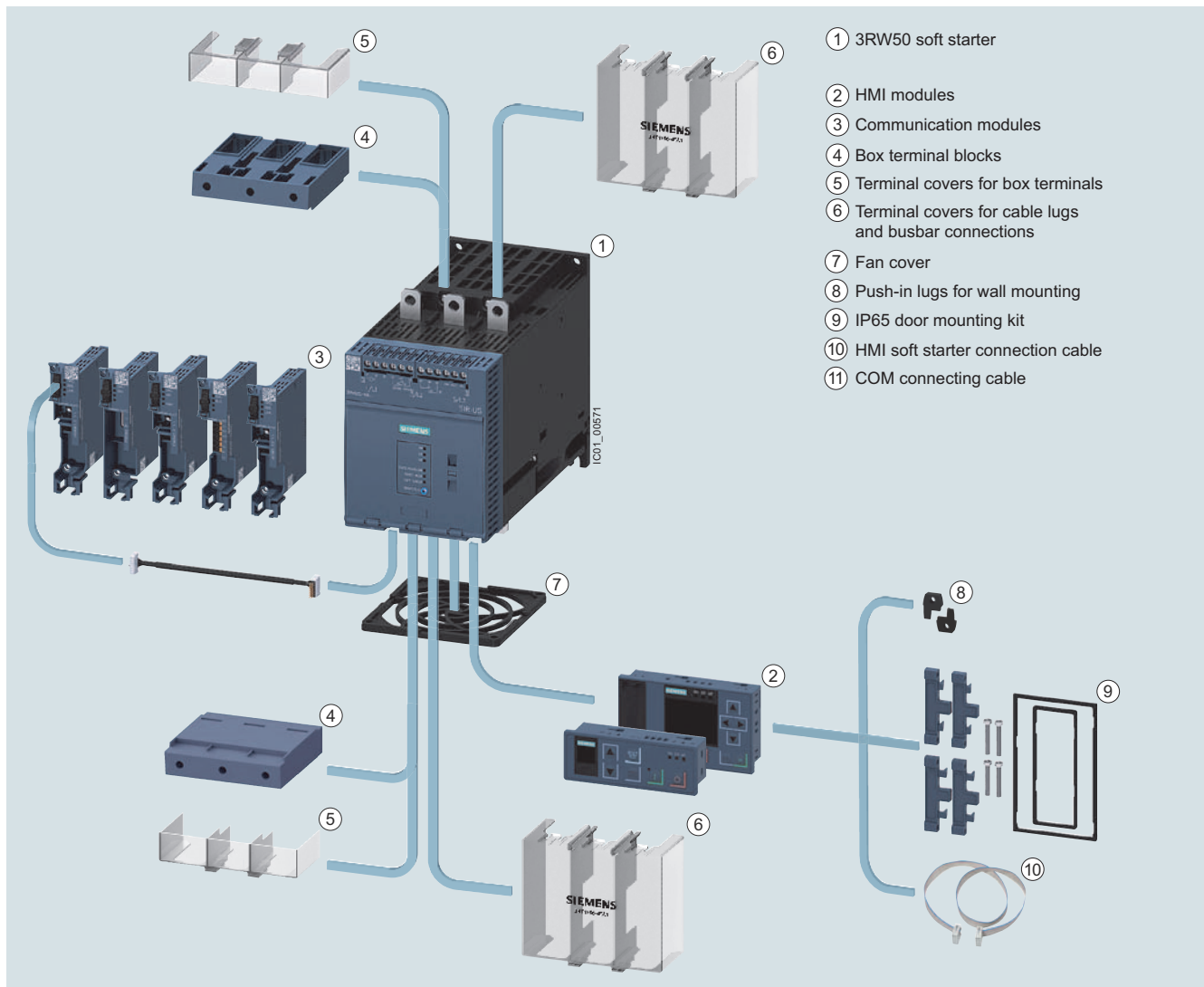

- ① 3RW50 soft starter
- ② HMI modules
- ③ Communication modules
- ④ Box terminal blocks
- ⑤ Terminal covers for box terminals
- ⑥ Terminal covers for cable lugs and busbar connections
- ⑦ Fan cover
- ⑧ Push-in lugs for wall mounting
- ⑨ IP65 door mounting kit
- ⑩ HMI soft starter connection cable
- ⑪ COM connecting cable

3RW50 Basic Performance soft starters with accessories (see page 7/81), for expansion with HMI module or communication module

# Basic Performance Soft Starters

3RW50 soft starters > General data **NEW**

## Benefits

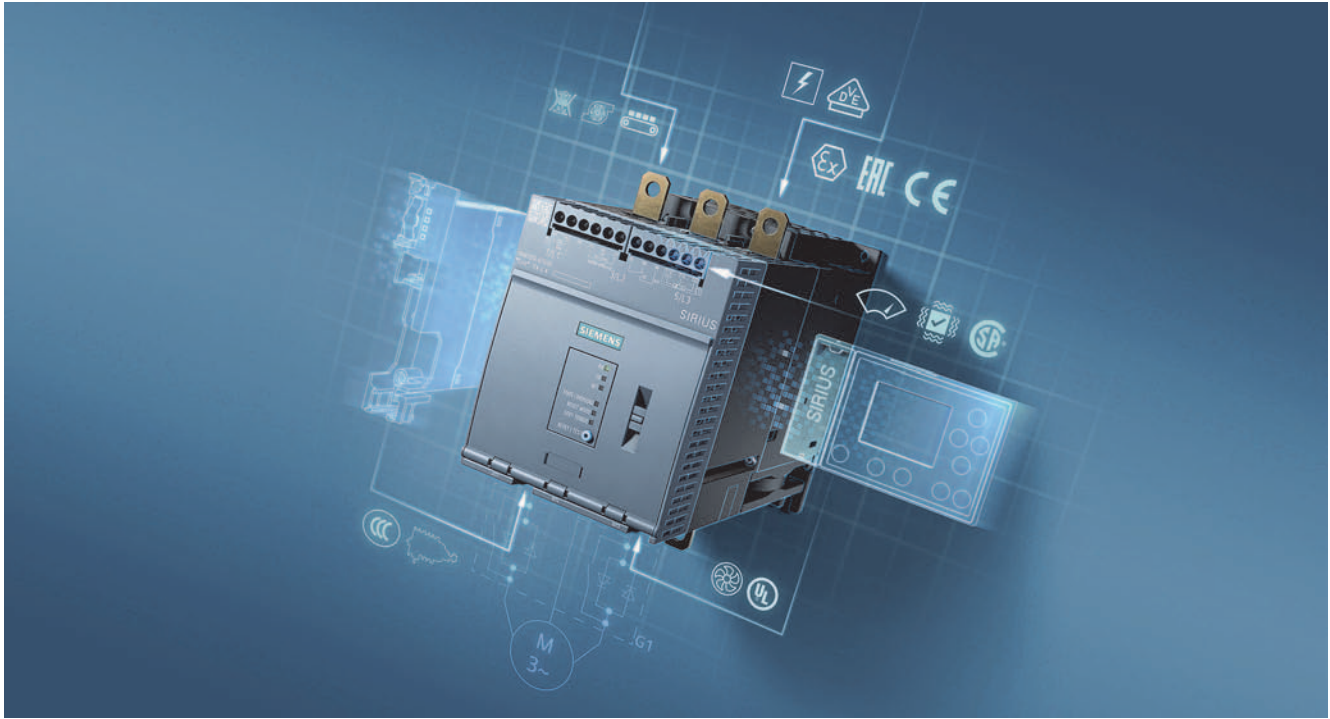

Product characteristics / function	Performance features / benefits
Hybrid switching devices and two-phase motor control	Minimum power loss and optimized motor control by avoiding DC components
Small and compact design	Space-saving, clearly arranged control panel layout
TIA-Integration – communication modules and HMI modules optional	Efficient configuration and maximum flexibility in automation engineering
Motor overload and intrinsic device protection without additional wiring	Adjustable trip classes, integrated diagnostics functions
Soft Torque	Reduced mechanical loading and optimum pump stop
Parameterization using potentiometers	Simple and fast commissioning
Wide range for control supply and main voltage	Low variance, high system availability even with weak supply networks
Certified according to ATEX/IECEX directive	Suitable for the starting of explosion-proof motors with "increased safety" type of protection



## Technical specifications

## More information

Technical specifications, see <https://support.industry.siemens.com/cs/ww/en/ps/25252/td>  
Equipment Manual "SIRIUS 3RW50 Soft Starter", see <https://support.industry.siemens.com/cs/ww/en/view/109753750>

FAQs, see <https://support.industry.siemens.com/cs/ww/en/ps/25252/faq>  
Simulation Tool for Soft Starters (STS), see page 7/7 or <https://support.industry.siemens.com/cs/ww/en/view/101494917>

Type	3RW5055 3RW5056	3RW5072 3RW5073 3RW5074 3RW5075 3RW5076 3RW5077
------	--------------------	--

## Installation/fixing/dimensions

## Width x height x depth

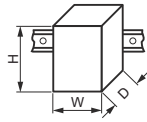

mm 120 × 198 × 249

160 × 230 × 282

## Type of mounting

Screw fixing

## Mounting position

For vertical mounting surface can be rotated +/- 90°,  
for vertical mounting surface can be tilted +/- 22.5° forward or backward

## Distance to be maintained with side-by-side mounting

- Above mm 100
- At the side mm 5
- Below mm 75

Maximum installation altitude above sea level<sup>1)</sup>

m 5 000

## Degree of protection

IP00

## Ambient conditions

## Ambient temperature

- During operation<sup>2)</sup> °C -25 ... +60
- During storage and transport °C -40 ... +80

## Environmental category according to IEC 60721

- During operation 3K6 (no ice formation, only occasional condensation), 3C3 (no salt mist), 3S2 (sand must not get into the devices), 3M6
- During storage 1K6 (only occasional condensation), 1C2 (no salt mist), 1S2 (sand must not enter the devices), 1M4
- During transport 2K2, 2C1, 2S1, 2M2 (max. height of fall 0,3 m)

<sup>1)</sup> Derating from 1 000 m, see characteristic curve on page 7/7.

<sup>2)</sup> Note derating above 40 °C.

## Basic Performance Soft Starters

3RW50 soft starters > General data **NEW**

Type		3RW50...-B0.	3RW50...-B1.
<b>Control circuit/control</b>			
<b>Control supply voltage</b>			
• At AC/DC, rated value	V	24/24	--/--
• At AC	V	--	110 ... 250
• Relative negative tolerance/relative positive tolerance with AC	%	-20/20	-15/10
• Relative negative tolerance/relative positive tolerance with DC	%	-20/20	--/--
<b>Frequency of the control supply voltage</b>			
• Relative negative tolerance/relative positive tolerance	Hz	50 ... 60	
	%	-10/10	
<b>Type of overvoltage protection</b>			
Varistors			
<b>Type of short-circuit protection for control circuit<sup>1)</sup></b>			
Fuse 4 A gG ( $I_{cu} = 1$ kA), fuse 6 A quick-response ( $I_{cu} = 1$ kA), MCB C1 ( $I_{cu} = 600$ A), MCB C6 ( $I_{cu} = 300$ A)			

<sup>1)</sup> Not included in scope of supply

Type		3RW50...-B.4	3RW50...-B.5
<b>Power electronics</b>			
<b>Operational voltage, rated value</b>			
• Relative negative tolerance/relative positive tolerance	V	200 ... 480	200 ... 600
	%	-15/10	
<b>Operating frequency, rated value</b>			
• Relative negative tolerance/relative positive tolerance	Hz	50 ... 60	
	%	-10/10	
<b>Minimum load [% of <math>I_M</math>]<sup>1)</sup></b>			
	%	15	
<b>Maximum cable length between soft starter and motor</b>			
	m	800	

<sup>1)</sup> Relative to the smallest adjustable  $I_G$ .

## Basic Performance Soft Starters

3RW50 soft starters > General data **NEW**

Type		3RW5055	3RW5056				
<b>Rated operational current <math>I_e</math></b>	A	143	171				
<b>Power electronics</b>							
<b>Load rating with rated operational current <math>I_e</math></b>							
IEC + UL/CSA, individual mounting at 40/50/60 °C, AC-53a	A	143/128/118	171/153/141				
<b>Permissible rated motor current and starts/h</b>							
<b>Normal starting (CLASS 10A)</b>							
Rated motor current $I_M$ , $T_U = 40/50/60$ °C	A	143/128/118	171/153/141				
ON period = 70%; motor protection activated							
• 300% $I_M$							
- Start-up time 5 s	1/h	43	43				
- Start-up time 10 s	1/h	18	18				
• 350% $I_M$							
- Start-up time 5 s	1/h	28	28				
- Start-up time 10 s	1/h	10	9				
<b>Normal starting (CLASS 10E)</b>							
Rated motor current $I_M$ , $T_U = 40/50/60$ °C	A	143/128/118	171/153/141				
ON period = 70%; motor protection activated							
• 300% $I_M$							
- Start-up time 20 s	1/h	21	21				
- Start-up time 40 s	1/h	8	8				
• 350% $I_M$							
- Start-up time 20 s	1/h	12	9				
- Start-up time 40 s	1/h	4	--				
<b>Heavy starting (CLASS 20E)</b>							
Rated motor current $I_M$ , $T_U = 40/50/60$ °C	A	108/98/88	135/123/111				
ON period = 70%; motor protection activated							
• 300% $I_M$							
- Start-up time 20 s	1/h	10	10				
- Start-up time 40 s	1/h	4	4				
• 350% $I_M$							
- Start-up time 20 s	1/h	7	7				
- Start-up time 40 s	1/h	2.5	2.5				
<b>Adjustable rated motor current <math>I_M</math></b>							
• Minimum/maximum	A	68/143	81/117				
<b>Type</b>							
		<b>3RW5072</b>	<b>3RW5073</b>	<b>3RW5074</b>	<b>3RW5075</b>	<b>3RW5076</b>	<b>3RW5077</b>
<b>Rated operational current <math>I_e</math></b>	A	210	250	315	370	470	570
<b>Power electronics</b>							
<b>Load rating with rated operational current <math>I_e</math></b>							
IEC + UL/CSA, individual mounting at 40/50/60 °C, AC-53a	A	210/186/170	250/220/200	315/279/255	370/328/300	470/416/380	570/504/460
<b>Permissible rated motor current and starts/h</b>							
<b>Normal starting (CLASS 10A)</b>							
Rated motor current $I_M$ , $T_U = 40/50/60$ °C	A	210/186/170	250/220/200	315/279/255	370/328/300	470/416/380	570/504/460
ON period = 70%; motor protection activated							
• 300% $I_M$							
- Start-up time 5 s	1/h	43	43	43	43	43	28
- Start-up time 10 s	1/h	18	18	18	18	18	11
• 350% $I_M$							
- Start-up time 5 s	1/h	28	28	28	28	28	16
- Start-up time 10 s	1/h	8	10	10	10	10	4
<b>Normal starting (CLASS 10E)</b>							
Rated motor current $I_M$ , $T_U = 40/50/60$ °C	A	210/186/170	250/220/200	315/279/255	370/328/300	470/416/380	570/504/460
ON period = 70%; motor protection activated							
• 300% $I_M$							
- Start-up time 20 s	1/h	21	21	21	21	20	21
- Start-up time 40 s	1/h	8	8	8	8	7	8
• 350% $I_M$							
- Start-up time 20 s	1/h	8	13	12	13	12	13
- Start-up time 40 s	1/h	--	4	4	4	2	4
<b>Heavy starting (CLASS 20E)</b>							
Rated motor current $I_M$ , $T_U = 40/50/60$ °C	A	162/146/130	200/180/160	219/195/171	258/230/202	272/254/218	284/262/240
ON period = 70%; motor protection activated							
• 300% $I_M$							
- Start-up time 20 s	1/h	10	10	10	10	10	10
- Start-up time 40 s	1/h	4	4	4	4	4	4
• 350% $I_M$							
- Start-up time 20 s	1/h	7	7	7	7	7	7
- Start-up time 40 s	1/h	2.5	2.5	2.5	2.5	2.5	2.5
<b>Adjustable rated motor current <math>I_M</math></b>							
• Minimum/maximum	A	90/210	100/250	135/315	160/370	200/470	240/570

# Basic Performance Soft Starters

3RW50 soft starters > General data **NEW**

### Motor feeders according to IEC with 3VA motor starter protectors/circuit breakers (without semiconductor protection)

Type of coordination "1", CLASS 10, short-circuit breaking capacity  $I_q$  in kA, see table

Note:

For general recommendations for constructing motor feeders with soft starters, see page 7/9.

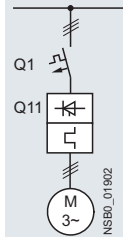

Soft starters	Motor starter protectors			
Q11	for 400 V systems		for 500 V systems	
Type	Q1	$I_q$ kA	Q1	$I_q$ kA
<b>Type of coordination "1"</b>	<b>Inline circuit</b>			
<b>3RW5055</b>	3VA2220-7MN32-0AA0	20	3VA2220-7MN32-0AA0	20
<b>3RW5056</b>	3VA2220-7MN32-0AA0	20	3VA2220-7MN32-0AA0	20
<b>3RW5072</b>	3VA2440-7MN32-0AA0	65	3VA2440-7MN32-0AA0	65
<b>3RW5073</b>	3VA2440-7MN32-0AA0	65	3VA2440-7MN32-0AA0	65
<b>3RW5074</b>	3VA2440-7MN32-0AA0	65	3VA2440-7MN32-0AA0	65
<b>3RW5075</b>	3VA2580-6HN32-0AA0	65	3VA2580-6HN32-0AA0	65
<b>3RW5076</b>	3VA2580-6HN32-0AA0	65	3VA2580-6HN32-0AA0	65
<b>3RW5077</b>	3VA2580-6HN32-0AA0	65	3VA2580-6HN32-0AA0	65

Note:

The service factor or measurement inaccuracies have been taken into account, for example, for the selection of the specified motor starter protectors/circuit breakers; the specified short-circuit breaking capacities  $I_q$  in kA are covered by combination tests. Smaller motor starter protectors/circuit breakers than those specified can be used at any time as smaller ones trip more quickly in the event of a short circuit (unchanged short-circuit breaking capacity) and thus protect the soft starter in any case. The dimensioning of the short-circuit components must, however, be suitable for the connected three-phase motor and the line protection for the cables used.

# Basic Performance Soft Starters

3RW50 soft starters > General data **NEW**

### Motor feeders according to IEC with 3NA3 fuses

gG class full-range fuses for cable and line protection according to IEC 60269-2, without semiconductor protection

Type of coordination "1",  
short-circuit breaking capacity  $I_{q} = 65 \text{ kA}$

Note:

For general recommendations for constructing motor feeders with soft starters, [see page 7/9](#).

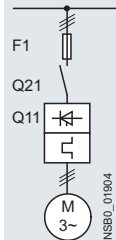

Soft starters	gG class fuse	Line contactor (optional)	
Q11	for systems up to 600 V	for systems up to 480 V	for systems up to 600 V
Type	F1	Q21	Q21
Type	Type	Type	Type
<b>Type of coordination "1"</b>	<b>Inline circuit</b>		
<b>3RW5055</b>	3NA3244-6	3RT1055	3RT1055
<b>3RW5056</b>	3NA3244-6	3RT1056	3RT1064
<b>3RW5072</b>	2 x 3NA3354-6	3RT1064	3RT1064
<b>3RW5073</b>	2 x 3NA3354-6	3RT1065	3RT1065
<b>3RW5074</b>	2 x 3NA3365-6	3RT1075	3RT1075
<b>3RW5075</b>	2 x 3NA3365-6	3RT1075	3RT1075
<b>3RW5076</b>	2 x 3NA3365-6	3RT1076	3RT1076
<b>3RW5077</b>	2 x 3NA3365-6	3TF68	3TF68

Note:

The specified short-circuit breaking capacities  $I_{q}$  in kA are covered by combination tests. Smaller fuses than those specified can be used at any time as smaller ones trip more quickly in the event of a short circuit (unchanged short-circuit breaking capacity) and thus protect the soft starter in any case. The dimensioning of the short-circuit components must, however, be suitable for the connected three-phase motor and the line protection for the cables used.

# Basic Performance Soft Starters

3RW50 soft starters > General data **NEW**

### Motor feeders according to IEC with 3NE1 SITOP fuses

gR class full-range fuses for semiconductor protection, cable and line protection

Type of coordination "2",  
short-circuit breaking capacity  $I_{q} = 65 \text{ kA}$

Note:

For general recommendations for constructing motor feeders with soft starters, [see page 7/9](#).

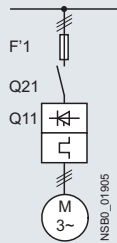

Soft starters	gG class fuse	Line contactor (optional)	
Q11	for systems up to 600 V	for systems up to 480 V	for systems up to 600 V
Type	F'1	Q21	Q21
Type	Type	Type	Type
Type of coordination "2"	Inline circuit		
<b>3RW5055</b>	3NE1227-0	3RT1055	3RT1055
<b>3RW5056</b>	3NE1230-0	3RT1056	3RT1064
<b>3RW5072</b>	3NE1230-2	3RT1064	3RT1064
<b>3RW5073</b>	3NE1331-0	3RT1065	3RT1065
<b>3RW5074</b>	3NE1333-2	3RT1075	3RT1075
<b>3RW5075</b>	3NE1334-2	3RT1075	3RT1075
<b>3RW5076</b>	3NE1436-2	3RT1076	3RT1076
<b>3RW5077</b>	3NE1437-2	3TF68	3TF68

Note:

The specified short-circuit breaking capacities  $I_{q}$  in kA are covered by combination tests. Smaller fuses than those specified can be used at any time as smaller ones trip more quickly in the event of a short circuit (unchanged short-circuit breaking capacity) and thus protect the soft starter in any case. The dimensioning of the short-circuit components must, however, be suitable for the connected three-phase motor and the line protection for the cables used.

# Basic Performance Soft Starters

3RW50 soft starters > General data **NEW**

### Motor feeders according to IEC with 3NE3 fuses

aR class partial-range fuses for semiconductor protection

Type of coordination "2",

short-circuit breaking capacity  $I_{q} = 65 \text{ kA}$

Note:

For general recommendations for constructing motor feeders with soft starters, see page 7/9.

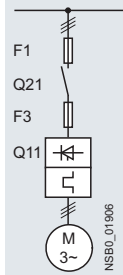

Soft starters	gG class fuse	aR class fuse	Line contactor (optional)	
Q11	for systems up to 600 V	for systems up to 600 V	for systems up to 480 V	for systems up to 600 V
Type	F1	F3	Q21	Q21
Type	Type	Type	Type	Type
Type of coordination "2"	Inline circuit			
<b>3RW5055</b>	3NA3244-6	3NE3334-0B	3RT1055	3RT1055
<b>3RW5056</b>	3NA3244-6	3NE3335	3RT1056	3RT1064
<b>3RW5072</b>	2 x 3NA3354-6	3NE3333	3RT1064	3RT1064
<b>3RW5073</b>	2 x 3NA3354-6	3NE3335	3RT1065	3RT1065
<b>3RW5074</b>	2 x 3NA3365-6	3NE3335	3RT1075	3RT1075
<b>3RW5075</b>	2 x 3NA3365-6	3NE3336	3RT1075	3RT1075
<b>3RW5076</b>	2 x 3NA3365-6	3NE3340-8	3RT1076	3RT1076
<b>3RW5077</b>	2 x 3NA3365-6	3NE3340-8	3TF68	3TF68

Note:

The specified short-circuit breaking capacities  $I_{q}$  in kA are covered by combination tests. Smaller fuses than those specified can be used at any time as smaller ones trip more quickly in the event of a short circuit (unchanged short-circuit breaking capacity) and thus protect the soft starter in any case. The dimensioning of the short-circuit components must, however, be suitable for the connected three-phase motor and the line protection for the cables used.

For CLASS 10 applications, as an alternative to the gG class full-range fuses for cable and line protection 3NA3 (F1), 3VA circuit breakers can also be used, possibly with reduced short-circuit breaking capacity (see page 7/76). In these cases optional line contactors can be dispensed with.

# Basic Performance Soft Starters

3RW50 soft starters > Inline circuit **IE3/IE4 ready** **NEW**

## Selection and ordering data

For normal starting (CLASS 10E)



3RW5055



3RW5075

At 40 °C				At 50 °C				Size	SD <sup>1)</sup>	Article No.	Price per PU	PU (UNIT, SET, M)	PS*
Operational current	Operating power for three-phase motors			Operational current	Rating [hp] for three-phase motors								
	At 230 V	At 400 V	At 500 V		At 200/208 V	At 220/230 V	At 460/480 V	At 575/600 V					
A	kW	kW	kW	A	hp	hp	hp	hp	d				
<b>Operational voltage 200 ... 480 V</b>													
143	37	75	90	128	30	30	100	--	S6	5	3RW5055-□□B□4	1	1 unit
171	45	90	110	153	30	40	100	--	S6	5	3RW5056-□□B□4	1	1 unit
210	55	110	132	186	40	50	150	--	S12	5	3RW5072-□□B□4	1	1 unit
250	75	132	160	220	50	60	150	--	S12	5	3RW5073-□□B□4	1	1 unit
315	90	160	200	279	60	75	200	--	S12	5	3RW5074-□□B□4	1	1 unit
370	110	200	250	328	75	100	250	--	S12	5	3RW5075-□□B□4	1	1 unit
470	132	250	315	416	100	125	350	--	S12	5	3RW5076-□□B□4	1	1 unit
570	160	315	355	504	125	150	400	--	S12	5	3RW5077-□□B□4	1	1 unit

**Type of electrical connection for the control circuit**

Spring-loaded terminals  
Screw terminals

**Product function**

Analog output  
Thermistor motor protection

**Control supply voltage**

24 V AC/DC  
110 ... 250 V AC



<sup>1)</sup> 3RW50 soft starter with screw terminals for operational voltage up to 480 V. Standard delivery time SD = 1 day (d).

Note: For the constraints for the motor outputs specified here, see page 7/7.

SOFT STARTERS 7

At 40 °C				At 50 °C				Size	SD <sup>1)</sup>	Article No.	Price per PU	PU (UNIT, SET, M)	PS*
Operational current	Operating power for three-phase motors			Operational current	Rating [hp] for three-phase motors								
	At 230 V	At 400 V	At 500 V		At 200/208 V	At 220/230 V	At 460/480 V	At 575/600 V					
A	kW	kW	kW	A	hp	hp	hp	hp	d				
<b>Operational voltage 200 ... 600 V</b>													
143	37	75	90	128	30	30	100	75	S6	5	3RW5055-□□B□5	1	1 unit
171	45	90	110	153	30	40	100	100	S6	5	3RW5056-□□B□5	1	1 unit
210	55	110	132	186	40	50	150	125	S12	5	3RW5072-□□B□5	1	1 unit
250	75	132	160	220	50	60	150	150	S12	5	3RW5073-□□B□5	1	1 unit
315	90	160	200	279	60	75	200	200	S12	5	3RW5074-□□B□5	1	1 unit
370	110	200	250	328	75	100	250	250	S12	5	3RW5075-□□B□5	1	1 unit
470	132	250	315	416	100	125	350	300	S12	5	3RW5076-□□B□5	1	1 unit
570	160	315	355	504	125	150	400	400	S12	5	3RW5077-□□B□5	1	1 unit

**Type of electrical connection for the control circuit**

Spring-loaded terminals  
Screw terminals

**Product function**

Analog output  
Thermistor motor protection

**Control supply voltage**

24 V AC/DC  
110 ... 250 V AC



<sup>1)</sup> 3RW50 soft starter with screw terminals for operational voltage up to 600 V. Standard delivery time SD = 2 days (d).







Note: For the constraints for the motor outputs specified here, see page 7/7.



# Basic Performance Soft Starters

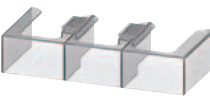



## 3RW50 soft starters > Accessories

### Selection and ordering data

Product designation	Manufacturer's Article No. of the soft starter	Type of product	Application	SD	Article No.	Price per PU	PU (UNIT, SET, M)	PS*	PG	
<b>Fan covers</b>										
	<b>Fan cover</b>	3RW50 (1x)	--	--	▶	<b>3RW5985-0FC00</b>		1	1 unit	42S
3RW5985-0FC00										
<b>Box terminal block</b>										
	<b>Box terminal block for round and ribbon cables</b>	3RW505 (2x)	Up to 70 mm <sup>2</sup>	--	▶	<b>3RT1955-4G</b>		1	1 unit	41B
		3RW507 (2x)	Up to 120 mm <sup>2</sup>	--	▶	<b>3RT1956-4G</b>		1	1 unit	41B
3RT1956-4G										
<b>Terminal covers</b>										
	<b>Covers for box terminals</b>	3RW505 (2x)	--	--	▶	<b>3RT1956-4EA2</b>		1	1 unit	41B
		3RW507 (2x)	--	--	▶	<b>3RT1966-4EA2</b>		1	1 unit	41B
3RT1956-4EA2										
	<b>Covers for cable lugs and busbar connections</b>	3RW505 (2x)	--	--	▶	<b>3RT1956-4EA1</b>		1	1 unit	41B
		3RW507 (2x)	--	--	▶	<b>3RT1966-4EA1</b>		1	1 unit	41B
3RT1956-4EA1										
<b>Communication modules</b>										
	<b>Communication module</b>	3RW50	PROFINET Standard	--	▶	<b>3RW5980-0CS00</b>		1	1 unit	42S
			PROFIBUS		▶	<b>3RW5980-0CP00</b>		1	1 unit	42S
			EtherNet/IP		▶	<b>3RW5980-0CE00</b>		1	1 unit	42S
			Modbus RTU		▶	<b>3RW5980-0CR00</b>		1	1 unit	42S
			Modbus TCP		▶	<b>3RW5980-0CT00</b>		1	1 unit	42S
3RW5980-0CS00										
	<b>COM connection cable</b>	3RW50	0.3 m	--	▶	<b>3RW5900-0CC00</b>		1	1 unit	42S
3RW5900-0CC00										
For mounting laterally on the device										

# Basic Performance Soft Starters

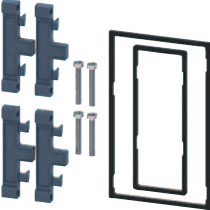
## 3RW50 soft starters > Accessories

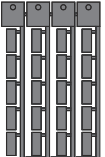
Product designation	Manufacturer's Article No. of the soft starter	Type of product	Application	SD	Article No.	Price per PU	PU (UNIT, SET, M)	PS*	PG	
<b>HMI modules</b>										
	<b>HMI module</b>	3RW50	High Feature	--	▶	<b>3RW5980-0HF00</b>		1	1 unit	42S
3RW5980-0HF00										
			Standard	--	▶	<b>3RW5980-0HS00</b>		1	1 unit	42S
3RW5980-0HS00										
	<b>IP65 door mounting kit for HMI modules</b>	3RW50	IP65	For HMI modules	▶	<b>3RW5980-0HD00</b>		1	1 unit	42S
3RW5980-0HD00										
<b>Connecting cables</b>										
	<b>HMI connection cable</b>	3RW50	5 m, round	For door mounting	▶	<b>3RW5980-0HC60</b>		1	1 unit	42S
			2.5 m, round		▶	<b>3UF7933-0BA00-0</b>		1	1 unit	42J
			1.0 m, round		▶	<b>3UF7937-0BA00-0</b>		1	1 unit	42J
			0.5 m, round		▶	<b>3UF7932-0BA00-0</b>		1	1 unit	42J
3UF793-0BA00-0										
<b>Further accessories</b>										
	<b>Push-in lugs for wall mounting</b>	--	Two lugs are required per device	For HMI modules and communication modules	2	<b>3ZY1311-0AA00</b>		1	10 units	41L
3ZY1311-0AA00										
<b>Blank labels</b>										
	<b>Unit labeling plates<sup>1)</sup></b>	--	20 mm x 7 mm, titanium gray	For SIRIUS devices	20	<b>3RT2900-1SB20</b>		100	340 units	41B
3RT2900-1SB20										

<sup>1)</sup> PC labeling systems for individual inscription of unit labeling plates are available from: murrplastik Systemtechnik GmbH (see page 16/15).

# Basic Performance Soft Starters

## 3RW40 soft starters > General data

### Overview

#### More information

Homepage, see [www.usa.siemens.com/soft-starter](http://www.usa.siemens.com/soft-starter)  
 Industry Mall, see [www.siemens.com/product?3RW40](http://www.siemens.com/product?3RW40)

TIA Selection Tool Cloud (TST Cloud), see <https://www.siemens.com/tstcloud/?node=3rw40>  
 Simulation Tool for Soft Starters (STS), see page 7/7 or <https://support.industry.siemens.com/cs/ww/en/view/101494917>



The SIRIUS 3RW40 Basic Performance soft starters are suitable for soft starting and stopping of three-phase asynchronous motors.

Thanks to two-phase control, not only is the current kept at minimum values in all three phases throughout the entire starting time, but disturbing direct current components are also eliminated. This not only enables the two-phase starting of motors from 7.5 to 75HP @ 480V but also avoids the current and torque peaks which occur e.g. with wye-delta starters.

The SIRIUS 3RW40 soft starters are suitable for the starting of explosion-proof motors with "increased safety" type of protection EEx e according to ATEX Directive 94/9/EC.

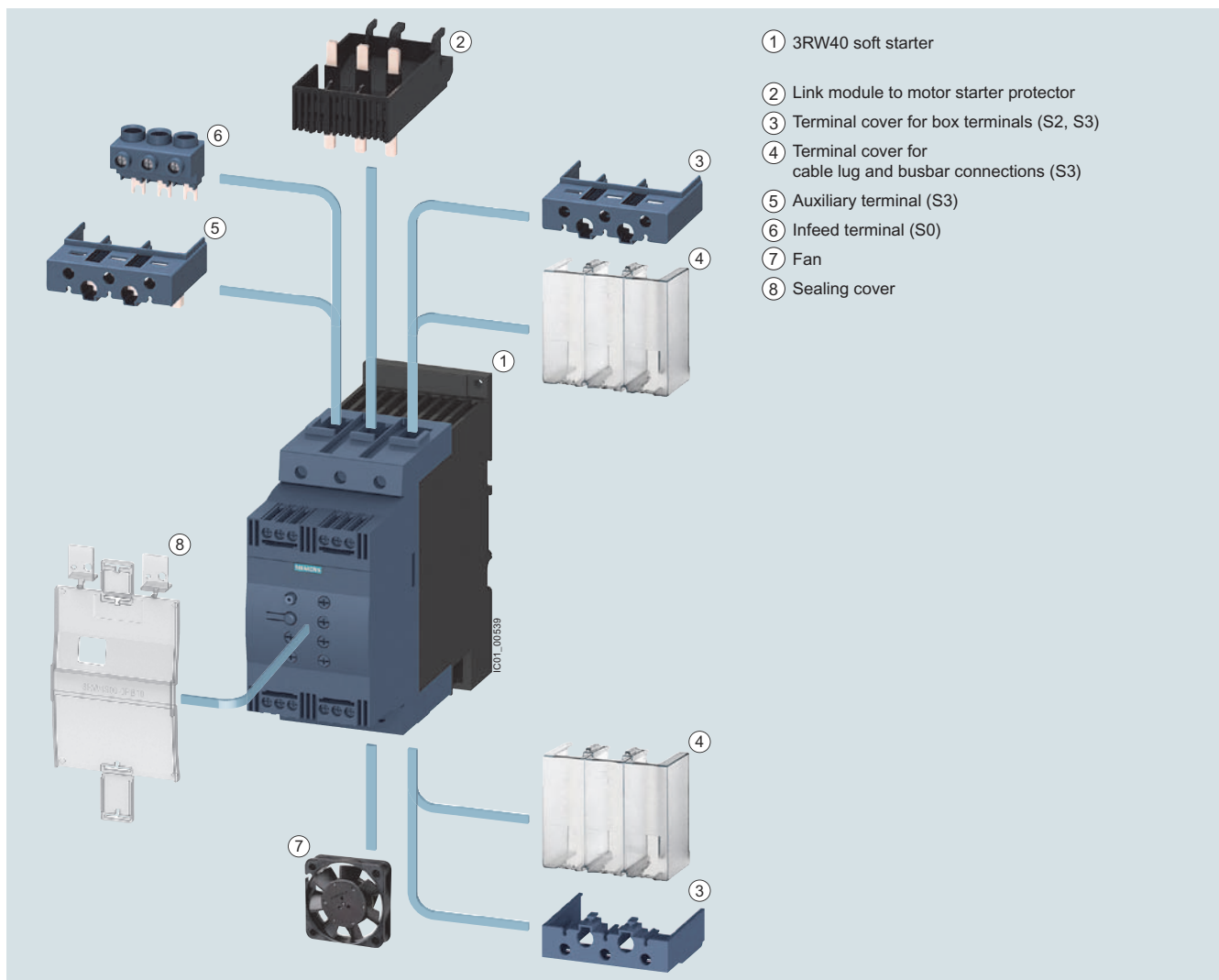

3RW40 Basic Performance soft starters with accessories (see page 7/92)

# Basic Performance Soft Starters

## 3RW40 soft starters > General data

### Benefits



Product characteristics / function	Performance features / benefits
Small and compact design	Space-saving, clearly arranged control panel layout
Motor overload and intrinsic device protection without additional wiring	Adjustable trip classes, integrated diagnostics functions
Integrated in the SIRIUS modular system	Link modules to motor starter protectors
Hybrid switching devices and two-phase motor control	Minimum power loss and optimized motor control by avoiding DC components
Certified according to ATEX Directive 94/9/EC	Suitable for the starting of explosion-proof motors with "increased safety" type of protection EEx e.
Optional thermistor motor protection	Full motor protection

## Technical specifications

### More information

Technical specifications, see <https://support.industry.siemens.com/cs/ww/en/ps/25252/tid>  
 Equipment Manual "SIRIUS 3RW30/3RW40 Soft Starter", see <https://support.industry.siemens.com/cs/ww/en/view/38752095>

FAQs, see <https://support.industry.siemens.com/cs/ww/en/ps/25251/faq>  
 Simulation Tool for Soft Starters (STS), see page 7/7 or <https://support.industry.siemens.com/cs/ww/en/view/101494917>

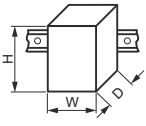
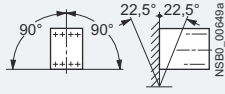
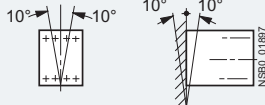
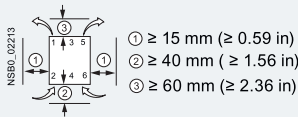
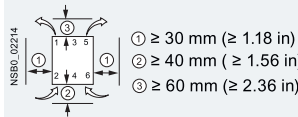
Type		3RW402.	3RW403.	3RW404.	
<b>Mechanics and environment</b>					
<b>Mounting dimensions (W x H x D)</b> • Screw terminals • Spring-loaded terminals		mm	45 x 125 x 154	55 x 144 x 170	70 x 160 x 188
		mm	45 x 150 x 154	55 x 144 x 170	70 x 160 x 188
<b>Permissible ambient temperature</b>					
During operation		°C	-25 ... +60; (derating from +40)		
During storage		°C	-40 ... +80		
<b>Weight</b>		kg	0.77	1.35	1.9
<b>Permissible mounting position<sup>1)</sup></b>					
• With auxiliary fan (for 3RW402. ... 3RW404.)					
• Without auxiliary fan (for 3RW402. ... 3RW404.)					
<b>Installation type<sup>1)</sup></b>					
	Stand-alone installation				
		① ≥ 15 mm (≥ 0.59 in)		① ≥ 30 mm (≥ 1.18 in)	
		② ≥ 40 mm (≥ 1.56 in)		② ≥ 40 mm (≥ 1.56 in)	
		③ ≥ 60 mm (≥ 2.36 in)		③ ≥ 60 mm (≥ 2.36 in)	
<b>Permissible installation altitude</b>		m	5 000 (Derating from 1 000, see characteristic curve on page 7/7)		
<b>Degree of protection</b>		IP00			

<sup>1)</sup> In the case of deviations, please observe derating, see Equipment Manual in the chapter "Configuring".

Type	Terminal	3RW402., 3RW403., 3RW404.		
<b>Control electronics</b>				
<b>Rated values</b>				
Rated control supply voltage	A1/A2	V	24 AC/DC ± 20	110 ... 230 AC/DC -15/+10
Rated frequency		Hz	50/60	
• Tolerance		%	± 10	

Type		3RW402...B.4, 3RW403...B.4, 3RW404...B.4	3RW402...B.5, 3RW403...B.5, 3RW404...B.5
<b>Power electronics</b>			
<b>Rated operational voltage</b>	V AC	200 ... 480	400 ... 600
Tolerance	%	-15/+10	
<b>Maximum blocking voltage (thyristor)</b>	V AC	1 600	
<b>Rated frequency</b>	Hz	50/60	
Tolerance	%	± 10	
<b>Uninterrupted duty at 40 °C (% of I<sub>θ</sub>)</b>	%	115	
<b>Minimum load (% of smallest adjustable rated motor current I<sub>M</sub>)</b>	%	20 (at least 2 A)	
<b>Maximum cable length</b> between soft starter and motor	m	300	

# Basic Performance Soft Starters

## 3RW40 soft starters > General data

Type		3RW4024	3RW4026	3RW4027	3RW4028
<b>Power electronics</b>					
<b>Load rating with rated operational current <math>I_e</math></b>					
• According to IEC and UL/CSA <sup>1)</sup> , individual mounting at 40/50/60 °C, AC-53a	A	12.5/11/10	25.3/23/21	32.2/29/26	38/34/31
<b>Smallest adjustable rated motor current <math>I_M</math></b>					
For the motor overload protection	A	5	10	17	23
<b>Power loss</b>					
• In operation after completed starting with uninterrupted rated operational current (40 °C) approx.	W	2	8	13	19
• During starting with current limiting set to 300% $I_M$ (40 °C)	W	68	188	220	256
<b>Permissible rated motor current and starts per hour</b>					
• For normal starting (CLASS 10) at 40/50 °C					
- Rated motor current $I_M^{(2)}$ , start-up time 3 s	A	12.5/11	25/23	32/29	38/34
- Starts per hour <sup>3)</sup>	1/h	50/50	23/23	23/23	19/19
- Rated motor current $I_M^{(2)}$ , start-up time 4 s	A	12.5/11	25/23	32/29	38/34
- Starts per hour <sup>3)</sup>	1/h	36/36	15/15	16/16	12/12
• For heavy starting (CLASS 20) at 40/50 °C					
- Rated motor current $I_M^{(2)}$ , start-up time 6 s	A	10/9	21/19	27/24	31/28
- Starts per hour <sup>3)</sup>	1/h	47/47	21/21	20/20	18/18
- Rated motor current $I_M^{(2)}$ , start-up time 8 s	A	10/9	21/19	27/24	31/28
- Starts per hour <sup>3)</sup>	1/h	34/34	15/15	14/14	13/13

<sup>1)</sup> Measurement at 60 °C according to UL/CSA not required.

<sup>2)</sup> Current limiting on soft starter set to 300%  $I_M$ ,  $T_u = 40/50$  °C. Maximum adjustable rated motor current  $I_M$  dependent on CLASS setting.

<sup>3)</sup> For intermittent duty S4 with ON period = 30%,  $T_u = 40/50$  °C, stand-alone installation vertical. The quoted switching frequencies do not apply for automatic mode. Factors for permissible switching frequency in other mounting position, direct mounting, side-by-side mounting, and implementation of optional auxiliary fan, see Equipment Manual in the chapter "Configuring".

Type		3RW4036	3RW4037	3RW4038	3RW4046	3RW4047
<b>Power electronics</b>						
<b>Load rating with rated operational current <math>I_e</math></b>						
• According to IEC and UL/CSA <sup>1)</sup> , individual mounting at 40/50/60 °C, AC-53a	A	45/42/39	63/58/53	72/62.1/60	80/73/66	106/98/90
<b>Smallest adjustable rated motor current <math>I_M</math></b>						
For the motor overload protection	A	23	26	35	43	46
<b>Power loss</b>						
• In operation after completed starting with uninterrupted rated operational current (40 °C) approx.	W	6	12	15	12	21
• During starting with current limiting set to 300% $I_M$ (40 °C)	W	316	444	500	576	768
<b>Permissible rated motor current and starts per hour</b>						
• For normal starting (CLASS 10) at 40/50 °C						
- Rated motor current $I_M^{(2)}$ , start-up time 3 s	A	45/42	63/58	72/62	80/73	106/98
- Starts per hour <sup>3)</sup>	1/h	38/38	23/23	22/22	22/22	15/15
- Rated motor current $I_M^{(2)}$ , start-up time 4 s	A	45/42	63/58	72/62	80/73	106/98
- Starts per hour <sup>3)</sup>	1/h	26/26	15/15	15/15	15/15	10/10
• For heavy starting (CLASS 20) at 40/50 °C						
- Rated motor current $I_M^{(2)}$ , start-up time 6 s	A	38/34	46/42	50/46	64/58	77/70
- Starts per hour <sup>3)</sup>	1/h	30/30	31/31	34/34	23/23	23/23
- Rated motor current $I_M^{(2)}$ , start-up time 8 s	A	38/34	46/42	50/46	64/58	77/70
- Starts per hour <sup>3)</sup>	1/h	21/21	22/22	24/24	16/16	16/16

<sup>1)</sup> Measurement at 60 °C according to UL/CSA not required.

<sup>2)</sup> Current limiting on soft starter set to 300%  $I_M$ ,  $T_u = 40/50$  °C. Maximum adjustable rated motor current  $I_M$  dependent on CLASS setting.

<sup>3)</sup> For intermittent duty S4 with ON period = 30%,  $T_u = 40/50$  °C, stand-alone installation vertical. The quoted switching frequencies do not apply for automatic mode. Factors for permissible switching frequency in other mounting position, direct mounting, side-by-side mounting, and implementation of optional auxiliary fan, see Equipment Manual in the chapter "Configuring".

# Basic Performance Soft Starters

## 3RW40 soft starters > General data

### Motor feeders according to IEC with 3RV2 motor starter protectors (without semiconductor protection)

Type of coordination "1", CLASS 10, short-circuit breaking capacity  $I_q$  in kA, see table

Note:

For general recommendations for constructing motor feeders with soft starters, see page 7/9.

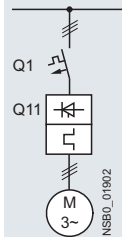

Soft starters	Motor starter protectors			
Q11	for 400 V systems		for 500 V systems	
Type	Type	$I_q$ kA	Type	$I_q$ kA
<b>Type of coordination "1"</b>	<b>Inline circuit</b>			
<b>3RW4024</b>	3RV2021-4AA10	55	3RV2021-4AA10	10
<b>3RW4026</b>	3RV2021-4DA10	55	3RV2021-4DA10	10
<b>3RW4027</b>	3RV2021-4EA10	55	3RV2021-4EA10	10
<b>3RW4028</b>	3RV2021-4FA10	55	3RV2021-4FA10	10
<b>3RW4036</b>	3RV2031-4WA10	10	3RV2031-4WA10	10
<b>3RW4037</b>	3RV2031-4JA10	10	3RV2031-4JA10	5
<b>3RW4038</b>	3RV2031-4KA10	10	3RV2031-4KA10	5
<b>3RW4046</b>	3RV2041-4RA10	11	3RV2041-4YA10	5
<b>3RW4047</b>	3RV2041-4MA10	11	3RV2041-4MA10	5

Note:

The specified short-circuit breaking capacities  $I_q$  in kA are covered by combination tests. Smaller motor starter protectors/circuit breakers than those specified can be used at any time as smaller ones trip more quickly in the event of a short circuit (unchanged short-circuit breaking capacity) and thus protect the soft starter in any case. The dimensioning of the short-circuit components must, however, be suitable for the connected three-phase motor and the line protection for the cables used.

# Basic Performance Soft Starters

## 3RW40 soft starters > General data

### Motor feeders according to IEC with 3NE1 SITOR fuses

gR class full-range fuses for semiconductor protection, cable and line protection

Type of coordination "2",  
short-circuit breaking capacity  $I_q = 65 \text{ kA}$

Note:

For general recommendations for constructing motor feeders with soft starters, [see page 7/9](#).

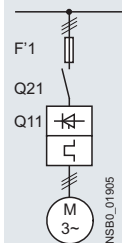

Soft starters	gG class fuse for systems up to 600 V	Line contactor (optional)		
		for systems up to 400 V	for systems up to 480 V	for systems up to 600 V
Q11 Type	F'1 Type	Q21 Type	Q21 Type	Q21 Type
<b>Type of coordination "2"</b>	<b>Inline circuit</b>			
<b>3RW4024</b>	3NE1814-0	3RT2025	3RT2025/ 3RT2018 (in size S00)	3RT2025
<b>3RW4026</b>	3NE1803-0	3RT2026	3RT2027	3RT2037
<b>3RW4027</b>	3NE1020-2	3RT2027	3RT2028	3RT2037
<b>3RW4028</b>	3NE1020-2	3RT2028	3RT2035	3RT2037
<b>3RW4036</b>	3NE1020-2	3RT2036	3RT2036	3RT2038
<b>3RW4037</b>	3NE1820-0	3RT2037	3RT2037	3RT2046
<b>3RW4038</b>	3NE1820-0	3RT2038	3RT2038	3RT2046
<b>3RW4046</b>	3NE1021-0	3RT2045	3RT2045	3RT2047
<b>3RW4047</b>	3NE1022-0	3RT2047	3RT2047	3RT1054

Note:

The specified short-circuit breaking capacities  $I_q$  in kA are covered by combination tests. Smaller fuses than those specified can be used at any time as smaller ones trip more quickly in the event of a short circuit (unchanged short-circuit breaking capacity) and thus protect the soft starter in any case. The dimensioning of the short-circuit components must, however, be suitable for the connected three-phase motor and the line protection for the cables used.



# Basic Performance Soft Starters

## 3RW40 soft starters > General data

### Motor feeders according to IEC with 3NE8 / 3NE4 / 3NE3 / 3NC fuses

aR class partial-range fuses for semiconductor protection

Type of coordination "2",  
short-circuit breaking capacity  $I_q = 65 \text{ kA}$

Note:

For general recommendations for constructing motor feeders with soft starters, [see page 7/9](#).

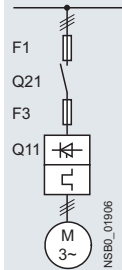

Soft starters	gG class fuse	aR class fuse			Cylindrical fuses	Line contactor (optional)		
	for systems up to 600 V	for systems up to 600 V	for systems up to 600 V	for systems up to 600 V	for systems up to 480 V	for systems up to 400 V	for systems up to 480 V	for systems up to 600 V
Q11	F1	F3	F3	F3	F3	Q21	Q21	Q21
Type	Type	Type	Type	Type	Type	Type	Type	Type
<b>Type of coordination "2"</b>	<b>Inline circuit</b>							
	<b>Toc 2</b>							
<b>3RW4024</b>	3NA3820-6	--	3NE4101	3NE8015-1	3NC2240	3RT2025	3RT2025/ 3RT2018 (in size S00)	3RT2025
<b>3RW4026</b>	3NA3822-6	--	3NE4102	3NE8017-1	3NC2263	3RT2026	3RT2027	3RT2037
<b>3RW4027</b>	3NA3824-6	--	3NE4118	3NE8018-1	3NC2280	3RT2027	3RT2028	3RT2037
<b>3RW4028</b>	3NA3824-6	--	3NE4118	3NE8020-1	3NC2280	3RT2028	3RT2035	3RT2037
<b>3RW4036</b>	3NA3130-6	--	3NE4120	3NE8020-1	3NC2280	3RT2036	3RT2036	3RT2038
<b>3RW4037</b>	3NA3132-6	--	3NE4121	3NE8021-1	--	3RT2037	3RT2037	3RT2046
<b>3RW4038</b>	3NA3132-6	3NE3221	--	3NE8022-1	--	3RT2038	3RT2038	3RT2046
<b>3RW4046</b>	3NA3136-6	3NE3222	--	3NE8022-1	--	3RT2045	3RT2045	3RT2047
<b>3RW4047</b>	3NA3136-6	3NE3224	--	3NE8024-1	--	3RT2047	3RT2047	3RT1054

Note:

The specified short-circuit breaking capacities  $I_q$  in kA are covered by combination tests. Smaller fuses than those specified can be used at any time as smaller ones trip more quickly in the event of a short circuit (unchanged short-circuit breaking capacity) and thus protect the soft starter in any case. The dimensioning of the short-circuit components must, however, be suitable for the connected three-phase motor and the line protection for the cables used.

For CLASS 10 applications, as an alternative to the gG class full-range fuses for cable and line protection 3NA3 (F1), 3RV2 motor starter protectors can also be used, possibly with reduced short-circuit breaking capacity ([see page 7/87](#)). In these cases, optional line contactors can be dispensed with.

# Basic Performance Soft Starters

3RW40 soft starters > Inline circuit **IE3/IE4 ready**

## Selection and ordering data

For normal starting (CLASS 10)



3RW402.



3RW403.



3RW404.

3RW ambient temperature 40 °C				3RW ambient temperature 50 °C				Size	SD <sup>1)</sup>	Article No.	Price per PU	PU (UNIT, SET, M)	PS*
Rated values of three-phase motors				Rated values of three-phase motors									
Operational current $I_e$	Rating at operational voltage $U_e$			Operational current $I_e$	Rating at operational voltage $U_e$			d					
	230 V	400 V	500 V		200 V	230 V	460 V						575 V
A	kW	kW	kW	A	hp	hp	hp	hp					
<b>Rated operational voltage <math>U_e</math> 200 ... 480 V</b>													
12.5	3	<b>5.5</b>	--	11	3	3	<b>7.5</b>	--	S0	2	3RW4024-□BB□4	1	1 unit
25	5.5	<b>11</b>	--	23	5	5	<b>15</b>	--	S0	2	3RW4026-□BB□4	1	1 unit
32	7.5	<b>15</b>	--	29	7.5	7.5	<b>20</b>	--	S0	2	3RW4027-□BB□4	1	1 unit
38	11	<b>18.5</b>	--	34	10	10	<b>25</b>	--	S0	2	3RW4028-□BB□4	1	1 unit
45	11	<b>22</b>	--	42	10	15	<b>30</b>	--	S2	2	3RW4036-□BB□4	1	1 unit
63	18.5	<b>30</b>	--	58	15	20	<b>40</b>	--	S2	2	3RW4037-□BB□4	1	1 unit
72	22	<b>37</b>	--	62	20	20	<b>40</b>	--	S2	2	3RW4038-□BB□4	1	1 unit
80	22	<b>45</b>	--	73	20	25	<b>50</b>	--	S3	2	3RW4046-□BB□4	1	1 unit
106	30	<b>55</b>	--	98	30	30	<b>75</b>	--	S3	2	3RW4047-□BB□4	1	1 unit
<b>Rated operational voltage <math>U_e</math> 400 ... 600 V</b>													
12.5	--	5.5	<b>7.5</b>	11	--	--	7.5	<b>10</b>	S0	5	3RW4024-□BB□5	1	1 unit
25	--	11	<b>15</b>	23	--	--	15	<b>20</b>	S0	5	3RW4026-□BB□5	1	1 unit
32	--	15	<b>18.5</b>	29	--	--	20	<b>25</b>	S0	5	3RW4027-□BB□5	1	1 unit
38	--	18.5	<b>22</b>	34	--	--	25	<b>30</b>	S0	5	3RW4028-□BB□5	1	1 unit
45	--	22	<b>30</b>	42	--	--	30	<b>40</b>	S2	5	3RW4036-□BB□5	1	1 unit
63	--	30	<b>37</b>	58	--	--	40	<b>50</b>	S2	5	3RW4037-□BB□5	1	1 unit
72	--	37	<b>45</b>	62	--	--	40	<b>60</b>	S2	5	3RW4038-□BB□5	1	1 unit
80	--	45	<b>55</b>	73	--	--	50	<b>60</b>	S3	5	3RW4046-□BB□5	1	1 unit
106	--	55	<b>75</b>	98	--	--	75	<b>75</b>	S3	5	3RW4047-□BB□5	1	1 unit

### Article No. supplement for connection types

- Screw terminals
- Spring-loaded terminals<sup>2)</sup>

### Control supply voltage

- 24 V AC/DC
- 110 ... 230 V AC/DC

<sup>1)</sup> Soft starter  $U_e$  200 to 480 V with screw terminals: Standard delivery time SD = 1 day (d).

<sup>2)</sup> Main connection from size S2: screw terminals.

### Note:

For the constraints for the motor outputs specified here, see page 7/7.



# Basic Performance Soft Starters

3RW40 soft starters > Inline circuit **IE3/IE4 ready**

**For normal starting (CLASS 10)**



3RW402.



3RW403.



3RW404.

3RW ambient temperature 40 °C				3RW ambient temperature 50 °C				Size	SD <sup>1)</sup>	Article No.	Price per PU	PU (UNIT, SET, M)	PS*
Rated values of three-phase motors				Rated values of three-phase motors									
Operational current $I_e$	Rating at operational voltage $U_e$			Operational current $I_e$	Rating at operational voltage $U_e$			d					
	230 V	400 V	500 V		200 V	230 V	460 V						575 V
A	kW	kW	kW	A	hp	hp	hp	hp					
<b>Rated operational voltage <math>U_e</math> 200 ... 480 V, with thermistor motor protection, rated control supply voltage <math>U_s</math> 24 V AC/DC</b>													
12.5	3	<b>5.5</b>	--	11	3	3	<b>7.5</b>	--	<b>S0</b>	5	<b>3RW4024-□TB04</b>	1	1 unit
25	5.5	<b>11</b>	--	23	5	5	<b>15</b>	--	<b>S0</b>	5	<b>3RW4026-□TB04</b>	1	1 unit
32	7.5	<b>15</b>	--	29	7.5	7.5	<b>20</b>	--	<b>S0</b>	5	<b>3RW4027-□TB04</b>	1	1 unit
38	11	<b>18.5</b>	--	34	10	10	<b>25</b>	--	<b>S0</b>	5	<b>3RW4028-□TB04</b>	1	1 unit
45	11	<b>22</b>	--	42	10	15	<b>30</b>	--	<b>S2</b>	5	<b>3RW4036-□TB04</b>	1	1 unit
63	18.5	<b>30</b>	--	58	15	20	<b>40</b>	--	<b>S2</b>	5	<b>3RW4037-□TB04</b>	1	1 unit
72	22	<b>37</b>	--	62	20	20	<b>40</b>	--	<b>S2</b>	5	<b>3RW4038-□TB04</b>	1	1 unit
80	22	<b>45</b>	--	73	20	25	<b>50</b>	--	<b>S3</b>	5	<b>3RW4046-□TB04</b>	1	1 unit
106	30	<b>55</b>	--	98	30	30	<b>75</b>	--	<b>S3</b>	5	<b>3RW4047-□TB04</b>	1	1 unit
<b>Rated operational voltage <math>U_e</math> 400 ... 600 V, with thermistor motor protection, rated control supply voltage <math>U_s</math> 24 V AC/DC</b>													
12.5	--	5.5	<b>7.5</b>	11	--	--	7.5	<b>10</b>	<b>S0</b>	5	<b>3RW4024-□TB05</b>	1	1 unit
25	--	11	<b>15</b>	23	--	--	15	<b>20</b>	<b>S0</b>	5	<b>3RW4026-□TB05</b>	1	1 unit
32	--	15	<b>18.5</b>	29	--	--	20	<b>25</b>	<b>S0</b>	5	<b>3RW4027-□TB05</b>	1	1 unit
38	--	18.5	<b>22</b>	34	--	--	25	<b>30</b>	<b>S0</b>	5	<b>3RW4028-□TB05</b>	1	1 unit
45	--	22	<b>30</b>	42	--	--	30	<b>40</b>	<b>S2</b>	5	<b>3RW4036-□TB05</b>	1	1 unit
63	--	30	<b>37</b>	58	--	--	40	<b>50</b>	<b>S2</b>	5	<b>3RW4037-□TB05</b>	1	1 unit
72	--	37	<b>45</b>	62	--	--	40	<b>60</b>	<b>S2</b>	5	<b>3RW4038-□TB05</b>	1	1 unit
80	--	45	<b>55</b>	73	--	--	50	<b>60</b>	<b>S3</b>	5	<b>3RW4046-□TB05</b>	1	1 unit
106	--	55	<b>75</b>	98	--	--	75	<b>75</b>	<b>S3</b>	5	<b>3RW4047-□TB05</b>	1	1 unit

**Article No. supplement for connection types**

- Screw terminals
- Spring-loaded terminals<sup>2)</sup>

<sup>1)</sup> Soft starter  $U_e$  200 to 480 V with screw terminals: Standard delivery time SD = 1 day (d).

<sup>2)</sup> Main connection from size S2: screw terminals.

**Note:**

For the constraints for the motor outputs specified here, see page 7/7.

1  
2

# Basic Performance Soft Starters

## 3RW40 soft starters > Accessories

### Selection and ordering data

Conductor cross-section			Tightening torque	For soft starters size	SD	Article No.	Price per PU	PU (UNIT, SET, M)	PS*
Solid or stranded	Finely stranded with end sleeve	AWG cables, solid or stranded							
mm <sup>2</sup>	mm <sup>2</sup>	AWG	Nm	d					

#### Three-phase infeed terminals



3RV2925-5AB

2.5 ... 25	2.5 ... 16	10 ... 4	3 ... 4	<b>S0</b> (3RW402.)		<b>3RV2925-5AB</b>		1	1 unit
------------	------------	----------	---------	------------------------	--	--------------------	--	---	--------

For soft starters		Version	SD	Article No.	Price per PU	PU (UNIT, SET, M)	PS*
Type	Size						
			d				

#### Auxiliary terminals



3RT2946-4F

Auxiliary terminals, 3-pole			SD	Article No.	Price per PU	PU (UNIT, SET, M)	PS*
3RW404.	Size	Description					
	<b>S3</b>	For connection of auxiliary and control cables (0.5 ... 2.5 mm <sup>2</sup> ) to the main conductor terminals	5	<b>3RT2946-4F</b>		1	1 unit

#### Covers for soft starters



3RT2936-4EA2

Terminal covers for box terminals			SD	Article No.	Price per PU	PU (UNIT, SET, M)	PS*
3RW403.	Size	Description					
	<b>S2</b>	Additional touch protection to be fitted at the box terminals (two units required per device)	▶	<b>3RT2936-4EA2</b>		1	1 unit
3RW404.	<b>S3</b>			<b>3RT2946-4EA2</b>		1	1 unit

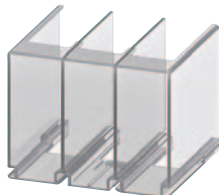

3RT1946-4EA1

Terminal covers for cable lugs and busbar connections			SD	Article No.	Price per PU	PU (UNIT, SET, M)	PS*
3RW404.	Size	Description					
	<b>S3</b>	For complying with the voltage clearances and as touch protection if box terminal is removed (two units required per device)	5	<b>3RT1946-4EA1</b>		1	1 unit



3RW4900-0PB10

Sealing covers			SD	Article No.	Price per PU	PU (UNIT, SET, M)	PS*
3RW402. to 3RW404.	Size	Description					
	<b>S0, S2, S3</b>	--	5	<b>3RW4900-0PB10</b>		1	1 unit

# Basic Performance Soft Starters

## 3RW40 soft starters > Accessories

For motor starter protectors	For soft starters	Version	SD	Article No.	Price per PU	PU (UNIT, SET, M)	PS*
Size	Size		d				

### Standard mounting rail adapters



3RA2932-1CA00

<b>S2</b>	<b>S2</b>	For mechanical fixing of motor starter protector and soft starter; for snapping onto standard mounting rail or for screw fixing <b>Single-unit packaging</b>	2	<b>3RA2932-1CA00</b>		1	1 unit
-----------	-----------	---	---	----------------------	--	---	--------

For soft starters	SD	Article No.	Price per PU	PU (UNIT, SET, M)	PS*
Type	d				
Size					

### Fans (to increase switching frequency and for device mounting in positions different to the standard position)



3RW49...-8VB00

3RW402.	<b>S0</b>	▶	<b>3RW4928-8VB00</b>	1	1 unit
3RW403., 3RW404.	<b>S2, S3</b>	▶	<b>3RW4947-8VB00</b>	1	1 unit

For soft starters	Motor starter protectors	SD	Article No.	Price per PU	PU (UNIT, SET, M)	PS*
Type	Size	d				

### Link modules to motor starter protectors<sup>1)</sup>

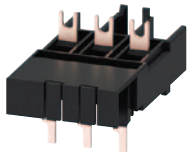

3RA2921-1BA00

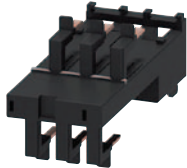

3RA2921-2GA00

3RW402.	<b>S0</b>	<b>S00/S0</b>	2	<b>3RA2921-1BA00</b>	1	1 unit
3RW4036	<b>S2</b>	<b>S2</b>	▶	<b>3RA2931-1AA00</b>	1	1 unit
3RW404.	<b>S3</b>	<b>S3</b>	▶	<b>3RA1941-1AA00</b>	1	1 unit

3RW402.	<b>S0</b>	<b>S0</b>	2	<b>3RA2921-2GA00</b>	1	1 unit
---------	-----------	-----------	---	----------------------	---	--------

#### Screw terminals



#### Spring-loaded terminals



<sup>1)</sup> Can be used in size S0 up to 32 A.  
Can be used in size S2 up to 65 A in combination with 3RA2932-1CA00 standard mounting rail adapter (specially for soft starters).  
Can be used in size S3 only with mounting plate.

Version	SD	Article No.	Price per PU	PU (UNIT, SET, M)	PS*
	d				

### Tools for opening spring-loaded terminals in sizes S00 and S0



3RA2908-1A

<b>Screwdrivers</b> For all SIRIUS devices with spring-loaded terminals Length approx. 200 mm, 3.0 mm x 0.5 mm, titanium gray/black, partially insulated	2	<b>3RA2908-1A</b>		1	1 unit
---	---	-------------------	--	---	--------

#### Spring-loaded terminals



### Blank labels

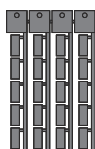

3RT2900-1SB20

<b>Unit labeling plates<sup>1)</sup></b> For SIRIUS devices 20 mm x 7 mm, titanium gray	20	<b>3RT2900-1SB20</b>		100	340 units
---	----	----------------------	--	-----	-----------

<sup>1)</sup> PC labeling systems for individual inscription of unit labeling plates are available from: murrplastik Systemtechnik GmbH (see page 16/14).

# Basic Performance Soft Starters

## 3RW30 soft starters > General data

### Overview

#### More information

Homepage, see [www.usa.siemens.com/soft-starter](http://www.usa.siemens.com/soft-starter)  
 Industry Mall, see [www.siemens.com/product?3RW](http://www.siemens.com/product?3RW)  
 TIA Selection Tool Cloud (TST Cloud), see <https://www.siemens.com/tstcloud/?node=3rw30>

Simulation Tool for Soft Starters (STS), see page 7/7 or <https://support.industry.siemens.com/cs/ww/en/view/101494917>  
 SIRIUS Soft Starter ES (TIA Portal), see page 14/5



The SIRIUS 3RW30 Basic Performance soft starters are suitable for soft starting of three-phase asynchronous motors.

Thanks to two-phase control, not only is the current kept at minimum values in all three phases throughout the entire starting time, but disturbing direct current components are also eliminated. This not only enables the two-phase starting of motors from 1.5 to 75HP @ 480V but also avoids the current and torque peaks which occur e.g. with wye-delta starters.

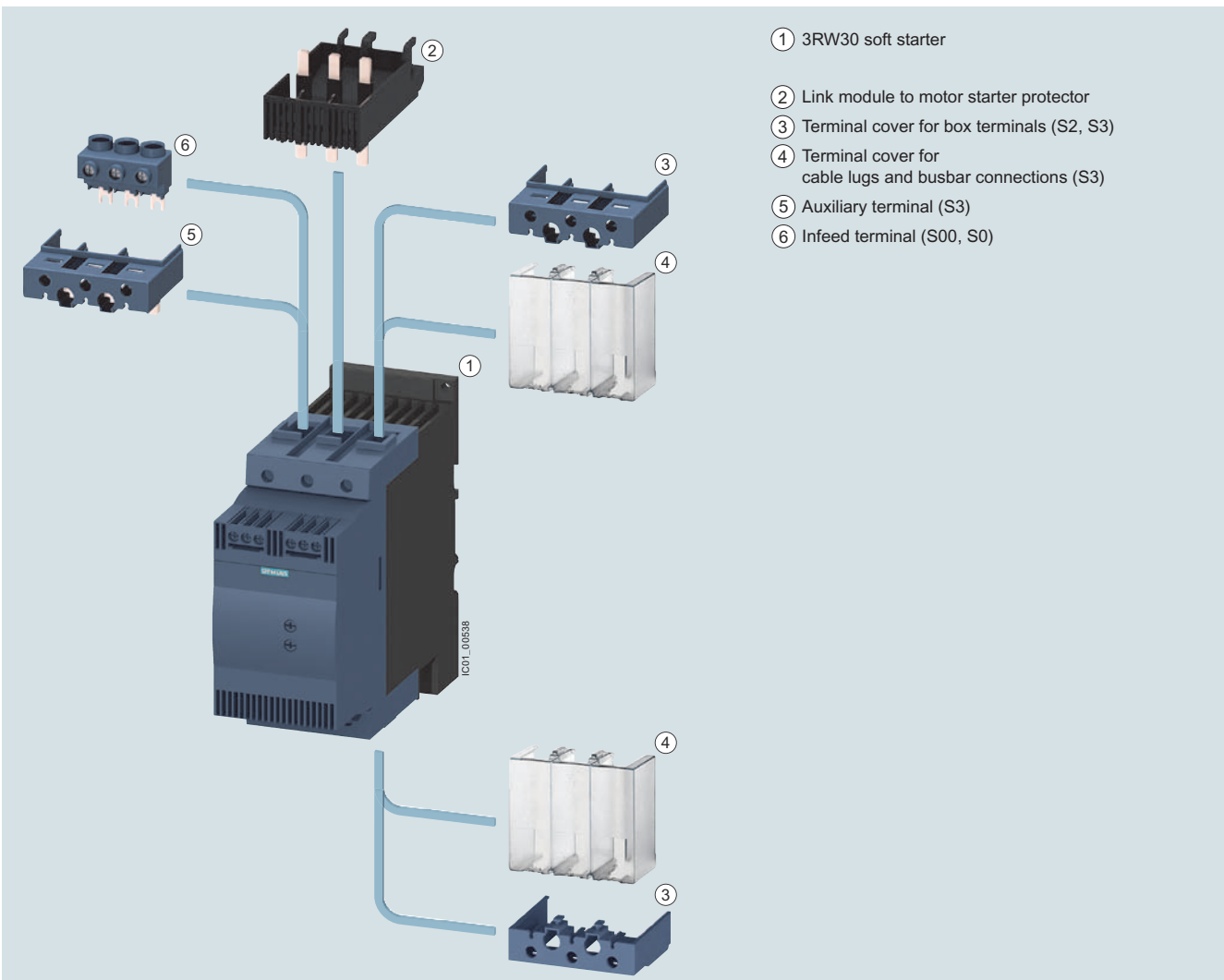

- ① 3RW30 soft starter
- ② Link module to motor starter protector
- ③ Terminal cover for box terminals (S2, S3)
- ④ Terminal cover for cable lugs and busbar connections (S3)
- ⑤ Auxiliary terminal (S3)
- ⑥ Infeed terminal (S00, S0)

3RW30 Basic Performance soft starters with accessories (see page 7/103)

### Benefits



Product characteristics / function	Performance features / benefits
Small and compact design	Space-saving, clearly arranged control panel layout
Parameterization using potentiometers	Simple and fast commissioning
Integrated in the SIRIUS modular system	Link modules to motor starter protectors
Hybrid switching devices and two-phase motor control	Minimum power loss and optimized motor control by avoiding DC components

### Technical specifications

#### More information

Equipment Manual "SIRIUS 3RW30/3RW40 Soft Starters", see <https://support.industry.siemens.com/cs/ww/en/view/38752095>  
 FAQs, see <https://support.industry.siemens.com/cs/ww/en/ps/16213/faq>

Catalog LV 10, see [www.siemens.com/lowvoltage/lv10](http://www.siemens.com/lowvoltage/lv10)

Type		3RW301.	3RW302.	3RW303.	3RW304.	
<b>Mechanics and environment</b>						
<b>Mounting dimensions (W x H x D)</b> • Screw terminals • Spring-loaded terminals		mm	45 x 95 x 151	45 x 125 x 151	55 x 144 x 168	70 x 160 x 186
		mm	45 x 117 x 151	45 x 150 x 151	55 x 144 x 168	70 x 160 x 186
<b>Permissible ambient temperature</b>						
During operation	°C	-25 ... +60; (derating from +40)				
During storage	°C	-40 ... +80				
<b>Weight</b>	kg	0.58	0.69	1.20	1.71	
<b>Permissible mounting position<sup>1)</sup></b> (auxiliary fan not possible)						
<b>Installation type<sup>1)</sup></b>	Stand-alone installation					
		① ≥ 15 mm (≥ 0.59 in) ② ≥ 40 mm (≥ 1.56 in) ③ ≥ 60 mm (≥ 2.36 in)		① ≥ 30 mm (≥ 1.18 in) ② ≥ 40 mm (≥ 1.56 in) ③ ≥ 60 mm (≥ 2.36 in)		
<b>Permissible installation altitude</b>	m	5 000 (Derating from 1 000, see <a href="#">characteristic curve on page 7/7</a> )				
<b>Degree of protection</b>		IP00				

<sup>1)</sup> In the case of deviations, please observe derating, see [Equipment Manual](#) in the chapter "Configuring".

# Basic Performance Soft Starters

## 3RW30 soft starters > General data

Type	Terminal		3RW301., 3RW302.		3RW303., 3RW304.	
<b>Control electronics</b>						
<b>Rated values</b>						
Rated control supply voltage	A1/A2	V	24	110 ... 230	24	110 ... 230
• Tolerance		%	20	-15/+10	20	-15/+10
Rated frequency		Hz	50/60			
• Tolerance		%	± 10			

Type			3RW301.	3RW302.	3RW303.	3RW304.
<b>Power electronics</b>						
<b>Rated operational voltage</b>		V AC	200 ... 480			
Tolerance		%	-15/+10			
<b>Rated frequency</b>		Hz	50/60			
Tolerance		%	10			
<b>Uninterrupted duty</b> at 40 °C (% of $I_e$ )		%	115			
<b>Minimum load</b> (% of $I_e$ )		%	10 (at least 1 A)			
<b>Maximum cable length</b> between soft starter and motor		m	300			

Type			3RW3013	3RW3014	3RW3016	3RW3017	3RW3018
<b>Power electronics</b>							
<b>Load rating with rated operational current <math>I_e</math></b>							
• According to IEC and UL/CSA <sup>1)</sup> , individual mounting at 40/50/60 °C, AC-53a	A		3.6/3.3/3	6.5/6/5.5	9/8/7	12.5/12/11	17.6/17/14
<b>Power loss</b>		W					
• In operation after completed starting with uninterrupted rated operational current (40 °C) approx.	W		0.25	0.5	1	2	4
• During starting with 300% $I_M$ (40 °C)	W		24	52	80	80	116
<b>Permissible rated motor current and starts per hour</b>							
• For normal starting (CLASS 10) at 40/50 °C							
- Rated motor current $I_M^{(2)}$ , start-up time 3 s	A		3.6/3.3	6.5/6.0	9/8	12.5/12.0	17.6/17.0
- Starts per hour <sup>3)</sup>	1/h		200/150	87/60	50/50	85/70	62/46
- Rated motor current $I_M^{(2)}$ , start-up time 4 s	A		3.6/3.3	6.5/6.0	9/8	12.5/12.0	17.6/17.0
- Starts per hour <sup>3)</sup>	1/h		150/100	64/46	35/35	62/47	45/32

<sup>1)</sup> Measurement at 60 °C according to UL/CSA not required.  
<sup>2)</sup> At 300%  $I_M$ ,  $T_U = 40/50$  °C.  
<sup>3)</sup> For intermittent duty S4 with ON period = 30%,  $T_U = 40/50$  °C, stand-alone installation vertical. The quoted switching frequencies do not apply for automatic mode.

Type			3RW3026	3RW3027	3RW3028
<b>Power electronics</b>					
<b>Load rating with rated operational current <math>I_e</math></b>					
• According to IEC and UL/CSA <sup>1)</sup> , individual mounting at 40/50/60 °C, AC-53a	A		25.3/23/21	32.2/29/26	38/34/31
<b>Power loss</b>		W			
• In operation after completed starting with uninterrupted rated operational current (40 °C) approx.	W		8	13	19
• During starting with 300% $I_M$ (40 °C)	W		188	220	256
<b>Permissible rated motor current and starts per hour</b>					
• For normal starting (CLASS 10) at 40/50 °C					
- Rated motor current $I_M^{(2)}$ , start-up time 3 s	A		25/23	32/29	38/34
- Starts per hour <sup>3)</sup>	1/h		23/23	23/23	19/19
- Rated motor current $I_M^{(2)}$ , start-up time 4 s	A		25/23	32/29	38/34
- Starts per hour <sup>3)</sup>	1/h		15/15	16/16	12/12

<sup>1)</sup> Measurement at 60 °C according to UL/CSA not required.  
<sup>2)</sup> At 300%  $I_M$ ,  $T_U = 40/50$  °C.  
<sup>3)</sup> For intermittent duty S4 with ON period = 30%,  $T_U = 40/50$  °C, stand-alone installation vertical. The quoted switching frequencies do not apply for automatic mode. Factors for permissible switching frequency with deviating mounting position, direct mounting, side-by-side mounting, see [Equipment Manual in the chapter "Configuring"](#).

Type			3RW3036	3RW3037	3RW3038	3RW3046	3RW3047
<b>Power electronics</b>							
<b>Load rating with rated operational current <math>I_e</math></b>							
• According to IEC and UL/CSA <sup>1)</sup> , individual mounting at 40/50/60 °C, AC-53a	A		45/42/39	65/58/53	72/62.1/60	80/73/66	106/98/90
<b>Power loss</b>		W					
• In operation after completed starting with uninterrupted rated operational current (40 °C) approx.	W		6	12	15	12	21
• During starting with 300% $I_M$ (40 °C)	W		316	444	500	576	768
<b>Permissible rated motor current and starts per hour</b>							
• For normal starting (CLASS 10) at 40/50 °C							
- Rated motor current $I_M^{(2)}$ , start-up time 3 s	A		45/42	63/58	72/62	80/73	106/108
- Starts per hour <sup>3)</sup>	1/h		38/38	23/23	22/22	22/22	15/15
- Rated motor current $I_M^{(2)}$ , start-up time 4 s	A		45/42	63/58	72/62	80/73	106/98
- Starts per hour <sup>3)</sup>	1/h		26/26	15/15	15/15	15/15	10/10

<sup>1)</sup> Measurement at 60 °C according to UL/CSA not required.  
<sup>2)</sup> At 300%  $I_M$ ,  $T_U = 40/50$  °C.  
<sup>3)</sup> For intermittent duty S4 with ON period = 30%,  $T_U = 40/50$  °C, stand-alone installation vertical. The quoted switching frequencies do not apply for automatic mode.

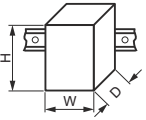
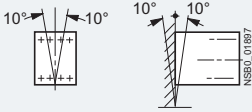

Type		3RW3003-1CB54	3RW3003-2CB54
<b>Mechanics and environment</b>			
<b>Mounting dimensions (W x H x D)</b> • Screw terminals • Spring-loaded terminals		mm mm	22.5 x 100 x 120 -- 22.5 x 101.6 x 120
<b>Permissible ambient temperature</b>			
During operation	°C	-25 ... +60; (derating from +40)	
During storage	°C	-40 ... +80	
<b>Weight</b>	kg	0.207	0.188
<b>Permissible mounting position</b>			
<b>Permissible installation altitude</b>	m	5 000 (Derating from 1 000, see characteristic curve on page 7/7)	
<b>Degree of protection</b> acc. to IEC 60529		IP00	
<b>Control electronics</b>			
<b>Rated values</b>			
Rated control supply voltage	V	24 ... 230 AC/DC	
• Tolerance	%	± 10	
Rated frequency at AC	Hz	50/60	
• Tolerance	%	± 10	
<b>Power electronics</b>			
<b>Rated operational voltage</b>	V AC	200 ... 400	
Tolerance	%	± 10	
<b>Rated frequency</b>	Hz	50/60	
Tolerance	%	± 10	
<b>Uninterrupted duty</b> (% of $I_e$ )	%	100	
<b>Minimum load</b> <sup>1)</sup> (% of $I_e$ ); at 40 °C	%	9	
<b>Maximum conductor length</b> between soft starter and motor	m	100 <sup>2)</sup>	
<b>Load rating with rated operational current <math>I_e</math></b>			
• According to IEC and UL/CSA, individual mounting at 40/50/60 °C, AC-53a	A	3/2.6/2.2	
• According to IEC and UL/CSA, side-by-side mounting at 40/50/60 °C, AC-53a	A	2.6/2.2/1.8	
<b>Power loss</b>			
• In operation after completed starting with uninterrupted rated operational current (40 °C) approx.	W	6.5	
• With utilization of maximum switching frequency	W	3	
<b>Permissible starts per hour (cannot be increased by using a fan)</b>			
• For intermittent duty S4 $T_U = 40$ °C, stand-alone installation vertical	1/h	1 500	
• ON period = 70% for 300% $I_e$	1/s	0.2	
<b>Dead time after uninterrupted duty</b> with $I_e$ before restart	s	0	

<sup>1)</sup> The rated motor current (specified on the motor's name plate) should at least amount to the specified percentage of the SIRIUS soft starter unit's rated operational current  $I_e$ .

<sup>2)</sup> If this value is exceeded, problems with line capacities may arise, which can result in false firing.

# Basic Performance Soft Starters

## 3RW30 soft starters > General data

### Motor feeders according to IEC with 3RV2 motor starter protectors (without semiconductor protection)

Type of coordination "1", CLASS 10, short-circuit breaking capacity  $I_q$  in kA, [see table](#)

Note:

For general recommendations for constructing motor feeders with soft starters, [see page 7/9](#).

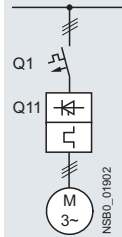

Soft starters	Motor starter protectors	
Q11	for 400 V systems	
Type	Q1	$I_q$ kA
Type of coordination "1"	Inline circuit	
<b>3RW3003</b>	3RV2011-1EA10	50
<b>3RW3013</b>	3RV2011-1FA10	5
<b>3RW3014</b>	3RV2011-1HA10	5
<b>3RW3016</b>	3RV2011-1JA10	5
<b>3RW3017</b>	3RV2011-1KA10	5
<b>3RW3018</b>	3RV2021-4BA10	5
<b>3RW3026</b>	3RV2021-4DA10	55
<b>3RW3027</b>	3RV2021-4EA10	55
<b>3RW3028</b>	3RV2021-4FA10	55
<b>3RW3036</b>	3RV2031-4WA10	10
<b>3RW3037</b>	3RV2031-4JA10	10
<b>3RW3038</b>	3RV2031-4KA10	10
<b>3RW3046</b>	3RV2041-4RA10	11
<b>3RW3047</b>	3RV2041-4MA10	11

Note:

The specified short-circuit breaking capacities  $I_q$  in kA are covered by combination tests. Smaller motor starter protectors/circuit breakers than those specified can be used at any time as smaller ones trip more quickly in the event of a short circuit (unchanged short-circuit breaking capacity) and thus protect the soft starter in any case. The dimensioning of the short-circuit components must, however, be suitable for the connected three-phase motor and the line protection for the cables used.

# Basic Performance Soft Starters

## 3RW30 soft starters > General data

### Motor feeders according to IEC with 3NA3 fuses

gG class full-range fuses for cable and line protection according to IEC 60269-2, without semiconductor protection

Type of coordination "1",  
short-circuit breaking capacity  $I_q = 65 \text{ kA}$

**Note:**

For general recommendations for constructing motor feeders with soft starters, [see page 7/9](#).

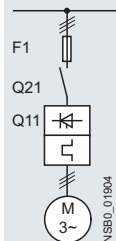

Soft starters	gG class fuse	Line contactor (optional)	
Q11	for systems up to 480 V	for systems up to 400 V	for systems up to 480 V
Type	F1	Q21	Q21
Type	Type	Type	Type
Type of coordination "1"	Inline circuit		
<span style="border: 1px solid black; padding: 2px;">T<sub>OC</sub> 1</span>			
<b>3RW3003</b> <sup>1)</sup>	3NA3805 <sup>2)</sup>	3RT2015	3RT2015
<b>3RW3013</b>	3NA3803-6	3RT2015	3RT2015
<b>3RW3014</b>	3NA3805-6	3RT2015	3RT2016
<b>3RW3016</b>	3NA3807-6	3RT2016	3RT2017
<b>3RW3017</b>	3NA3810-6	3RT2018	3RT2025
<b>3RW3018</b>	3NA3814-6	3RT2026	3RT2026
<b>3RW3026</b>	3NA3822-6	3RT2026	3RT2027
<b>3RW3027</b>	3NA3824-6	3RT2027	3RT2028
<b>3RW3028</b>	3NA3824-6	3RT2028	3RT2035
<b>3RW3036</b>	3NA3130-6	3RT2036	3RT2036
<b>3RW3037</b>	3NA3132-6	3RT2037	3RT2037
<b>3RW3038</b>	3NA3132-6	3RT2038	3RT2038
<b>3RW3046</b>	3NA3136-6	3RT2045	3RT2045
<b>3RW3047</b>	3NA3136-6	3RT2047	3RT2047

<sup>1)</sup>  $I_q = 50 \text{ kA}$  at 400 V.

<sup>2)</sup> 3NA3805-1 (NH00), 5SB261 (DIAZED), 5SE2201-6 (NEOZED).

**Note:**

The specified short-circuit breaking capacities  $I_q$  in kA are covered by combination tests. Smaller fuses than those specified can be used at any time as smaller ones trip more quickly in the event of a short circuit (unchanged short-circuit breaking capacity) and thus protect the soft starter in any case. The dimensioning of the short-circuit components must, however, be suitable for the connected three-phase motor and the line protection for the cables used.

## Basic Performance Soft Starters

## 3RW30 soft starters &gt; General data

**Motor feeders according to IEC with 3NE1 SITOR fuses**

gR class full-range fuses for semiconductor protection, cable and line protection

Type of coordination "2",  
short-circuit breaking capacity  $I_q = 65 \text{ kA}$

Note:

For general recommendations for constructing motor feeders with soft starters, [see page 7/9](#).

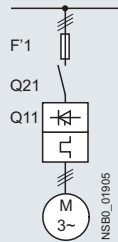

Soft starters	gG class fuse	Line contactor (optional)	
Q11	for systems up to 480 V	for systems up to 400 V	for systems up to 480 V
Type	F'1	Q21	Q21
Type	Type	Type	Type
Type of coordination "2"	<div style="border: 1px solid black; padding: 2px; display: inline-block;">T<sub>OC</sub> 2</div> <b>Inline circuit</b>		
<b>3RW3003<sup>1)</sup></b>	3NE1813-0 <sup>2)</sup>	3RT2015	3RT2015
<b>3RW3013</b>	3NE1813-0	3RT2015	3RT2015
<b>3RW3014</b>	3NE1813-0	3RT2015	3RT2016
<b>3RW3016</b>	3NE1813-0	3RT2016	3RT2017
<b>3RW3017</b>	3NE1813-0	3RT2018	3RT2025
<b>3RW3018</b>	3NE1814-0	3RT2026	3RT2026
<b>3RW3026</b>	3NE1803-0	3RT2026	3RT2027
<b>3RW3027</b>	3NE1020-2	3RT2027	3RT2028
<b>3RW3028</b>	3NE1020-2	3RT2028	3RT2035
<b>3RW3036</b>	3NE1020-2	3RT2036	3RT2036
<b>3RW3037</b>	3NE1820-0	3RT2037	3RT2037
<b>3RW3038</b>	3NE1820-0	3RT2038	3RT2038
<b>3RW3046</b>	3NE1021-0	3RT2045	3RT2045
<b>3RW3047</b>	3NE1022-0	3RT2047	3RT2047

<sup>1)</sup>  $I_q = 50 \text{ kA}$  at 400 V.

<sup>2)</sup> No SITOR fuse required!  
Alternatively: 3NA3803 (NH00), 5SB221 (DIAZED), 5SE2206 (NEOZED).

Note:

The specified short-circuit breaking capacities  $I_q$  in kA are covered by combination tests. Smaller fuses than those specified can be used at any time as smaller ones trip more quickly in the event of a short circuit (unchanged short-circuit breaking capacity) and thus protect the soft starter in any case. The dimensioning of the short-circuit components must, however, be suitable for the connected three-phase motor and the line protection for the cables used.

# Basic Performance Soft Starters

## 3RW30 soft starters > General data

### Motor feeders according to IEC with 3NE8 / 3NE4 / 3NE3 / 3NC fuses

aR class partial-range fuses for semiconductor protection

Type of coordination "2",  
short-circuit breaking capacity  $I_{q} = 65 \text{ kA}$

Note:

For general recommendations for constructing motor feeders with soft starters, [see page 7/9](#).

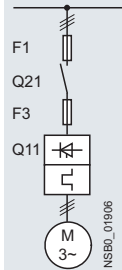

Soft starters	gG class fuse	aR class fuse	Cylindrical fuses	Line contactor (optional)
Q11 Type	for systems up to 480 V F1 Type	for systems up to 480 V F3 Type	for systems up to 480 V F3 Type	for systems up to 480 V Q21 Type
<b>Type of coordination "2"</b>	<b>Inline circuit</b>			
<b>3RW3003<sup>1)</sup></b>	3NA3805 <sup>2)</sup>	--	3NE8015-1	3NC1010
<b>3RW3013</b>	3NA3803-6	--	3NE4101	3NC2220
<b>3RW3014</b>	3NA3805-6	--	3NE4101	3NC2220
<b>3RW3016</b>	3NA3807-6	--	3NE4101	3NC2220
<b>3RW3017</b>	3NA3810-6	--	3NE4101	3NC2250
<b>3RW3018</b>	3NA3814-6	--	3NE4101	3NC2263
<b>3RW3026</b>	3NA3822-6	--	3NE4102	3NC2263
<b>3RW3027</b>	3NA3824-6	--	3NE4118	3NC2280
<b>3RW3028</b>	3NA3824-6	--	3NE4118	3NC2280
<b>3RW3036</b>	3NA3130-6	--	3NE4120	3NC2280
<b>3RW3037</b>	3NA3132-6	--	3NE4121	--
<b>3RW3038</b>	3NA3132-6	3NE3221	--	--
<b>3RW3046</b>	3NA3136-6	3NE3222	3NE8022-1	--
<b>3RW3047</b>	3NA3136-6	3NE3224	3NE8024-1	--

<sup>1)</sup>  $I_{q} = 50 \text{ kA}$  at 400 V.  
<sup>2)</sup> 3NA3805-1 (NH00), 5SB261 (DIAZED).

Note:

The specified short-circuit breaking capacities  $I_{q}$  in kA are covered by combination tests. Smaller fuses than those specified can be used at any time as smaller ones trip more quickly in the event of a short circuit (unchanged short-circuit breaking capacity) and thus protect the soft starter in any case. The dimensioning of the short-circuit components must, however, be suitable for the connected three-phase motor and the line protection for the cables used.

For CLASS 10 applications, as an alternative to the gG class full-range fuses for cable and line protection 3NA3 (F1), 3RV2 motor starter protectors/circuit breakers can also be used, possibly with reduced short-circuit breaking capacity ([see page 7/98](#)). In these cases, optional line contactors can be dispensed with.

# Basic Performance Soft Starters

3RW30 soft starters > Inline circuit **IE3/IE4 ready**

## Selection and ordering data

For simple starting conditions



3RW ambient temperature 40 °C				3RW ambient temperature 50 °C				Size	SD <sup>1)</sup>	Article No.	Price per PU	PU (UNIT, SET, M)	PS*
Rated values of three-phase motors				Rated values of three-phase motors									
Operational current $I_e$	Rating at operational voltage $U_e$			Operational current $I_e$	Rating at operational voltage $U_e$			d					
	230 V	400 V	500 V		200 V	230 V	460 V						575 V
A	kW	kW	kW	A	hp	hp	hp	hp					
<b>Rated operational voltage <math>U_e</math> 200 ... 480 V</b>													
3.6	0.75	<b>1.5</b>	--	3	0.5	0.5	<b>1.5</b>	--	<b>S00</b>	2	<b>3RW3013-□BB□4</b>	1	1 unit
6.5	1.5	<b>3</b>	--	6	1	1	<b>3</b>	--	<b>S00</b>	2	<b>3RW3014-□BB□4</b>	1	1 unit
9	2.2	<b>4</b>	--	8	2	2	<b>5</b>	--	<b>S00</b>	2	<b>3RW3016-□BB□4</b>	1	1 unit
12.5	3	<b>5.5</b>	--	12	3	3	<b>7.5</b>	--	<b>S00</b>	2	<b>3RW3017-□BB□4</b>	1	1 unit
17.6	4	<b>7.5</b>	--	17	3	3	<b>10</b>	--	<b>S00</b>	2	<b>3RW3018-□BB□4</b>	1	1 unit
25	5.5	<b>11</b>	--	23	5	5	<b>15</b>	--	<b>S0</b>	2	<b>3RW3026-□BB□4</b>	1	1 unit
32	7.5	<b>15</b>	--	29	7.5	7.5	<b>20</b>	--	<b>S0</b>	2	<b>3RW3027-□BB□4</b>	1	1 unit
38	11	<b>18.5</b>	--	34	10	10	<b>25</b>	--	<b>S0</b>	2	<b>3RW3028-□BB□4</b>	1	1 unit
45	11	<b>22</b>	--	42	10	15	<b>30</b>	--	<b>S2</b>	2	<b>3RW3036-□BB□4</b>	1	1 unit
63	18.5	<b>30</b>	--	58	15	20	<b>40</b>	--	<b>S2</b>	2	<b>3RW3037-□BB□4</b>	1	1 unit
72	22	<b>37</b>	--	62	20	20	<b>40</b>	--	<b>S2</b>	2	<b>3RW3038-□BB□4</b>	1	1 unit
80	22	<b>45</b>	--	73	20	25	<b>50</b>	--	<b>S3</b>	2	<b>3RW3046-□BB□4</b>	1	1 unit
106	30	<b>55</b>	--	98	30	30	<b>75</b>	--	<b>S3</b>	2	<b>3RW3047-□BB□4</b>	1	1 unit

### Article No. supplement for connection types

- Screw terminals
- Spring-loaded terminals<sup>2)</sup>



### Control supply voltage $U_s$

- 24 V AC/DC
- 110 ... 230 V AC/DC

Soft starters for easy starting conditions and high switching frequency, rated operational voltage  $U_e$  200 ... 400 V, rated control supply voltage  $U_s$  24 ... 230 V AC/DC

3	0.55	<b>1.1</b>	--	A	0.5	<b>0.5</b>	--	--	22.5 mm				
										▶	<b>3RW3003-1CB54</b>	1	1 unit
										▶	<b>3RW3003-2CB54</b>	1	1 unit

<sup>1)</sup> Soft starter  $U_e$  200 to 480 V with screw terminals: Standard delivery time SD = 1 day (d).

<sup>2)</sup> Main connection from size S2: screw terminals.







### Note:

For the constraints for the motor outputs specified here, see page 7/7.

## Selection and ordering data

### More information

Equipment Manual "SIRIUS 3RW30/3RW40 Soft Starters", see <https://support.industry.siemens.com/cs/ww/en/view/38752095>

Conductor cross-section		Tightening torque	For soft starters size	SD	Article No.	Price per PU	PU (UNIT, SET, M)	PS*
Solid or stranded	Finely stranded with end sleeve							
mm <sup>2</sup>	mm <sup>2</sup>	AWG	Nm	d				
<b>Three-phase infeed terminals</b>								
	2.5 ... 25	2.5 ... 16	10 ... 4	3 ... 4	S00 (3RW301.), S0 (3RW302.)		1	1 unit
3RV2925-5AB								
For soft starters				SD	Article No.	Price per PU	PU (UNIT, SET, M)	PS*
Type	Size			d				
<b>Auxiliary terminals</b>								
	<b>Auxiliary terminals, 3-pole</b>							
3RT2946-4F	3RW304.	S3		5	3RT2946-4F		1	1 unit
<b>Covers for soft starters</b>								
	<b>Terminal covers for box terminals</b>							
Additional touch protection to be fitted at the box terminals (two units required per device)								
3RT2946-4EA2	3RW303.	S2			3RT2936-4EA2		1	1 unit
	3RW304.	S3			3RT2946-4EA2		1	1 unit
	<b>Terminal covers for cable lugs and busbar connections</b>							
For complying with the voltage clearances and as touch protection if box terminal is removed (two units required per device)								
3RT1946-4EA1	3RW304.	S3		5	3RT1946-4EA1		1	1 unit
For motor starter protectors		For soft starters	Version	SD	Article No.	Price per PU	PU (UNIT, SET, M)	PS*
Size	Size			d				
<b>Mounting rails for mounting contactors for the customer assembly of 3RA21 load feeders with busbar adapters for 60 mm systems</b>								
	--	S0	For the discrete configuration of direct-on-line starters, an additional mounting rail is needed for the contactor in addition to the existing mounting rail on the busbar adapter for the motor starter protector.					
8US1998-7CB45			For pushing onto the device adapter, including fixing screws		2	8US1998-7CB45	1	10 units
<b>Standard mounting rail adapters</b>								
	S2	S2	For mechanical fixing of motor starter protector and soft starter; for snapping onto standard mounting rail or for screw fixing					
3RA2932-1CA00			<b>Single-unit packaging</b>		2	3RA2932-1CA00	1	1 unit

# Basic Performance Soft Starters

## 3RW30 soft starters > Accessories

For soft starters Type	Size	Motor starter protectors Size	SD	Article No.	Price per PU	PU (UNIT, SET, M)	PS*
------------------------	------	-------------------------------	----	-------------	--------------	-------------------	-----

### Link modules to motor starter protectors<sup>1)</sup>

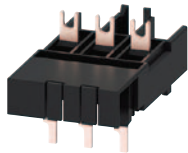

3RA2921-1BA00

3RW301.	<b>S00</b>	<b>S00</b>	2
3RW302.	<b>S0</b>	<b>S00/S0</b>	2
3RW3036	<b>S2</b>	<b>S2</b>	▶
3RW304.	<b>S3</b>	<b>S3</b>	▶

#### Screw terminals



<b>3RA2921-1BA00</b>	1	1 unit
<b>3RA2921-1BA00</b>	1	1 unit
<b>3RA2931-1AA00</b>	1	1 unit
<b>3RA1941-1AA00</b>	1	1 unit



3RA2921-2GA00

3RW301.	<b>S00</b>	<b>S00</b>	2
3RW302.	<b>S0</b>	<b>S0</b>	2

#### Spring-loaded terminals



<b>3RA2911-2GA00</b>	1	1 unit
<b>3RA2921-2GA00</b>	1	1 unit

<sup>1)</sup> Can be used in size S0 up to 32 A.  
 Can be used in size S2 up to 65 A in combination with 3RA2932-1CA00 standard mounting rail adapter (specially for soft starters).  
 Can be used in size S3 only on mounting plate.

Version	Functionality Functions	Use	SD	Article No.	Price per PU	PU (UNIT, SET, M)	PS*
---------	-------------------------	-----	----	-------------	--------------	-------------------	-----

### Covers and push-in lugs (only for 3RW3003)



3RP1902

<b>Sealable covers</b>	For securing against unauthorized adjustment of setting knobs	For devices with 1 or 2 CO contacts	5
------------------------	---	-------------------------------------	---

<b>3RP1902</b>	1	5 units
----------------	---	---------



3RP1903

<b>Push-in lugs for screw fixing</b>	--	For devices with 1 or 2 CO contacts	5
--------------------------------------	----	-------------------------------------	---

<b>3RP1903</b>	1	10 units
----------------	---	----------

Version	SD	Article No.	Price per PU	PU (UNIT, SET, M)	PS*
---------	----	-------------	--------------	-------------------	-----

### Tools for opening spring-loaded terminals in sizes S00 and S0



3RA2908-1A

<b>Screwdrivers</b>	For all SIRIUS devices with spring-loaded terminals		
	Length approx. 200 mm, 3.0 mm x 0.5 mm, titanium gray/black, partially insulated		2

#### Spring-loaded terminals



<b>3RA2908-1A</b>	1	1 unit
-------------------	---	--------

### Blank labels

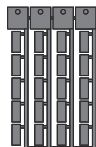

3RT2900-1SB20

<b>Unit labeling plates<sup>1)</sup></b>	For SIRIUS devices		
	20 mm x 7 mm, titanium gray		20

<b>3RT2900-1SB20</b>	100	340 units
----------------------	-----	-----------

<sup>1)</sup> PC labeling systems for individual inscription of unit labeling plates are available from: murrplastik Systemtechnik GmbH (see page 16/15).



# High Performance Soft Starters

For 3RW55/3RW55 Failsafe

Type of product	SD	Article No.	Price per PU	PU (UNIT, SET, M)	PS*
-----------------	----	-------------	--------------	-------------------	-----

### SIRIUS Soft Starter ES V16 Basic

**Basic Function Including Professional Trial License**  
 Engineering software,  
 Software download  
 6 languages (English, German, French, Italian, Spanish, Chinese)  
 Online functions via system interface  
 No cost to download:  
<https://support.industry.siemens.com/cs/document/109771657>

### SIRIUS Soft Starter ES V16 Professional



**Floating License for one User**  
 Engineering software,  
 Software and documentation on DVD  
 6 languages (English, German, French, Italian, Spanish, Chinese)  
 Online functions via system interface or PROFIBUS/PROFINET  
 • License Key on USB flash drive, includes DVD  
 • License Key download, without DVD

**Upgrade for Soft Starter ES 2007 Premium**

Floating License for one User  
 Engineering software,  
 Software and documentation on DVD  
 License Key on USB flash drive  
 6 languages (English, German, French, Italian, Spanish, Chinese)  
 Online functions via system interface or PROFIBUS/PROFINET

3ZS1320-6CC12-0YA5

**Hints:**

Licenses from Soft Starter ES Standard and Premium V14 to V15.1 can also be used for Soft Starter ES V16 Professional

Product designation	Manufacturer's Article No. of the soft starter	Type of product	SD	Article No.	Price per PU	PU (UNIT, SET, M)	PS*
---------------------	--	-----------------	----	-------------	--------------	-------------------	-----

### Fans



**Fan**  
 3RW551 (1x),  
 3RW552 (2x),  
 3RW553 (2x)  
 3RW554 (1x)  
 3RW555 (3x)

3RW5983-0FF00

### Terminals and terminal covers



**Box terminal block**  
 3RW552 (2x)

3RW5982-0TB00



**Removable control terminals**  
 3RW551.-1H... (2x),  
 3RW552.-1H... (2x),  
 3RW553.-6H... (2x),  
 3RW554.-6H... (2x),  
 3RW555.-6H... (2x)

3RW5980-1TR00

3RW551.-3H... (2x),  
 3RW552.-3H... (2x),  
 3RW553.-2H... (2x),  
 3RW554.-2H... (2x),  
 3RW555.-2H... (2x)

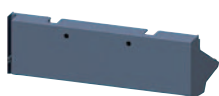

**Terminal cover**  
 3RW555

3RW5955-0TC20

7  
SOFT STARTERS





# High Performance Soft Starters

For 3RW55/3RW55 Failsafe

Product designation	Manufacturer's Article No. of the soft starter	Type of product	SD	Article No.	Price per PU	PU (UNIT, SET, M)	PS*
<b>Enclosure components</b>							
	<b>Cover for control cable duct</b>	3RW55...-HA..	Titanium gray	▶	<b>3RW5950-0GD20</b>	1	1 unit
3RW5950-0GD20		3RW55...-HF..	Yellow <b>NEW</b>	▶	<b>3RW5950-0GD30</b>	1	1 unit
							
3RW5950-0GD30							
	<b>Hinged cover</b>	3RW55	With cutout for High Feature HMI module	▶	<b>3RW5950-0GL30</b>	1	1 unit
3RW5950-0GL30							







# High Performance Soft Starters

For 3RW55/3RW55 Failsafe

Product designation	Manufacturer's Article No. of the soft starter	Type of product	SD	Article No.	Price per PU	PU (UNIT, SET, M)	PS*
<b>HMI modules</b>							
	<b>HMI module</b>	3RW55	High Feature	▶	<b>3RW5980-0HF00</b>	1	1 unit
3RW5980-0HF00							
	<b>Interface cover</b>	3RW55	--	▶	<b>3RW5980-0HL00</b>	1	1 unit
3RW5980-0HL00							
<b>Connection cable for installing the HMI module in the soft starter</b>							
	<b>Connection cable</b>	--	0.1 m, flat	▶	<b>3UF7931-0AA00-0</b>	1	1 unit
3UF7931-0AA00-0							
<b>Transport packaging</b>							
	<b>Transport packaging</b>	3RW551	--	▶	<b>3RW5951-0VY00</b>	1	1 unit
		3RW552, 3RW553	--	▶	<b>3RW5953-0VY00</b>	1	1 unit
		3RW554	--	▶	<b>3RW5954-0VY00</b>	1	1 unit
		3RW555	--	▶	<b>3RW5955-0VY00</b>	1	1 unit
3RW5953-0VY00							



# General Performance Soft Starters

For 3RW52

Product designation	Manufacturer's Article No. of the soft starter	Type of product	SD	Article No.	Price per PU	PU (UNIT, SET, M)	PS*
<b>Fans</b>							
 3RW5983-0FF00	<b>Fans</b>	3RW5216/17 (1x), 3RW5226/27 (2x), 3RW523 (2x)	--	▶	<b>3RW5983-0FF00</b>	1	1 unit
		3RW524 (1x)	--	▶	<b>3RW5984-0FF00</b>	1	1 unit
<b>Terminals</b>							
 3RW5982-0TB00	<b>Box terminal block</b>	3RW522 (2x)	--	▶	<b>3RW5982-0TB00</b>	1	1 unit
 3RW5980-1TR00	<b>Removable control terminals</b>	3RW521.-1.C., 3RW522.-1.C., 3RW523.-6.C., 3RW524.-6.C..	contains 2 blocks each with 6 terminals	▶	<b>Screw terminals</b>  <b>3RW5980-1TR00</b>	1	1 unit
		3RW521.-3.C., 3RW522.-3.C., 3RW523.-2.C., 3RW524.-2.C..	contains 2 blocks each with 6 terminals	▶	<b>Spring-loaded terminals</b>  <b>3RW5980-2TR00</b>	1	1 unit
<b>Enclosure components</b>							
 3RW5953-0GB00	<b>Enclosure base</b>	3RW522, 3RW523	--	▶	<b>3RW5953-0GB00</b>	1	1 unit
		3RW524	--	▶	<b>3RW5954-0GB00</b>	1	1 unit
 3RW5950-0GD20	<b>Cover for control cable duct</b>	3RW52	Titanium gray	▶	<b>3RW5950-0GD20</b>	1	1 unit







# General Performance Soft Starters

For 3RW52

Product designation	Manufacturer's Article No. of the soft starter	Type of product	SD	Article No.	Price per PU	PU (UNIT, SET, M)	PS*
<b>Enclosure components</b>							
	<b>Hinged cover</b>	3RW52	Without cutout ▶	<b>3RW5950-0GL20</b>		1	1 unit
3RW5950-0GL20							
<b>Transport packaging</b>							
	<b>Transport packaging</b>	3RW521	-- ▶	<b>3RW5951-0VY00</b>		1	1 unit
		3RW522, 3RW523	-- ▶	<b>3RW5953-0VY00</b>		1	1 unit
		3RW524	-- ▶	<b>3RW5954-0VY00</b>		1	1 unit
3RW5953-0VY00							

# Basic Performance Soft Starters

For 3RW50 **NEW**

Product designation	Manufacturer's Article No. of the soft starter	Type of product	SD	Article No.	Price per PU	PU (UNIT, SET, M)	PS*
<b>Fan</b>							
 <p>3RW5905-0FF00</p>	<b>Fan</b>	3RW505 (1x)	--	▶	<b>3RW5905-0FF00</b>	1	1 unit
		3RW507 (1x)	--	▶	<b>3RW5907-0FF00</b>	1	1 unit
<b>Terminals</b>							
 <p>3RW5980-1TR00</p>	<b>Removable control terminals</b>	3RW50..-6.B..	contains 2 blocks each with 6 terminals	▶	<b>Screw terminals</b>  <b>3RW5980-1TR00</b>	1	1 unit
		3RW50..-2.B..	contains 2 blocks each with 6 terminals	▶	<b>Spring-loaded terminals</b>  <b>3RW5980-2TR00</b>	1	1 unit
<b>Enclosure components</b>							
 <p>3RW5900-0GL00</p>	<b>Hinged cover</b>	3RW50	--	▶	<b>3RW5900-0GL00</b>	1	1 unit
<b>Transport packaging</b>							
 <p>3RW5905-0VY00</p>	<b>Transport packaging</b>	3RW505	--	▶	<b>3RW5905-0VY00</b>	1	1 unit
		3RW507	--	▶	<b>3RW5907-0VY00</b>	1	1 unit

# 3RW Soft Starters

Soft starters for enclosed applications

## Overview

The family of 3RW40 and 3RW44 softstarters are available in stand alone enclosed control designs for smooth starting and stopping of standard NEMA design B three phase inductive motors, thus eliminating physical stresses to the system and load while minimizing starting current. These pre-engineered enclosed designs offer convenience and flexibility in and UL/CSA certified offering. Enclosed styles are available in combination and non-combination configurations through 600HP and system voltages of 200V, 230V, 480V, and 600V.

The Class 73 offers either the 3RW40 or 3RW44 in a non-combination style offering. These non-combination styles come standard with a choice of Type 1, 3R, 12, 4 NEMA rated enclosure, a control transformer, Sirius softstarter with built-in overload and bypass, line side power terminal block, and a reset pushbutton. The enclosed offering can be powerfully matched with a wide variety of factory modified options such as pushbutton control, pilot lights, metering and other control options such as isolation contactors and emergency start bypass starters. 3RW44 enclosed styles are also available with optional through the door keypad and Profibus communication.

The Class 74 offering includes all of the features of the Class 73 in a combination style design. Standard options are either a circuit breaker or fusible disconnect providing short circuit protection and soft starting in one package.

## Application

The Class 73/74 product is a fully enclosed solid state reduced voltage starter designed for a wide variety of industrial applications. The enclosed softstarter offerings are ideal for new as well as existing applications where total motor controls is required.

Proper selection based on application data is made simple following these easy steps:

- Select proper RVSS by application
  - Select the 3RW40 versus the 3RW44 using the application info provided in the open section of the catalog
- Select the rating chart for normal starting or sever duty starting
  - Normal starting is rated at 350% of rated motor current IM for 10 seconds and based on starts per hour – representative of a class 20 application.
  - Severe starting is rated at 350% of rated motor current Im for 20 seconds and based on starts per hour – representative of a Class 20 application
- Select model using Motor nameplate data
  - Identify correct motor voltage column
  - Select rate current or HP row
  - Find ordering number under desired enclosure type column (e.g. NEMA 1)
  - Select appropriate system voltage
- Select factory modification on page 6/40<sup>1)</sup>

Example:  
3RW44, N12, CB disconnect, 460V, 200HP with a start/stop and red run light

Order No.  
74MT34BFAP A1 FC

## Product Nomenclature

Class 73 and 74 Enclosed Soft Starters

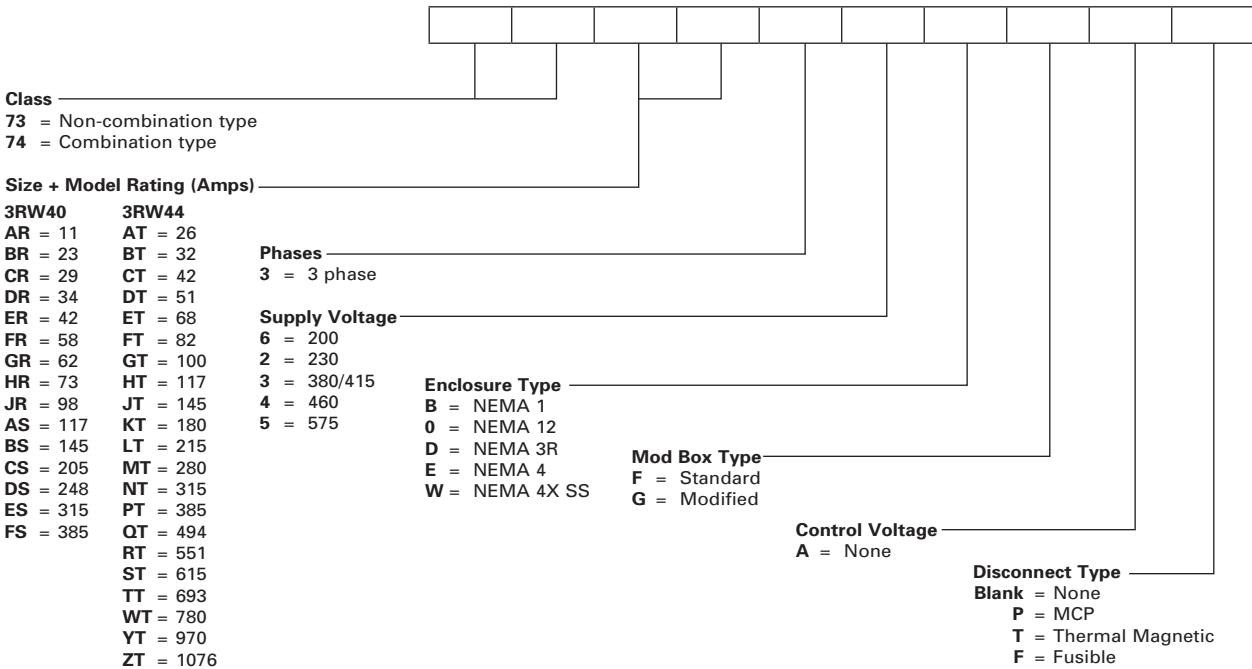

<sup>1)</sup> Some modifications will require a larger 'Modified' box than the standard box e.g. Isolation contactor, space heater, etc. See page 7/124 for instructions.

# 3RW Soft Starters

## 3RW40 Size S0-S3 Non-Combo



**3RW40 Enclosed features:**

- Available in NEMA 1,12,3R,4, and 4 stainless steel
- Compact size
- Built-in Bypass contactor
- Voltage ramp up and ramp down
- Current limit adjustment of 125 - 550%
- Internal overload class 10,15,or 20
- Internal self protection
- Fault monitoring
- Isolation Contactor

### Ordering Information

- ▶ Enclosed devices should be ordered by the FLA of the motor.
- ▶ The 3RW40 is designed for normal starting applications.
- ▶ For factory modifications see page 7/124.
- ▶ For dimensional drawings see page 7/125.

Class 73 non-combination starters include:

- NEMA rated enclosure
- 3RW40 Sirius softstarter with built-in OL and bypass
- Control Circuit Transformer
- Line side power terminal block
- Reset button
- Isolation Contactor

Ideal applications for 3RW40 enclosed softstarters

- Fans
- Pumps
- Easy starting loads starting in less than 10 seconds

Class 73 starters are built to UL and CSA standards

## 3RW40 for Standard Applications

### Enclosed Non-Combination (Starter Only)

Rated Operating Current	MAX HP <sup>①</sup>				KW	Class 10 Light Duty (350% * Ie for 10s) <sup>②</sup>									
	200V	230V	460V	575V		380V	OPEN Style (Starter Only)	NEMA 1	List Price \$	NEMA 3R	List Price \$	NEMA 12	List Price \$	NEMA 4	List Price \$
11	3	3	7.5	—	6	3RW4024-1BB14	73AR3_BFA		73AR3_DFA		73AR3_OFA		73AR3_EFA		73AR3_WFA
23	5	7.5	15	—	13	3RW4026-1BB14	73BR3_BFA		73BR3_DFA		73BR3_OFA		73BR3_EFA		73BR3_WFA
29	7.5	10	20	—	16	3RW4027-1BB14	73CR3_BFA		73CR3_DFA		73CR3_OFA		73CR3_EFA		73CR3_WFA
34	10	10	25	—	18	3RW4028-1BB14	73DR3_BFA		73DR3_DFA		73DR3_OFA		73DR3_EFA		73DR3_WFA
42	10	15	30	—	23	3RW4036-1BB14	73ER3_BFA		73ER3_DFA		73ER3_OFA		73ER3_EFA		73ER3_WFA
58	15	20	40	—	31	3RW4037-1BB14	73FR3_BFA		73FR3_DFA		73FR3_OFA		73FR3_EFA		73FR3_WFA
62	20	20	40	—	33	3RW4038-1BB14	73GR3_BFA		73GR3_DFA		73GR3_OFA		73GR3_EFA		73GR3_WFA
73	20	25	50	—	39	3RW4046-1BB14	73HR3_BFA		73HR3_DFA		73HR3_OFA		73HR3_EFA		73HR3_WFA
98	30	30	75	—	52	3RW4047-1BB14	73JR3_BFA		73JR3_DFA		73JR3_OFA		73JR3_EFA		73JR3_WFA
						200V	6		6		6		6		6
						230V	2		2		2		2		2
						380V	3		3		3		3		3
						460V	4		4		4		4		4

① Starter size is dependent on the nameplate Full Load Amps (FLA) rating of the motor. HPs are for reference only. Enclosed ratings are at 40°C

② Starter selection is dependent on type of application. Ie = FLA rating of motor



# 3RW Soft Starters

## Enclosed 3RW40



**3RW40 Enclosed features:**

- Available in NEMA 1, 12, 3R, 4, and 4 stainless steel
- Compact size
- Built-in bypass contactor
- Voltage ramp up and ramp down
- Current limit adjustment of 125 - 550%
- Internal overload class 10, 15, or 20
- Internal self protection
- Fault monitoring

### Ordering Information

- ▶ Enclosed devices should be ordered by the FLA of the motor.
- ▶ The 3RW40 is designed for normal starting applications (Class 10 applications).
- ▶ For factory modifications see page 7/124.
- ▶ For dimensional drawings see page 7/125.

- Class 73 non-combination starters include:
- NEMA rated enclosure
  - 3RW40 Sirius softstarter with built-in OL and bypass
  - Control circuit transformer
  - Line side power terminal block
  - Reset button

Ideal applications for 3RW40 enclosed softstarters:

- Fans
- Pumps
- Building/construction machines
- Presses
- Escalators
- Transport systems
- Air conditioning systems
- Ventilators
- Assembly lines

Class 73 starters are built to UL and CSA standards.

For all technical information, please consult the 2006 Industrial Controls Catalog or contact your local sales support center.

## 3RW40 for Standard Applications

### Enclosed Non-Combination (Starter Only)

Rated Operating Current	MAX HP <sup>①</sup>				KW	Class 10 Light Duty (350% * Im for 10s) <sup>②</sup>									
	200V	230V	460V	575V		380V	OPEN Style (Starter Only)	NEMA 1	List Price \$	NEMA 3R	List Price \$	NEMA 12	List Price \$	NEMA 4	List Price \$
117	30	40	75	—	56	3RW4055-6BB34	73AS3_BFA		73AS3_DFA		73AS3_OFA		73AS3_EFA		73AS3_WFA
145	40	50	100	—	75	3RW4056-6BB34	73BS3_BFA		73BS3_DFA		73BS3_OFA		73BS3_EFA		73BS3_WFA
205	60	75	150	—	112	3RW4073-6BB34	73CS3_BFA		73CS3_DFA		73CS3_OFA		73CS3_EFA		73CS3_WFA
248	75	100	200	—	149	3RW4074-6BB34	73DS3_BFA		73DS3_DFA		73DS3_OFA		73DS3_EFA		73DS3_WFA
315	100	125	250	—	186	3RW4075-6BB34	73ES3_BFA		73ES3_DFA		73ES3_OFA		73ES3_EFA		73ES3_WFA
385	125	150	300	—	224	3RW4076-6BB34	73FS3_BFA		73FS3_DFA		73FS3_OFA		73FS3_EFA		73FS3_WFA
						200V	6		6		6		6		6
						230V	2		2		2		2		2
						380V	3		3		3		3		3
						460V	4		4		4		4		4
117	—	—	75	100	—	3RW4055-6BB35	73AS35BFA		73AS35DFA		73AS350FA		73AS35EFA		73AS35WFA
145	—	—	100	150	—	3RW4056-6BB35	73BS35BFA		73BS35DFA		73BS350FA		73BS35EFA		73BS35WFA
205	—	—	150	200	—	3RW4073-6BB35	73CS35BFA		73CS35DFA		73CS350FA		73CS35EFA		73CS35WFA
248	—	—	200	250	—	3RW4074-6BB35	73DS35BFA		73DS35DFA		73DS350FA		73DS35EFA		73DS35WFA
315	—	—	250	300	—	3RW4075-6BB35	73ES35BFA		73ES35DFA		73ES350FA		73ES35EFA		73ES35WFA
385	—	—	300	400	—	3RW4076-6BB35	73FS35BFA		73FS35DFA		73FS350FA		73FS35EFA		73FS35WFA

### Enclosed Non-Combination (Starter Only)

Rated Operating Current	MAX HP <sup>①</sup>				KW	Class 20 Severe Duty (350% * Ie for 20s) <sup>②</sup>									
	200V	230V	460V	575V		380V	OPEN Style (Starter Only)	NEMA 1	List Price \$	NEMA 3R	List Price \$	NEMA 12	List Price \$	NEMA 4	List Price \$
112	30	40	75	—	56	3RW4055-6BB34	73AS3_BFA		73AS3_DFA		73AS3_OFA		73AS3_EFA		73AS3_WFA
132	40	50	100	—	75	3RW4056-6BB34	73BS3_BFA		73BS3_DFA		73BS3_OFA		73BS3_EFA		73BS3_WFA
185	60	60	125	—	93	3RW4073-6BB34	73CS3_BFA		73CS3_DFA		73CS3_OFA		73CS3_EFA		73CS3_WFA
205	60	75	150	—	112	3RW4074-6BB34	73DS3_BFA		73DS3_DFA		73DS3_OFA		73DS3_EFA		73DS3_WFA
280	75	100	200	—	149	3RW4075-6BB34	73ES3_BFA		73ES3_DFA		73ES3_OFA		73ES3_EFA		73ES3_WFA
340	100	125	250	—	186	3RW4076-6BB34	73FS3_BFA		73FS3_DFA		73FS3_OFA		73FS3_EFA		73FS3_WFA
						200V	6		6		6		6		6
						230V	2		2		2		2		2
						380V	3		3		3		3		3
						460V	4		4		4		4		4
112	—	—	75	75	—	3RW4055-6BB35	73AS35BFA		73AS35DFA		73AS350FA		73AS35EFA		73AS35WFA
132	—	—	100	125	—	3RW4056-6BB35	73BS35BFA		73BS35DFA		73BS350FA		73BS35EFA		73BS35WFA
185	—	—	125	150	—	3RW4073-6BB35	73CS35BFA		73CS35DFA		73CS350FA		73CS35EFA		73CS35WFA
205	—	—	150	200	—	3RW4074-6BB35	73DS35BFA		73DS35DFA		73DS350FA		73DS35EFA		73DS35WFA
280	—	—	200	250	—	3RW4075-6BB35	73ES35BFA		73ES35DFA		73ES350FA		73ES35EFA		73ES35WFA
340	—	—	250	300	—	3RW4076-6BB35	73FS35BFA		73FS35DFA		73FS350FA		73FS35EFA		73FS35WFA

① Starter size is dependent on the nameplate Full Load Amps (FLA) rating of the motor. HPs are for reference only. Enclosed ratings are at 40°C.

② Starter selection is dependent on type of application. Im = FLA rating of motor.

# 3RW Soft Starters

## 3RW40 – Size S0-S3 Circuit Breaker



**3RW40 Enclosed features:**

- Available in NEMA 1, 12, 3R, 4, and 4 stainless steel
- Compact size
- Built-in Bypass contactor
- Voltage ramp up and ramp down
- Current limit adjustment of 125 - 550%
- Internal overload class 10, 15, or 20
- Internal self protection
- Fault monitoring
- Isolation Contactor

### Ordering Information

- ▶ Enclosed devices should be ordered by the FLA of the motor.
- ▶ The 3RW40 is designed for normal starting applications.
- ▶ For factory modifications see page 7/124.
- ▶ For dimensional drawings see page 7/125.

- Class 74 non-combination starters include:
- NEMA rated enclosure
  - Circuit Breaker disconnect with shunt trip
  - 3RW40 Sirius softstarter with built-in OL and bypass
  - Control Circuit Transformer
  - Isolation Contactor

Ideal applications for 3RW40 enclosed softstarters

- Fans
- Pumps
- Easy starting loads starting in less than 10 seconds

Class 74 starters are built to UL and CSA standards

### 3RW40 for Standard Applications

#### Enclosed Circuit Breaker Combination (Starter With Circuit Breaker Disconnect)

Rated Operating Current	MAX HP <sup>①</sup>				KW	Class 10 Light Duty (350% * Ie for 10s) <sup>②</sup>										
	200V	230V	460V	575V		380V	OPEN Style (Starter Only)	NEMA 1	List Price \$	NEMA 3R	List Price \$	NEMA 12	List Price \$	NEMA 4	List Price \$	NEMA 4/4X Stainless Steel
11	3	3	7.5	—	6	3RW4024-1BB14	74AR3_BFAP		74AR3_DFAP		74AR3_OFAP		74AR3_EFAP		74AR3_WFAP	
23	5	7.5	15	—	13	3RW4026-1BB14	74BR3_BFAP		74BR3_DFAP		74BR3_OFAP		74BR3_EFAP		74BR3_WFAP	
29	7.5	10	20	—	16	3RW4027-1BB14	74CR3_BFAP		74CR3_DFAP		74CR3_OFAP		74CR3_EFAP		74CR3_WFAP	
34	10	10	25	—	18	3RW4028-1BB14	74DR3_BFAP		74DR3_DFAP		74DR3_OFAP		74DR3_EFAP		74DR3_WFAP	
42	10	15	30	—	23	3RW4036-1BB14	74ER3_BFAP		74ER3_DFAP		74ER3_OFAP		74ER3_EFAP		74ER3_WFAP	
58	15	20	40	—	31	3RW4037-1BB14	74FR3_BFAP		74FR3_DFAP		74FR3_OFAP		74FR3_EFAP		74FR3_WFAP	
62	20	20	40	—	33	3RW4038-1BB14	74GR3_BFAP		74GR3_DFAP		74GR3_OFAP		74GR3_EFAP		74GR3_WFAP	
73	20	25	50	—	39	3RW4046-1BB14	74HR3_BFAP		74HR3_DFAP		74HR3_OFAP		74HR3_EFAP		74HR3_WFAP	
98	30	30	75	—	52	3RW4047-1BB14	74JR3_BFAP		74JR3_DFAP		74JR3_OFAP		74JR3_EFAP		74JR3_WFAP	
							200V	6		6		6		6		6
							230V	2		2		2		2		2
							380V	3		3		3		3		3
							460V	4		4		4		4		4

① Starter size is dependent on the nameplate Full Load Amps (FLA) rating of the motor. HPs are for reference only. Enclosed ratings are at 40°C

② Starter selection is dependent on type of application. Ie = FLA rating of motor

Enclosed 3RW44



- 3RW40 Enclosed features:
- Available in NEMA 1, 12, 3R, 4, and 4 stainless steel
  - Compact size
  - Built-in bypass contactor
  - Voltage ramp up and ramp down
  - Current limit adjustment of 125 - 550%
  - Internal overload class 10, 15, or 20
  - Internal self protection
  - Fault monitoring

Ordering Information

- Enclosed devices should be ordered by the FLA of the motor.
  - The 3RW40 is designed for normal starting applications (Class 10 applications).
  - For factory modifications see page 7/124.
  - For dimensional drawings see page 7/125.
- Class 74 non-combination starters include:
- NEMA rated enclosure
  - Circuit breaker disconnect with shunt trip
  - 3RW40 Sirius softstarter with built-in OL and bypass
  - Control circuit transformer

Ideal applications for 3RW40 enclosed softstarters:

- Fans
- Pumps
- Building/construction machines
- Presses
- Escalators
- Transport systems
- Air conditioning systems
- Ventilators
- Assembly lines

Class 74 starters are built to UL and CSA standards.

For all technical information, please consult the 2006 Industrial Controls Catalog or contact your local sales support center.

3RW40 for Standard Applications

Enclosed Circuit Breaker Combination (Starter with Circuit Breaker Disconnect)

Rated Operating Current	MAX HP <sup>①</sup>				KW	Class 10 Light Duty (350% * Im for 10s) <sup>②</sup>											
	200V	230V	460V	575V		380V	OPEN Style (Starter Only)	NEMA 1	List Price \$	NEMA 3R	List Price \$	NEMA 12	List Price \$	NEMA 4	List Price \$	NEMA 4/4X Stainless Steel	List Price \$
117	30	40	75	—	56	3RW4055-6BB34	74AS3_BFAP		74AS3_DFAP		74AS3_OFAP		74AS3_EFAP		74AS3_WFAP		
145	40	50	100	—	75	3RW4056-6BB34	74BS3_BFAP		74BS3_DFAP		74BS3_OFAP		74BS3_EFAP		74BS3_WFAP		
205	60	75	150	—	112	3RW4073-6BB34	74CS3_BFAP		74CS3_DFAP		74CS3_OFAP		74CS3_EFAP				
248	75	100	200	—	149	3RW4074-6BB34	74DS3_BFAP		74DS3_DFAP		74DS3_OFAP		74DS3_EFAP				
315	100	125	250	—	186	3RW4075-6BB34	74ES3_BFAP		74ES3_DFAP		74ES3_OFAP		74ES3_EFAP				
385	125	150	300	—	224	3RW4076-6BB34	74FS3_BFAP		74FS3_DFAP		74FS3_OFAP		74FS3_EFAP				
						200V	6		6		6		6		6		
						230V	2		2		2		2		2		
						380V	3		3		3		3		3		
						460V	4		4		4		4		4		
117	—	—	75	100	—	3RW4055-6BB35	74AS35BFAP		74AS35DFAP		74AS350FAP		74AS35EFAP		74AS35WFAP		
145	—	—	100	150	—	3RW4056-6BB35	74BS35BFAP		74BS35DFAP		74BS350FAP		74BS35EFAP		74BS35WFAP		
205	—	—	150	200	—	3RW4073-6BB35	74CS35BFAP		74CS35DFAP		74CS350FAP		74CS35EFAP				
248	—	—	200	250	—	3RW4074-6BB35	74DS35BFAP		74DS35DFAP		74DS350FAP		74DS35EFAP				
315	—	—	250	300	—	3RW4075-6BB35	74ES35BFAP		74ES35DFAP		74ES350FAP		74ES35EFAP				
385	—	—	300	400	—	3RW4076-6BB35	74FS35BFAP		74FS35DFAP		74FS350FAP		74FS35EFAP				

Enclosed Circuit Breaker Combination (Starter with Circuit Breaker Disconnect)

Rated Operating Current	MAX HP <sup>①</sup>				KW	Class 20 Severe Duty (350% * Ie for 20s) <sup>②</sup>											
	200V	230V	460V	575V		380V	OPEN Style (Starter Only)	NEMA 1	List Price \$	NEMA 3R	List Price \$	NEMA 12	List Price \$	NEMA 4	List Price \$	NEMA 4/4X Stainless Steel	List Price \$
112	30	40	75	—	56	3RW4055-6BB34	74AS3_BFAP		74AS3_DFAP		74AS3_OFAP		74AS3_EFAP		74AS3_WFAP		
132	40	50	100	—	75	3RW4056-6BB34	74BS3_BFAP		74BS3_DFAP		74BS3_OFAP		74BS3_EFAP		74BS3_WFAP		
185	60	60	125	—	93	3RW4073-6BB34	74CS3_BFAP		74CS3_DFAP		74CS3_OFAP		74CS3_EFAP				
205	60	75	150	—	112	3RW4074-6BB34	74DS3_BFAP		74DS3_DFAP		74DS3_OFAP		74DS3_EFAP				
280	75	100	200	—	149	3RW4075-6BB34	74ES3_BFAP		74ES3_DFAP		74ES3_OFAP		74ES3_EFAP				
340	100	125	250	—	186	3RW4076-6BB34	74FS3_BFAP		74FS3_DFAP		74FS3_OFAP		74FS3_EFAP				
						200V	6		6		6		6		6		
						230V	2		2		2		2		2		
						380V	3		3		3		3		3		
						460V	4		4		4		4		4		
112	—	—	75	75	—	3RW4055-6BB35	74AS35BFAP		74AS35DFAP		74AS350FAP		74AS35EFAP		74AS35WFAP		
132	—	—	100	125	—	3RW4056-6BB35	74BS35BFAP		74BS35DFAP		74BS350FAP		74BS35EFAP		74BS35WFAP		
185	—	—	125	150	—	3RW4073-6BB35	74CS35BFAP		74CS35DFAP		74CS350FAP		74CS35EFAP				
205	—	—	150	200	—	3RW4074-6BB35	74DS35BFAP		74DS35DFAP		74DS350FAP		74DS35EFAP				
280	—	—	200	250	—	3RW4075-6BB35	74ES35BFAP		74ES35DFAP		74ES350FAP		74ES35EFAP				
340	—	—	250	300	—	3RW4076-6BB35	74FS35BFAP		74FS35DFAP		74FS350FAP		74FS35EFAP				

① Starter size is dependent on the nameplate Full Load Amps (FLA) rating of the motor. HPs are for reference only. Enclosed ratings are at 40°C.

② Starter selection is dependent on type of application. Im = FLA rating of motor.

# 3RW Soft Starters

## 3RW40 – Size S0-S3 Fusible



- 3RW40 Enclosed features:
- Available in NEMA 1, 12, 3R, 4, and 4 stainless steel
  - Compact size
  - Built-in Bypass contactor
  - Voltage ramp up and ramp down
  - Current limit adjustment of 125 - 550%
  - Internal overload class 10,15,or 20
  - Internal self protection
  - Fault monitoring
  - Isolation Contactor

### Ordering Information

- ▶ Enclosed devices should be ordered by the FLA of the motor.
- ▶ The 3RW40 is designed for normal starting applications.
- ▶ For factory modifications see page 7/124.
- ▶ For dimensional drawings see page 7/125.

Ideal applications for 3RW40 enclosed softstarters

- Fans
- Pumps
- Easy starting loads starting in less than 10 seconds

Class 74 starters are built to UL and CSA standards

Class 73 non-combination starters include:

- NEMA rated enclosure
- Fusible Disconnect
- 3RW40 Sirius softstarter with built-in OL and bypass
- Control Circuit Transformer
- Isolation Contactor

## 3RW40 for Standard Applications

### Enclosed Fusible Combination (Starter With Fusible Disconnect)

Rated Operating Current	MAX HP <sup>①</sup>				KW	Class 10 Light Duty (350% * I <sub>e</sub> for 10s) <sup>②</sup>										
	200V	230V	460V	575V		380V	OPEN Style (Starter Only)	NEMA 1	List Price \$	NEMA 3R	List Price \$	NEMA 12	List Price \$	NEMA 4	List Price \$	NEMA 4/4X Stainless Steel
11	3	3	7.5	—	6	3RW4024-1BB14	74AR3_BFAF		74AR3_DFAF		74AR3_OFAP		74AR3_EFAF		74AR3_WFAF	
23	5	7.5	15	—	13	3RW4026-1BB14	74BR3_BFAF		74BR3_DFAF		74BR3_OFAP		74BR3_EFAF		74BR3_WFAF	
29	7.5	10	20	—	16	3RW4027-1BB14	74CR3_BFAF		74CR3_DFAF		74CR3_OFAP		74CR3_EFAF		74CR3_WFAF	
34	10	10	25	—	18	3RW4028-1BB14	74DR3_BFAF		74DR3_DFAF		74DR3_OFAP		74DR3_EFAF		74DR3_WFAF	
42	10	15	30	—	23	3RW4036-1BB14	74ER3_BFAF		74ER3_DFAF		74ER3_OFAP		74ER3_EFAF		74ER3_WFAF	
58	15	20	40	—	31	3RW4037-1BB14	74FR3_BFAF		74FR3_DFAF		74FR3_OFAP		74FR3_EFAF		74FR3_WFAF	
62	20	20	40	—	33	3RW4038-1BB14	74GR3_BFAF		74GR3_DFAF		74GR3_OFAP		74GR3_EFAF		74GR3_WFAF	
73	20	25	50	—	39	3RW4046-1BB14	74HR3_BFAF		74HR3_DFAF		74HR3_OFAP		74HR3_EFAF		74HR3_WFAF	
98	30	30	75	—	52	3RW4047-1BB14	74JR3_BFAF		74JR3_DFAF		74JR3_OFAP		74JR3_EFAF		74JR3_WFAF	
						200V	6		6		6		6		6	
						230V	2		2		2		2		2	
						380V	3		3		3		3		3	
						460V	4		4		4		4		4	

① Starter size is dependent on the nameplate Full Load Amps (FLA) rating of the motor. HPs are for reference only. Enclosed ratings are at 40°C

② Starter selection is dependent on type of application. I<sub>e</sub> = FLA rating of motor

Enclosed 3RW44



- 3RW40 Enclosed features:
- Available in NEMA 1, 12, 3R, 4, and 4 stainless steel
  - Compact size
  - Built-in bypass contactor
  - Voltage ramp up and ramp down
  - Current limit adjustment of 125 - 550%
  - Internal overload class 10, 15, or 20
  - Internal self protection
  - Fault monitoring

Ordering Information

- Enclosed devices should be ordered by the FLA of the motor.
- The 3RW40 is designed for normal starting applications (Class 10 applications).
- For factory modifications see page 7/124.
- For dimensional drawings see page 7/125.

Class 74 combination starters include:

- NEMA rated enclosure
- Fusible disconnect
- 3RW40 Sirius softstarter with built-in OL and bypass
- Control circuit transformer

Ideal applications for 3RW40 enclosed softstarters:

- Fans
- Pumps
- Building/construction machines
- Presses
- Escalators
- Transport systems
- Air conditioning systems
- Ventilators
- Assembly lines

Class 74 starters are built to UL and CSA standards.

For all technical information, please consult the 2006 Industrial Controls Catalog or contact your local sales support center.

3RW40 for Standard Applications

Enclosed Fusible Combination (Starter with Fusible Disconnect)

Rated Operating Current	MAX HP <sup>①</sup>				KW	Class 10 Light Duty (350% * Im for 10s) <sup>②</sup>										
	200V	230V	460V	575V		380V	OPEN Style (Starter Only)	NEMA 1	List Price \$	NEMA 3R	List Price \$	NEMA 12	List Price \$	NEMA 4	List Price \$	NEMA 4/4X Stainless Steel
117	30	40	75	—	56	3RW4055-6BB34	74AS3_BFAF		74AS3_DFAF		74AS3_0FAF		74AS3_EFAF		74AS3_WFAF	
145	40	50	100	—	75	3RW4056-6BB34	74BS3_BFAF		74BS3_DFAF		74BS3_0FAF		74BS3_EFAF		74BS3_WFAF	
205	60	75	150	—	112	3RW4073-6BB34	74CS3_BFAF		74CS3_DFAF		74CS3_0FAF		74CS3_EFAF			
248	75	100	200	—	149	3RW4074-6BB34	74DS3_BFAF		74DS3_DFAF		74DS3_0FAF		74DS3_EFAF			
315	100	125	250	—	186	3RW4075-6BB34	74ES3_BFAF		74ES3_DFAF		74ES3_0FAF		74ES3_EFAF			
385	125	150	300	—	224	3RW4076-6BB34	74FS3_BFAF		74FS3_DFAF		74FS3_0FAF		74FS3_EFAF			
						200V	6		6		6		6		6	
						230V	2		2		2		2		2	
						380V	3		3		3		3		3	
						460V	4		4		4		4		4	
117	—	—	75	100	—	3RW4055-6BB35	74AS35BFAF		74AS35DFAF		74AS350FAF		74AS35EFAF		74AS35WFAF	
145	—	—	100	150	—	3RW4056-6BB35	74BS35BFAF		74BS35DFAF		74BS350FAF		74BS35EFAF		74BS35WFAF	
205	—	—	150	200	—	3RW4073-6BB35	74CS35BFAF		74CS35DFAF		74CS350FAF		74CS35EFAF			
248	—	—	200	250	—	3RW4074-6BB35	74DS35BFAF		74DS35DFAF		74DS350FAF		74DS35EFAF			
315	—	—	250	300	—	3RW4075-6BB35	74ES35BFAF		74ES35DFAF		74ES350FAF		74ES35EFAF			
385	—	—	300	400	—	3RW4076-6BB35	74FS35BFAF		74FS35DFAF		74FS350FAF		74FS35EFAF			

Enclosed Fusible Combination (Starter with Fusible Disconnect)

Rated Operating Current	MAX HP <sup>①</sup>				KW	Class 20 Severe Duty (350% * Ie for 20s) <sup>②</sup>										
	200V	230V	460V	575V		380V	OPEN Style (Starter Only)	NEMA 1	List Price \$	NEMA 3R	List Price \$	NEMA 12	List Price \$	NEMA 4	List Price \$	NEMA 4/4X Stainless Steel
112	30	40	75	—	56	3RW4055-6BB34	74AS3_BFAF		74AS3_DFAF		74AS3_0FAF		74AS3_EFAF		74AS3_WFAF	
132	40	50	100	—	75	3RW4056-6BB34	74BS3_BFAF		74BS3_DFAF		74BS3_0FAF		74BS3_EFAF		74BS3_WFAF	
185	60	60	125	—	93	3RW4073-6BB34	74CS3_BFAF		74CS3_DFAF		74CS3_0FAF		74CS3_EFAF			
205	60	75	150	—	112	3RW4074-6BB34	74DS3_BFAF		74DS3_DFAF		74DS3_0FAF		74DS3_EFAF			
280	75	100	200	—	149	3RW4075-6BB34	74ES3_BFAF		74ES3_DFAF		74ES3_0FAF		74ES3_EFAF			
340	100	125	250	—	186	3RW4076-6BB34	74FS3_BFAF		74FS3_DFAF		74FS3_0FAF		74FS3_EFAF			
						200V	6		6		6		6		6	
						230V	2		2		2		2		2	
						380V	3		3		3		3		3	
						460V	4		4		4		4		4	
112	—	—	75	75	—	3RW4055-6BB35	74AS35BFAF		74AS35DFAF		74AS350FAF		74AS35EFAF		74AS35WFAF	
132	—	—	100	125	—	3RW4056-6BB35	74BS35BFAF		74BS35DFAF		74BS350FAF		74BS35EFAF		74BS35WFAF	
185	—	—	125	150	—	3RW4073-6BB35	74CS35BFAF		74CS35DFAF		74CS350FAF		74CS35EFAF			
205	—	—	150	200	—	3RW4074-6BB35	74DS35BFAF		74DS35DFAF		74DS350FAF		74DS35EFAF			
280	—	—	200	250	—	3RW4075-6BB35	74ES35BFAF		74ES35DFAF		74ES350FAF		74ES35EFAF			
340	—	—	250	300	—	3RW4076-6BB35	74FS35BFAF		74FS35DFAF		74FS350FAF		74FS35EFAF			

① Starter size is dependent on the nameplate Full Load Amps (FLA) rating of the motor. HPs are for reference only. Enclosed ratings are at 40°C.

② Starter selection is dependent on type of application. Im = FLA rating of motor.

Enclosed 3RW44



3RW44 Enclosed features:

- Available in NEMA 1, 12, 3R, 4, and 4 stainless steel
- Compact size
- Built-in bypass contactor
- Multiple starting/stopping techniques including torque control
- Internal overload class 5, 10, 15, 20, or 30
- Built-in graphical LCD keypad
- Internal self protection
- Fault monitoring
- 3 parameter sets
- Communication capable via opt. Profibus module
- Programmable inputs and outputs
- External keypad available

Ordering Information

- Enclosed devices should be ordered by the FLA of the motor.
- The 3RW44 is designed for normal starting applications.
- For factory modifications see page 7/124.
- For dimensional drawings see page 7/125.

Class 73 non-combination starters include:

- NEMA rated enclosure
- 3RW44 Sirius softstarter with built-in OL and bypass
- Control circuit transformer
- Reset button

Ideal applications for 3RW44 enclosed softstarters:

- Fans
- Pumps
- Conveying systems and lifts
- Hydraulics
- Machine tools
- Mills saws
- Crushers and grinders
- Mixers
- HVAC systems

The 3RW44 severe duty rating table should be applied for high inertia applications such rock crushers, chippers, screw compressors, ect.

Class 73 starters are built to UL and CSA standards.

3RW44 For High Feature Applications

Enclosed Non-Combination (Starter Only)

Rated Operating Current	MAX HP <sup>①</sup>				KW 380V	Class 10 Light Duty (350% * Im for 10s) <sup>②</sup>										
	200V	230V	460V	575V		OPEN Style (Starter Only)	NEMA 1	List Price \$	NEMA 3R	List Price \$	NEMA 12	List Price \$	NEMA 4	List Price \$	NEMA 4/4X Stainless Steel	List Price \$
26	7.5	7.5	15	—	12	3RW4422-1BC34	73AT3_BFA	73AT3_DFA	73AT3_OFA	73AT3_EFA	73AT3_WFA					
32	10	10	20	—	15	3RW4423-1BC34	73BT3_BFA	73BT3_DFA	73BT3_OFA	73BT3_EFA	73BT3_WFA					
42	10	15	25	—	19	3RW4424-1BC34	73CT3_BFA	73CT3_DFA	73CT3_OFA	73CT3_EFA	73CT3_WFA					
51	15	15	30	—	22	3RW4425-1BC34	73DT3_BFA	73DT3_DFA	73DT3_OFA	73DT3_EFA	73DT3_WFA					
68	20	25	50	—	37	3RW4426-1BC34	73ET3_BFA	73ET3_DFA	73ET3_OFA	73ET3_EFA	73ET3_WFA					
82	25	30	60	—	45	3RW4427-1BC34	73FT3_BFA	73FT3_DFA	73FT3_OFA	73FT3_EFA	73FT3_WFA					
100	30	30	75	—	56	3RW4434-6BC34	73GT3_BFA	73GT3_DFA	73GT3_OFA	73GT3_EFA	73GT3_WFA					
117	30	40	75	—	56	3RW4435-6BC34	73HT3_BFA	73HT3_DFA	73HT3_OFA	73HT3_EFA	73HT3_WFA					
145	40	50	100	—	75	3RW4436-6BC34	73JT3_BFA	73JT3_DFA	73JT3_OFA	73JT3_EFA	73JT3_WFA					
180	60	60	125	—	93	3RW4443-6BC34	73KT3_BFA	73KT3_DFA	73KT3_OFA	73KT3_EFA	73KT3_WFA					
215	60	75	150	—	112	3RW4444-6BC34	73LT3_BFA	73LT3_DFA	73LT3_OFA	73LT3_EFA	73LT3_WFA					
280	75	100	200	—	149	3RW4445-6BC34	73MT3_BFA	73MT3_DFA	73MT3_OFA	73MT3_EFA	73MT3_WFA					
315	100	125	250	—	186	3RW4446-6BC34	73NT3_BFA	73NT3_DFA	73NT3_OFA	73NT3_EFA	73NT3_WFA					
385	125	150	300	—	224	3RW4447-6BC34	73PT3_BFA	73PT3_DFA	73PT3_OFA	73PT3_EFA	73PT3_WFA					
494	150	200	400	—	298	3RW4453-6BC34	73QT3_BFA	73QT3_DFA	73QT3_OFA	73QT3_EFA	73QT3_WFA					
551	150	200	450	—	336	3RW4454-6BC34	73RT3_BFA	73RT3_DFA	73RT3_OFA	73RT3_EFA	73RT3_WFA					
615	200	250	500	—	373	3RW4455-6BC34	73ST3_BFA	73ST3_DFA	73ST3_OFA	73ST3_EFA	73ST3_WFA					
693	200	250	550	—	410	3RW4456-6BC34	73TT3_BFA	73TT3_DFA	73TT3_OFA	73TT3_EFA	73TT3_WFA					
780	200	250	600	—	447	3RW4457-6BC34	73WT3_BFA	73WT3_DFA	73WT3_OFA	73WT3_EFA	73WT3_WFA					
970	350	350	800	—	597	3RW4465-6BC34	73YT3_BFA	73YT3_DFA	73YT3_OFA	73YT3_EFA	73YT3_WFA					
1076	350	400	900	—	972	3RW4466-6BC34	73ZT3_BFA	73ZT3_DFA	73ZT3_OFA	73ZT3_EFA	73ZT3_WFA					
						200V	6	6	6	6	6					
						230V	2	2	2	2	2					
						380V	3	3	3	3	3					
						460V	4	4	4	4	4					
26	—	—	15	20	—	3RW4422-1BC35	73AT35BFA	73AT35DFA	73AT35OFA	73AT35EFA	73AT35WFA					
32	—	—	20	25	—	3RW4423-1BC35	73BT35BFA	73BT35DFA	73BT35OFA	73BT35EFA	73BT35WFA					
42	—	—	25	30	—	3RW4424-1BC35	73CT35BFA	73CT35DFA	73CT35OFA	73CT35EFA	73CT35WFA					
51	—	—	30	40	—	3RW4425-1BC35	73DT35BFA	73DT35DFA	73DT35OFA	73DT35EFA	73DT35WFA					
68	—	—	50	50	—	3RW4426-1BC35	73ET35BFA	73ET35DFA	73ET35OFA	73ET35EFA	73ET35WFA					
82	—	—	60	75	—	3RW4427-1BC35	73FT35BFA	73FT35DFA	73FT35OFA	73FT35EFA	73FT35WFA					
100	—	—	75	75	—	3RW4434-6BC35	73GT35BFA	73GT35DFA	73GT35OFA	73GT35EFA	73GT35WFA					
117	—	—	75	100	—	3RW4435-6BC35	73HT35BFA	73HT35DFA	73HT35OFA	73HT35EFA	73HT35WFA					
145	—	—	100	125	—	3RW4436-6BC35	73JT35BFA	73JT35DFA	73JT35OFA	73JT35EFA	73JT35WFA					
180	—	—	125	150	—	3RW4443-6BC35	73KT35BFA	73KT35DFA	73KT35OFA	73KT35EFA	73KT35WFA					
215	—	—	150	200	—	3RW4444-6BC35	73LT35BFA	73LT35DFA	73LT35OFA	73LT35EFA	73LT35WFA					
280	—	—	200	250	—	3RW4445-6BC35	73MT35BFA	73MT35DFA	73MT35OFA	73MT35EFA	73MT35WFA					
315	—	—	250	300	—	3RW4446-6BC35	73NT35BFA	73NT35DFA	73NT35OFA	73NT35EFA	73NT35WFA					
385	—	—	300	400	—	3RW4447-6BC35	73PT35BFA	73PT35DFA	73PT35OFA	73PT35EFA	73PT35WFA					
494	—	—	400	500	—	3RW4453-6BC35	73QT35BFA	73QT35DFA	73QT35OFA	73QT35EFA	73QT35WFA					
551	—	—	450	600	—	3RW4454-6BC35	73RT35BFA	73RT35DFA	73RT35OFA	73RT35EFA	73RT35WFA					
615	—	—	500	700	—	3RW4455-6BC35	73ST35BFA	73ST35DFA	73ST35OFA	73ST35EFA	73ST35WFA					
693	—	—	550	750	—	3RW4456-6BC35	73TT35BFA	73TT35DFA	73TT35OFA	73TT35EFA	73TT35WFA					
780	—	—	600	850	—	3RW4457-6BC35	73WT35BFA	73WT35DFA	73WT35OFA	73WT35EFA	73WT35WFA					
970	—	—	800	1000	—	3RW4465-6BC35	73YT35BFA	73YT35DFA	73YT35OFA	73YT35EFA	73YT35WFA					
1076	—	—	900	1100	—	3RW4466-6BC35	73ZT35BFA	73ZT35DFA	73ZT35OFA	73ZT35EFA	73ZT35WFA					

① Starter size is dependent on the nameplate Full Load Amps (FLA) rating of the motor. HPs are for reference only. Enclosed ratings are at 40°C.

② Starter selection is dependent on type of application. Im = FLA rating of motor.

Enclosed 3RW44



3RW44 Enclosed features:

- Available in NEMA 1, 12, 3R, 4, and 4 stainless steel
- Compact size
- Built-in bypass contactor
- Multiple starting/stopping techniques including torque control
- Internal overload class 10, 15, or 20
- Built-in graphical LCD keypad
- Internal self protection
- Fault monitoring
- 3 parameter sets
- Communication capable via opt. Profibus module
- Programmable inputs and outputs
- External keypad available

Ordering Information

- ▶ Enclosed devices should be ordered by the FLA of the motor.
- ▶ The 3RW44 is designed for normal starting applications.
- ▶ For factory modifications see page 7/124.
- ▶ For dimensional drawings see page 7/125.

Class 73 non-combination starters include:

- NEMA rated enclosure
- 3RW44 Sirius softstarter with built-in OL and bypass
- Control circuit transformer
- Line side power terminal block
- Reset button

Ideal applications for 3RW44 enclosed softstarters:

- Fans
- Pumps
- Conveying systems and lifts
- Hydraulics
- Machine tools
- Mills saws
- Crushers and grinders
- Mixers
- HVAC systems

The 3RW44 severe duty rating table should be applied for high inertia applications such as rock crushers, chippers, screw compressors, ect.

Class 73 starters are built to UL and CSA standards.

3RW44 For High Feature Applications

Enclosed Non-Combination (Starter Only)

Rated Operating Current	MAX HP <sup>Ⓐ</sup>				KW	Class 20 Severe Duty (350% * Im for 20s) <sup>Ⓑ</sup>										
	200V	230V	460V	575V		380V	OPEN Style (Starter Only)	NEMA 1	List Price \$	NEMA 3R	List Price \$	NEMA 12	List Price \$	NEMA 4	List Price \$	NEMA 4/4X Stainless Steel
26	7.5	7.5	15	—	12	3RW4422-1BC34	73AT3_BFA		73AT3_DFA		73AT3_OFA		73AT3_EFA		73AT3_WFA	
32	10	10	20	—	15	3RW4423-1BC34	73BT3_BFA		73BT3_DFA		73BT3_OFA		73BT3_EFA		73BT3_WFA	
42	10	15	25	—	19	3RW4424-1BC34	73CT3_BFA		73CT3_DFA		73CT3_OFA		73CT3_EFA		73CT3_WFA	
51	15	15	30	—	22	3RW4425-1BC34	73DT3_BFA		73DT3_DFA		73DT3_OFA		73DT3_EFA		73DT3_WFA	
68	20	25	50	—	37	3RW4426-1BC34	73ET3_BFA		73ET3_DFA		73ET3_OFA		73ET3_EFA		73ET3_WFA	
82	25	30	60	—	45	3RW4427-1BC34	73FT3_BFA		73FT3_DFA		73FT3_OFA		73FT3_EFA		73FT3_WFA	
97	30	30	60	—	45	3RW4434-6BC34	73GT3_BFA		73GT3_DFA		73GT3_OFA		73GT3_EFA		73GT3_WFA	
113	30	40	75	—	56	3RW4435-6BC34	73HT3_BFA		73HT3_DFA		73HT3_OFA		73HT3_EFA		73HT3_WFA	
134	40	50	75	—	56	3RW4436-6BC34	73JT3_BFA		73JT3_DFA		73JT3_OFA		73JT3_EFA		73JT3_WFA	
175	50	60	100	—	75	3RW4443-6BC34	73KT3_BFA		73KT3_DFA		73KT3_OFA		73KT3_EFA		73KT3_WFA	
195	60	75	125	—	93	3RW4444-6BC34	73LT3_BFA		73LT3_DFA		73LT3_OFA		73LT3_EFA		73LT3_WFA	
243	75	75	150	—	112	3RW4445-6BC34	73MT3_BFA		73MT3_DFA		73MT3_OFA		73MT3_EFA		73MT3_WFA	
263	75	100	200	—	149	3RW4446-6BC34	73NT3_BFA		73NT3_DFA		73NT3_OFA		73NT3_EFA		73NT3_WFA	
326	100	125	250	—	186	3RW4447-6BC34	73PT3_BFA		73PT3_DFA		73PT3_OFA		73PT3_EFA		73PT3_WFA	
494	150	150	400	—	224	3RW4453-6BC34	73QT3_BFA		73QT3_DFA		73QT3_OFA		73QT3_EFA		73QT3_WFA	
551	150	200	450	—	298	3RW4454-6BC34	73RT3_BFA		73RT3_DFA		73RT3_OFA		73RT3_EFA		73RT3_WFA	
615	200	200	500	—	336	3RW4455-6BC34	73ST3_BFA		73ST3_DFA		73ST3_OFA		73ST3_EFA		73ST3_WFA	
634	200	250	500	—	373	3RW4456-6BC34	73TT3_BFA		73TT3_DFA		73TT3_OFA		73TT3_EFA		73TT3_WFA	
650	200	250	550	—	410	3RW4457-6BC34	73WT3_BFA		73WT3_DFA		73WT3_OFA		73WT3_EFA		73WT3_WFA	
880	300	350	700	—	522	3RW4465-6BC34	73YT3_BFA		73YT3_DFA		73YT3_OFA		73YT3_EFA		73YT3_WFA	
940	300	350	750	—	559	3RW4466-6BC34	73ZT3_BFA		73ZT3_DFA		73ZT3_OFA		73ZT3_EFA		73ZT3_WFA	
						200V	6		6		6		6		6	
						230V	2		2		2		2		2	
						380V	3		3		3		3		3	
						460V	4		4		4		4		4	
26	—	—	15	20	—	3RW4422-1BC35	73AT35BFA		73AT35DFA		73AT35OFA		73AT35EFA		73AT35WFA	
32	—	—	20	25	—	3RW4423-1BC35	73BT35BFA		73BT35DFA		73BT35OFA		73BT35EFA		73BT35WFA	
42	—	—	25	30	—	3RW4424-1BC35	73CT35BFA		73CT35DFA		73CT35OFA		73CT35EFA		73CT35WFA	
51	—	—	30	40	—	3RW4425-1BC35	73DT35BFA		73DT35DFA		73DT35OFA		73DT35EFA		73DT35WFA	
68	—	—	50	50	—	3RW4426-1BC35	73ET35BFA		73ET35DFA		73ET35OFA		73ET35EFA		73ET35WFA	
82	—	—	60	75	—	3RW4427-1BC35	73FT35BFA		73FT35DFA		73FT35OFA		73FT35EFA		73FT35WFA	
97	—	—	60	75	—	3RW4434-6BC35	73GT35BFA		73GT35DFA		73GT35OFA		73GT35EFA		73GT35WFA	
113	—	—	75	100	—	3RW4435-6BC35	73HT35BFA		73HT35DFA		73HT35OFA		73HT35EFA		73HT35WFA	
134	—	—	75	125	—	3RW4436-6BC35	73JT35BFA		73JT35DFA		73JT35OFA		73JT35EFA		73JT35WFA	
175	—	—	100	150	—	3RW4443-6BC35	73KT35BFA		73KT35DFA		73KT35OFA		73KT35EFA		73KT35WFA	
195	—	—	125	200	—	3RW4444-6BC35	73LT35BFA		73LT35DFA		73LT35OFA		73LT35EFA		73LT35WFA	
243	—	—	150	200	—	3RW4445-6BC35	73MT35BFA		73MT35DFA		73MT35OFA		73MT35EFA		73MT35WFA	
263	—	—	200	250	—	3RW4446-6BC35	73NT35BFA		73NT35DFA		73NT35OFA		73NT35EFA		73NT35WFA	
326	—	—	250	300	—	3RW4447-6BC35	73PT35BFA		73PT35DFA		73PT35OFA		73PT35EFA		73PT35WFA	
494	—	—	400	500	—	3RW4453-6BC35	73QT35BFA		73QT35DFA		73QT35OFA		73QT35EFA		73QT35WFA	
551	—	—	450	550	—	3RW4454-6BC35	73RT35BFA		73RT35DFA		73RT35OFA		73RT35EFA		73RT35WFA	
615	—	—	500	600	—	3RW4455-6BC35	73ST35BFA		73ST35DFA		73ST35OFA		73ST35EFA		73ST35WFA	
693	—	—	500	650	—	3RW4456-6BC35	73TT35BFA		73TT35DFA		73TT35OFA		73TT35EFA		73TT35WFA	
780	—	—	550	700	—	3RW4457-6BC35	73WT35BFA		73WT35DFA		73WT35OFA		73WT35EFA		73WT35WFA	
880	—	—	700	850	—	3RW4465-6BC35	73YT35BFA		73YT35DFA		73YT35OFA		73YT35EFA		73YT35WFA	
940	—	—	750	900	—	3RW4466-6BC35	73ZT35BFA		73ZT35DFA		73ZT35OFA		73ZT35EFA		73ZT35WFA	

Ⓐ Starter size is dependent on the nameplate Full Load Amps (FLA) rating of the motor. HPs are for reference only. Enclosed ratings are at 40°C.

Ⓑ Starter selection is dependent on type of application. Im = FLA rating of motor.

Enclosed 3RW44



3RW44 Enclosed features:

- Available in NEMA 1, 12, 3R, 4, and 4 stainless steel
- Compact size
- Built-in bypass contactor
- Multiple starting/stopping techniques including torque control
- Internal overload class 5, 10, 15, 20, or 30
- Built-in graphical LCD keypad
- Internal self protection
- Fault monitoring
- 3 parameter sets
- Communication capable via opt. Profibus module
- Programmable inputs and outputs
- External keypad available

Ordering Information

- ▶ Enclosed devices should be ordered by the FLA of the motor.
  - ▶ The 3RW44 is designed for normal starting applications.
  - ▶ For factory modifications see page 7/124.
  - ▶ For dimensional drawings see page 7/125.
  - ▶ For stocked versions see page 7/89.
- Class 74 non-combination starters include:
- NEMA rated enclosure
  - 3RW44 Sirius softstarter with built-in OL and bypass
  - Circuit breaker with disconnect
  - Control circuit transformer
  - Reset button

Ideal applications for 3RW44 enclosed softstarters:

- Fans
- Pumps
- Conveying systems and lifts
- Hydraulics
- Machine tools
- Mills saws
- Crushers and grinders
- Mixers
- HVAC systems

The 3RW44 severe duty rating table should be applied for high inertia applications such rock crushers, chippers, screw compressors, ect.

Class 74 starters are built to UL and CSA standards.

3RW44 For High Feature Applications

Enclosed Combination with Circuit Breaker Disconnect

Rated Operating Current	MAX HP <sup>①</sup>				KW 380V	Class 10 Light Duty (350% * Im for 10s) <sup>②</sup>									
	200V	230V	460V	575V		OPEN Style (Starter Only)	NEMA 1	List Price \$	NEMA 3R	List Price \$	NEMA 12	List Price \$	NEMA 4	List Price \$	NEMA 4/4X Stainless Steel
26	7.5	7.5	15	—	12	3RW4422-1BC34	74AT3_BFAP	—	74AT3_DFAP	—	74AT3_OFAP	74AT3_EFAP	—	74AT3_WFAP	—
32	10	10	20	—	15	3RW4423-1BC34	74BT3_BFAP	—	74BT3_DFAP	—	74BT3_OFAP	74BT3_EFAP	—	74BT3_WFAP	—
42	10	15	25	—	19	3RW4424-1BC34	74CT3_BFAP	—	74CT3_DFAP	—	74CT3_OFAP	74CT3_EFAP	—	74CT3_WFAP	—
51	15	15	30	—	22	3RW4425-1BC34	74DT3_BFAP	—	74DT3_DFAP	—	74DT3_OFAP	74DT3_EFAP	—	74DT3_WFAP	—
68	20	25	50	—	37	3RW4426-1BC34	74ET3_BFAP	—	74ET3_DFAP	—	74ET3_OFAP	74ET3_EFAP	—	74ET3_WFAP	—
82	25	30	60	—	45	3RW4427-1BC34	74FT3_BFAP	—	74FT3_DFAP	—	74FT3_OFAP	74FT3_EFAP	—	74FT3_WFAP	—
100	30	30	75	—	56	3RW4434-6BC34	74GT3_BFAP	—	74GT3_DFAP	—	74GT3_OFAP	74GT3_EFAP	—	74GT3_WFAP	—
117	30	40	75	—	56	3RW4435-6BC34	74HT3_BFAP	—	74HT3_DFAP	—	74HT3_OFAP	74HT3_EFAP	—	74HT3_WFAP	—
145	40	50	100	—	75	3RW4436-6BC34	74JT3_BFAP	—	74JT3_DFAP	—	74JT3_OFAP	74JT3_EFAP	—	74JT3_WFAP	—
180	60	60	125	—	93	3RW4443-6BC34	74KT3_BFAP	—	74KT3_DFAP	—	74KT3_OFAP	74KT3_EFAP	—	74KT3_WFAP	—
215	60	75	150	—	112	3RW4444-6BC34	74LT3_BFAP	—	74LT3_DFAP	—	74LT3_OFAP	74LT3_EFAP	—	74LT3_WFAP	—
280	75	100	200	—	149	3RW4445-6BC34	74MT3_BFAP	—	74MT3_DFAP	—	74MT3_OFAP	74MT3_EFAP	—	74MT3_WFAP	—
315	100	125	250	—	186	3RW4446-6BC34	74NT3_BFAP	—	74NT3_DFAP	—	74NT3_OFAP	74NT3_EFAP	—	74NT3_WFAP	—
385	125	150	300	—	224	3RW4447-6BC34	74PT3_BFAP	—	74PT3_DFAP	—	74PT3_OFAP	74PT3_EFAP	—	74PT3_WFAP	—
494	150	200	400	—	298	3RW4453-6BC34	74QT3_BFAT	—	74QT3_DFAT	—	74QT3_OFAT	74QT3_EFAT	—	74QT3_WFAT	—
551	150	200	450	—	336	3RW4454-6BC34	74RT3_BFAT	—	74RT3_DFAT	—	74RT3_OFAT	74RT3_EFAT	—	74RT3_WFAT	—
615	200	250	500	—	373	3RW4455-6BC34	74ST3_BFAT	—	74ST3_DFAT	—	74ST3_OFAT	74ST3_EFAT	—	74ST3_WFAT	—
693	200	250	550	—	410	3RW4456-6BC34	74TT3_BFAT	—	74TT3_DFAT	—	74TT3_OFAT	74TT3_EFAT	—	74TT3_WFAT	—
780	200	250	600	—	447	3RW4457-6BC34	74WT3_BFAT	—	74WT3_DFAT	—	74WT3_OFAT	74WT3_EFAT	—	74WT3_WFAT	—
970	350	350	800	—	597	3RW4465-6BC34	74YT3_BFAT	—	74YT3_DFAT	—	74YT3_OFAT	74YT3_EFAT	—	74YT3_WFAT	—
1076	350	400	900	—	672	3RW4466-6BC34	74ZT3_BFAT	—	74ZT3_DFAT	—	74ZT3_OFAT	74ZT3_EFAT	—	74ZT3_WFAT	—
						200V	6		6		6	6		6	
						230V	2		2		2	2		2	
						380V	3		3		3	3		3	
						460V	4		4		4	4		4	
26	—	—	15	20	—	3RW4422-1BC35	74AT35BFAP	—	74AT35DFAP	—	74AT35OFAP	74AT35EFAP	—	74AT35WFAP	—
32	—	—	20	25	—	3RW4423-1BC35	74BT35BFAP	—	74BT35DFAP	—	74BT35OFAP	74BT35EFAP	—	74BT35WFAP	—
42	—	—	25	30	—	3RW4424-1BC35	74CT35BFAP	—	74CT35DFAP	—	74CT35OFAP	74CT35EFAP	—	74CT35WFAP	—
51	—	—	30	40	—	3RW4425-1BC35	74DT35BFAP	—	74DT35DFAP	—	74DT35OFAP	74DT35EFAP	—	74DT35WFAP	—
68	—	—	50	50	—	3RW4426-1BC35	74ET35BFAP	—	74ET35DFAP	—	74ET35OFAP	74ET35EFAP	—	74ET35WFAP	—
82	—	—	60	75	—	3RW4427-1BC35	74FT35BFAP	—	74FT35DFAP	—	74FT35OFAP	74FT35EFAP	—	74FT35WFAP	—
100	—	—	75	75	—	3RW4434-6BC35	74GT35BFAP	—	74GT35DFAP	—	74GT35OFAP	74GT35EFAP	—	74GT35WFAP	—
117	—	—	75	100	—	3RW4435-6BC35	74HT35BFAP	—	74HT35DFAP	—	74HT35OFAP	74HT35EFAP	—	74HT35WFAP	—
145	—	—	100	125	—	3RW4436-6BC35	74JT35BFAP	—	74JT35DFAP	—	74JT35OFAP	74JT35EFAP	—	74JT35WFAP	—
180	—	—	125	150	—	3RW4443-6BC35	74KT35BFAP	—	74KT35DFAP	—	74KT35OFAP	74KT35EFAP	—	74KT35WFAP	—
215	—	—	150	200	—	3RW4444-6BC35	74LT35BFAP	—	74LT35DFAP	—	74LT35OFAP	74LT35EFAP	—	74LT35WFAP	—
280	—	—	200	250	—	3RW4445-6BC35	74MT35BFAP	—	74MT35DFAP	—	74MT35OFAP	74MT35EFAP	—	74MT35WFAP	—
315	—	—	250	300	—	3RW4446-6BC35	74NT35BFAP	—	74NT35DFAP	—	74NT35OFAP	74NT35EFAP	—	74NT35WFAP	—
385	—	—	300	400	—	3RW4447-6BC35	74PT35BFAP	—	74PT35DFAP	—	74PT35OFAP	74PT35EFAP	—	74PT35WFAP	—
494	—	—	400	500	—	3RW4453-6BC35	74QT35BFAT	—	74QT35DFAT	—	74QT35OFAT	74QT35EFAT	—	74QT35WFAT	—
551	—	—	450	600	—	3RW4454-6BC35	74RT35BFAT	—	74RT35DFAT	—	74RT35OFAT	74RT35EFAT	—	74RT35WFAT	—
615	—	—	500	700	—	3RW4455-6BC35	74ST35BFAT	—	74ST35DFAT	—	74ST35OFAT	74ST35EFAT	—	74ST35WFAT	—
693	—	—	550	750	—	3RW4456-6BC35	74TT35BFAT	—	74TT35DFAT	—	74TT35OFAT	74TT35EFAT	—	74TT35WFAT	—
780	—	—	600	850	—	3RW4457-6BC35	74WT35BFAT	—	74WT35DFAT	—	74WT35OFAT	74WT35EFAT	—	74WT35WFAT	—
970	—	—	800	1000	—	3RW4465-6BC35	74YT35BFAT	—	74YT35DFAT	—	74YT35OFAT	74YT35EFAT	—	74YT35WFAT	—
1076	—	—	900	1100	—	3RW4466-6BC35	74ZT35BFAT	—	74ZT35DFAT	—	74ZT35OFAT	74ZT35EFAT	—	74ZT35WFAT	—

① Starter size is dependent on the nameplate Full Load Amps (FLA) rating of the motor. HPs are for reference only. Enclosed ratings are at 40°C.

② Starter selection is dependent on type of application. Im = FLA rating of motor.



Enclosed 3RW44



- 3RW44 Enclosed features:
- Available in NEMA 1, 12, 3R, 4, and 4 stainless steel
  - Compact size
  - Built-in bypass contactor
  - Multiple starting/stopping techniques including torque control
  - Internal overload class 5, 10, 15, 20, or 30
  - Built-in graphical LCD keypad
  - Internal self protection
  - Fault monitoring
  - 3 parameter sets
  - Communication capable via opt. Profibus module
  - Programmable inputs and outputs
  - External keypad available

Ordering Information

- Enclosed devices should be ordered by the FLA of the motor.
  - The 3RW44 is designed for normal starting applications.
  - For factory modifications see page 7/124.
  - For dimensional drawings see page 7/125.
  - For stocked versions see page 7/89.
- Class 74 non-combination starters include:
- NEMA rated enclosure
  - 3RW44 Sirius softstarter with built-in OL and bypass
  - Circuit breaker with disconnect
  - Control circuit transformer
  - Reset button

Ideal applications for 3RW44 enclosed softstarters:

- Fans
- Pumps
- Conveying systems and lifts
- Hydraulics
- Machine tools
- Mills saws
- Crushers and grinders
- Mixers
- HVAC systems

The 3RW44 severe duty rating table should be applied for high inertia applications such rock crushers, chippers, screw compressors, ect.

Class 74 starters are built to UL and CSA standards.

3RW44 For High Feature Applications

Enclosed Combination with Circuit Breaker Disconnect

Rated Operating Current	MAX HP <sup>①</sup>				KW	Class 20 Severe Duty (350% * Im for 20s) <sup>②</sup>										
	200V	230V	460V	575V		380V	OPEN Style (Starter Only)	NEMA 1	List Price \$	NEMA 3R	List Price \$	NEMA 12	List Price \$	NEMA 4	List Price \$	NEMA 4/4X Stainless Steel
26	7.5	7.5	15	—	12	3RW4422-1BC34	74AT3_BFAP		74AT3_DFAP		74AT3_OFAP		74AT3_EFAP		74AT3_WFAP	
32	10	10	20	—	15	3RW4423-1BC34	74BT3_BFAP		74BT3_DFAP		74BT3_OFAP		74BT3_EFAP		74BT3_WFAP	
42	10	15	25	—	19	3RW4424-1BC34	74CT3_BFAP		74CT3_DFAP		74CT3_OFAP		74CT3_EFAP		74CT3_WFAP	
51	15	15	30	—	22	3RW4425-1BC34	74DT3_BFAP		74DT3_DFAP		74DT3_OFAP		74DT3_EFAP		74DT3_WFAP	
68	20	25	50	—	37	3RW4426-1BC34	74ET3_BFAP		74ET3_DFAP		74ET3_OFAP		74ET3_EFAP		74ET3_WFAP	
82	25	30	60	—	45	3RW4427-1BC34	74FT3_BFAP		74FT3_DFAP		74FT3_OFAP		74FT3_EFAP		74FT3_WFAP	
97	30	30	60	—	45	3RW4434-6BC34	74GT3_BFAP		74GT3_DFAP		74GT3_OFAP		74GT3_EFAP		74GT3_WFAP	
113	30	40	75	—	56	3RW4435-6BC34	74HT3_BFAP		74HT3_DFAP		74HT3_OFAP		74HT3_EFAP		74HT3_WFAP	
134	40	50	75	—	56	3RW4436-6BC34	74JT3_BFAP		74JT3_DFAP		74JT3_OFAP		74JT3_EFAP		74JT3_WFAP	
175	50	60	100	—	75	3RW4443-6BC34	74KT3_BFAP		74KT3_DFAP		74KT3_OFAP		74KT3_EFAP		74KT3_WFAP	
195	60	75	125	—	93	3RW4444-6BC34	74LT3_BFAP		74LT3_DFAP		74LT3_OFAP		74LT3_EFAP		74LT3_WFAP	
243	75	75	150	—	112	3RW4445-6BC34	74MT3_BFAP		74MT3_DFAP		74MT3_OFAP		74MT3_EFAP		74MT3_WFAP	
263	75	100	200	—	149	3RW4446-6BC34	74NT3_BFAP		74NT3_DFAP		74NT3_OFAP		74NT3_EFAP		74NT3_WFAP	
326	100	125	250	—	186	3RW4447-6BC34	74PT3_BFAP		74PT3_DFAP		74PT3_OFAP		74PT3_EFAP		74PT3_WFAP	
494	150	150	400	—	224	3RW4453-6BC34	74QT3_BFAT		74QT3_DFAT		74QT3_OFAT		74QT3_EFAT		74QT3_WFAT	
551	150	200	450	—	298	3RW4454-6BC34	74RT3_BFAT		74RT3_DFAT		74RT3_OFAT		74RT3_EFAT		74RT3_WFAT	
615	200	200	500	—	336	3RW4455-6BC34	74ST3_BFAT		74ST3_DFAT		74ST3_OFAT		74ST3_EFAT		74ST3_WFAT	
634	200	250	500	—	373	3RW4456-6BC34	74TT3_BFAT		74TT3_DFAT		74TT3_OFAT		74TT3_EFAT		74TT3_WFAT	
650	200	250	550	—	410	3RW4457-6BC34	74WT3_BFAT		74WT3_DFAT		74WT3_OFAT		74WT3_EFAT		74WT3_WFAT	
880	300	350	700	—	522	3RW4465-6BC34	74YT3_BFAT		74YT3_DFAT		74YT3_OFAT		74YT3_EFAT		74YT3_WFAT	
940	300	350	750	—	559	3RW4466-6BC34	74ZT3_BFAT		74ZT3_DFAT		74ZT3_OFAT		74ZT3_EFAT		74ZT3_WFAT	
							200V	6		6		6		6		6
							230V	2		2		2		2		2
							380V	3		3		3		3		3
							460V	4		4		4		4		4
26	—	—	15	20	—	3RW4422-1BC35	74AT35BFAP		74AT35DFAP		74AT35OFAP		74AT35EFAP		74AT35WFAP	
32	—	—	20	25	—	3RW4423-1BC35	74BT35BFAP		74BT35DFAP		74BT35OFAP		74BT35EFAP		74BT35WFAP	
42	—	—	25	30	—	3RW4424-1BC35	74CT35BFAP		74CT35DFAP		74CT35OFAP		74CT35EFAP		74CT35WFAP	
51	—	—	30	40	—	3RW4425-1BC35	74DT35BFAP		74DT35DFAP		74DT35OFAP		74DT35EFAP		74DT35WFAP	
68	—	—	50	50	—	3RW4426-1BC35	74ET35BFAP		74ET35DFAP		74ET35OFAP		74ET35EFAP		74ET35WFAP	
82	—	—	60	75	—	3RW4427-1BC35	74FT35BFAP		74FT35DFAP		74FT35OFAP		74FT35EFAP		74FT35WFAP	
97	—	—	60	75	—	3RW4434-6BC35	74GT35BFAP		74GT35DFAP		74GT35OFAP		74GT35EFAP		74GT35WFAP	
113	—	—	75	100	—	3RW4435-6BC35	74HT35BFAP		74HT35DFAP		74HT35OFAP		74HT35EFAP		74HT35WFAP	
134	—	—	75	125	—	3RW4436-6BC35	74JT35BFAP		74JT35DFAP		74JT35OFAP		74JT35EFAP		74JT35WFAP	
175	—	—	100	150	—	3RW4443-6BC35	74KT35BFAP		74KT35DFAP		74KT35OFAP		74KT35EFAP		74KT35WFAP	
195	—	—	125	200	—	3RW4444-6BC35	74LT35BFAP		74LT35DFAP		74LT35OFAP		74LT35EFAP		74LT35WFAP	
243	—	—	150	200	—	3RW4445-6BC35	74MT35BFAP		74MT35DFAP		74MT35OFAP		74MT35EFAP		74MT35WFAP	
263	—	—	200	250	—	3RW4446-6BC35	74NT35BFAP		74NT35DFAP		74NT35OFAP		74NT35EFAP		74NT35WFAP	
326	—	—	250	300	—	3RW4447-6BC35	74PT35BFAP		74PT35DFAP		74PT35OFAP		74PT35EFAP		74PT35WFAP	
494	—	—	400	500	—	3RW4453-6BC35	74QT35BFAT		74QT35DFAT		74QT35OFAT		74QT35EFAT		74QT35WFAT	
551	—	—	450	550	—	3RW4454-6BC35	74RT35BFAT		74RT35DFAT		74RT35OFAT		74RT35EFAT		74RT35WFAT	
615	—	—	500	600	—	3RW4455-6BC35	74ST35BFAT		74ST35DFAT		74ST35OFAT		74ST35EFAT		74ST35WFAT	
693	—	—	500	650	—	3RW4456-6BC35	74TT35BFAT		74TT35DFAT		74TT35OFAT		74TT35EFAT		74TT35WFAT	
780	—	—	550	700	—	3RW4457-6BC35	74WT35BFAT		74WT35DFAT		74WT35OFAT		74WT35EFAT		74WT35WFAT	
880	—	—	700	850	—	3RW4465-6BC35	74YT35BFAT		74YT35DFAT		74YT35OFAT		74YT35EFAT		74YT35WFAT	
940	—	—	750	900	—	3RW4466-6BC35	74ZT35BFAT		74ZT35DFAT		74ZT35OFAT		74ZT35EFAT		74ZT35WFAT	

① Starter size is dependent on the nameplate Full Load Amps (FLA) rating of the motor. HPs are for reference only. Enclosed ratings are at 40°C.

② Starter selection is dependent on type of application. Im = FLA rating of motor.

Enclosed 3RW44



3RW44 Enclosed features:

- Available in NEMA 1, 12, 3R, 4, and 4 stainless steel
- Compact size
- Built-in bypass contactor
- Multiple starting/stopping techniques including torque control
- Internal overload class 5, 10, 15, 20, or 30
- Built-in graphical LCD keypad
- Internal self protection
- Fault monitoring
- 3 parameter sets
- Communication capable via opt. Profibus module
- Programmable inputs and outputs
- External keypad available

Ordering Information

- ▶ Enclosed devices should be ordered by the FLA of the motor.
  - ▶ The 3RW44 is designed for normal starting applications.
  - ▶ For factory modifications see page 7/124.
  - ▶ For dimensional drawings see page 7/125.
- Class 74 non-combination starters include:
- NEMA rated enclosure
  - 3RW44 Sirius softstarter with built-in OL and bypass
  - Fusible disconnect
  - Control circuit transformer
  - Reset button

Ideal applications for 3RW44 enclosed softstarters:

- Fans
- Pumps
- Conveying systems and lifts
- Hydraulics
- Machine tools
- Mills saws
- Crushers and grinders
- Mixers
- HVAC systems

The 3RW44 severe duty rating table should be applied for high inertia applications such rock crushers, chippers, screw compressors, ect.

Class 74 starters are built to UL and CSA standards.

For all technical information, please consult the 2006 Industrial Controls Catalog or contact your local sales support center.

3RW44 For High Feature Applications  
Enclosed Combination with Fusible Disconnect

Rated Operating Current	MAX HP <sup>Ⓛ</sup>				KW 380V	Class 10 Light Duty <sup>Ⓛ</sup> (350% * Im for 10s)									
	200V	230V	460V	575V		OPEN Style (Starter Only)	NEMA 1	List Price \$	NEMA 3R	List Price \$	NEMA 12	List Price \$	NEMA 4	List Price \$	NEMA 4/4X Stainless Steel
26	7.5	7.5	15	—	12	3RW4422-1BC34	74AT3_BFAF		74AT3_DFAF		74AT3_OFAF		74AT3_EFAF		74AT3_WFAF
32	10	10	20	—	15	3RW4423-1BC34	74BT3_BFAF		74BT3_DFAF		74BT3_OFAF		74BT3_EFAF		74BT3_WFAF
42	10	15	25	—	19	3RW4424-1BC34	74CT3_BFAF		74CT3_DFAF		74CT3_OFAF		74CT3_EFAF		74CT3_WFAF
51	15	15	30	—	22	3RW4425-1BC34	74DT3_BFAF		74DT3_DFAF		74DT3_OFAF		74DT3_EFAF		74DT3_WFAF
68	20	25	50	—	37	3RW4426-1BC34	74ET3_BFAF		74ET3_DFAF		74ET3_OFAF		74ET3_EFAF		74ET3_WFAF
82	25	30	60	—	45	3RW4427-1BC34	74FT3_BFAF		74FT3_DFAF		74FT3_OFAF		74FT3_EFAF		74FT3_WFAF
100	30	30	75	—	56	3RW4434-6BC34	74GT3_BFAF		74GT3_DFAF		74GT3_OFAF		74GT3_EFAF		74GT3_WFAF
117	30	40	75	—	56	3RW4435-6BC34	74HT3_BFAF		74HT3_DFAF		74HT3_OFAF		74HT3_EFAF		74HT3_WFAF
145	40	50	100	—	75	3RW4436-6BC34	74JT3_BFAF		74JT3_DFAF		74JT3_OFAF		74JT3_EFAF		74JT3_WFAF
180	60	60	125	—	93	3RW4443-6BC34	74KT3_BFAF		74KT3_DFAF		74KT3_OFAF		74KT3_EFAF		74KT3_WFAF
215	60	75	150	—	112	3RW4444-6BC34	74LT3_BFAF		74LT3_DFAF		74LT3_OFAF		74LT3_EFAF		74LT3_WFAF
280	75	100	200	—	149	3RW4445-6BC34	74MT3_BFAF		74MT3_DFAF		74MT3_OFAF		74MT3_EFAF		74MT3_WFAF
315	100	125	250	—	186	3RW4446-6BC34	74NT3_BFAF		74NT3_DFAF		74NT3_OFAF		74NT3_EFAF		74NT3_WFAF
385	125	150	300	—	224	3RW4447-6BC34	74PT3_BFAF		74PT3_DFAF		74PT3_OFAF		74PT3_EFAF		74PT3_WFAF
494	150	200	400	—	298	3RW4453-6BC34	74QT3_BFAF				74QT3_OFAF				
551	150	200	450	—	336	3RW4454-6BC34	74RT3_BFAF				74RT3_OFAF				
615	200	250	500	—	373	3RW4455-6BC34	74ST3_BFAF				74ST3_OFAF				
693	200	250	550	—		3RW4456-6BC34	74TT3_BFAF				74TT3_OFAF				
780	200	250	600	—	447	3RW4457-6BC34	74WT3_BFAF				74WT3_OFAF				
						200V	6		6		6		6		6
						230V	2		2		2		2		2
						380V	3		3		3		3		3
						460V	4		4		4		4		4
26	—	—	15	20	—	3RW4422-1BC35	74AT35BFAF		74AT35DFAF		74AT350FAF		74AT35EFAF		74AT35WFAF
32	—	—	20	25	—	3RW4423-1BC35	74BT35BFAF		74BT35DFAF		74BT350FAF		74BT35EFAF		74BT35WFAF
42	—	—	25	30	—	3RW4424-1BC35	74CT35BFAF		74CT35DFAF		74CT350FAF		74CT35EFAF		74CT35WFAF
51	—	—	30	40	—	3RW4425-1BC35	74DT35BFAF		74DT35DFAF		74DT350FAF		74DT35EFAF		74DT35WFAF
68	—	—	50	50	—	3RW4426-1BC35	74ET35BFAF		74ET35DFAF		74ET350FAF		74ET35EFAF		74ET35WFAF
82	—	—	60	75	—	3RW4427-1BC35	74FT35BFAF		74FT35DFAF		74FT350FAF		74FT35EFAF		74FT35WFAF
100	—	—	75	75	—	3RW4434-6BC35	74GT35BFAF		74GT35DFAF		74GT350FAF		74GT35EFAF		74GT35WFAF
117	—	—	75	100	—	3RW4435-6BC35	74HT35BFAF		74HT35DFAF		74HT350FAF		74HT35EFAF		74HT35WFAF
145	—	—	100	125	—	3RW4436-6BC35	74JT35BFAF		74JT35DFAF		74JT350FAF		74JT35EFAF		74JT35WFAF
180	—	—	125	150	—	3RW4443-6BC35	74KT35BFAF		74KT35DFAF		74KT350FAF		74KT35EFAF		74KT35WFAF
215	—	—	150	200	—	3RW4444-6BC35	74LT35BFAF		74LT35DFAF		74LT350FAF		74LT35EFAF		74LT35WFAF
280	—	—	200	250	—	3RW4445-6BC35	74MT35BFAF		74MT35DFAF		74MT350FAF		74MT35EFAF		74MT35WFAF
315	—	—	250	300	—	3RW4446-6BC35	74NT35BFAF		74NT35DFAF		74NT350FAF		74NT35EFAF		74NT35WFAF
385	—	—	300	400	—	3RW4447-6BC35	74PT35BFAF		74PT35DFAF		74PT350FAF		74PT35EFAF		74PT35WFAF
494	—	—	400	500	—	3RW4453-6BC35	74QT35BFAF				74QT350FAF				
551	—	—	450	600	—	3RW4454-6BC35	74RT35BFAF				74RT350FAF				
615	—	—	500	700	—	3RW4455-6BC35	74ST35BFAF				74ST350FAF				
693	—	—	550	750	—	3RW4456-6BC35	74TT35BFAF				74TT350FAF				
780	—	—	600	850	—	3RW4457-6BC35	74WT35BFAF				74WT350FAF				

Ⓛ Starter size is dependent on the nameplate Full Load Amps (FLA) rating of the motor. HPs are for reference only. Enclosed ratings are at 40°C.

Ⓛ Starter selection is dependent on type of application. Im = FLA rating of motor.

Enclosed 3RW44



3RW44 Enclosed features:

- Available in NEMA 1, 12, 3R, 4, and 4 stainless steel
- Compact size
- Built-in bypass contactor
- Multiple starting/stopping techniques including torque control
- Internal overload class 5, 10, 15, 20, or 30
- Built-in graphical LCD keypad
- Internal self protection
- Fault monitoring
- 3 parameter sets
- Communication capable via opt. Profibus module
- Programmable inputs and outputs
- External keypad available

Ordering Information

- ▶ Enclosed devices should be ordered by the FLA of the motor.
- ▶ The 3RW44 is designed for normal starting applications.
- ▶ For factory modifications see page 7/124.
- ▶ For dimensional drawings see page 7/125.

Class 74 non-combination starters include:

- NEMA rated enclosure
- 3RW44 Sirius softstarter with built-in OL and bypass
- Fusible disconnect
- Control circuit transformer
- Reset button

Ideal applications for 3RW44 enclosed softstarters:

- Fans
- Pumps
- Conveying systems and lifts
- Hydraulics
- Machine tools
- Mills saws
- Crushers and grinders
- Mixers
- HVAC systems

The 3RW44 severe duty rating table should be applied for high inertia applications such rock crushers, chippers, screw compressors, ect.

Class 74 starters are built to UL and CSA standards.

For all technical information, please consult the 2006 Industrial Controls Catalog or contact your local sales support center.

3RW44 For High Feature Applications  
Enclosed Combination with Fusible Disconnect

Rated Operating Current	MAX HP <sup>Ⓛ</sup>				KW	Class 20 Severe Duty (350% * Im for 20s) <sup>Ⓜ</sup>									
	200V	230V	460V	575V		380V	OPEN Style (Starter Only)		List Price \$	List Price \$		List Price \$	List Price \$	NEMA 4/4X Stainless Steel	List Price \$
	200V	230V	460V	575V		380V	NEMA 1	NEMA 3R	NEMA 12	NEMA 4	NEMA 12	NEMA 4	NEMA 4/4X Stainless Steel		
26	7.5	7.5	15	—	12	3RW4422-1BC34	74AT3_BFAF	74AT3_DFAF	74AT3_OFAF	74AT3_EFAF	74AT3_WFAF				
32	10	10	20	—	15	3RW4423-1BC34	74BT3_BFAF	74BT3_DFAF	74BT3_OFAF	74BT3_EFAF	74BT3_WFAF				
42	10	15	25	—	19	3RW4424-1BC34	74CT3_BFAF	74CT3_DFAF	74CT3_OFAF	74CT3_EFAF	74CT3_WFAF				
51	15	15	30	—	22	3RW4425-1BC34	74DT3_BFAF	74DT3_DFAF	74DT3_OFAF	74DT3_EFAF	74DT3_WFAF				
68	20	25	50	—	37	3RW4426-1BC34	74ET3_BFAF	74ET3_DFAF	74ET3_OFAF	74ET3_EFAF	74ET3_WFAF				
82	25	30	60	—	45	3RW4427-1BC34	74FT3_BFAF	74FT3_DFAF	74FT3_OFAF	74FT3_EFAF	74FT3_WFAF				
97	30	30	60	—	45	3RW4434-6BC34	74GT3_BFAF	74GT3_DFAF	74GT3_OFAF	74GT3_EFAF	74GT3_WFAF				
113	30	40	75	—	56	3RW4435-6BC34	74HT3_BFAF	74HT3_DFAF	74HT3_OFAF	74HT3_EFAF	74HT3_WFAF				
134	40	50	75	—	56	3RW4436-6BC34	74JT3_BFAF	74JT3_DFAF	74JT3_OFAF	74JT3_EFAF	74JT3_WFAF				
175	50	60	100	—	75	3RW4443-6BC34	74KT3_BFAF	74KT3_DFAF	74KT3_OFAF	74KT3_EFAF	74KT3_WFAF				
195	60	75	125	—	93	3RW4444-6BC34	74LT3_BFAF	74LT3_DFAF	74LT3_OFAF	74LT3_EFAF	74LT3_WFAF				
243	75	75	150	—	112	3RW4445-6BC34	74MT3_BFAF	74MT3_DFAF	74MT3_OFAF	74MT3_EFAF	74MT3_WFAF				
263	75	100	200	—	149	3RW4446-6BC34	74NT3_BFAF	74NT3_DFAF	74NT3_OFAF	74NT3_EFAF	74NT3_WFAF				
326	100	125	250	—	186	3RW4447-6BC34	74PT3_BFAF	74PT3_DFAF	74PT3_OFAF	74PT3_EFAF	74PT3_WFAF				
494	150	150	400	—	298	3RW4453-6BC34	74QT3_BFAF	74QT3_DFAF	74QT3_OFAF	74QT3_EFAF	74QT3_WFAF				
551	150	200	450	—	336	3RW4454-6BC34	74RT3_BFAF	74RT3_DFAF	74RT3_OFAF	74RT3_EFAF	74RT3_WFAF				
615	200	200	500	—	373	3RW4455-6BC34	74ST3_BFAF	74ST3_DFAF	74ST3_OFAF	74ST3_EFAF	74ST3_WFAF				
634	200	250	500	—	373	3RW4456-6BC34	74TT3_BFAF	74TT3_DFAF	74TT3_OFAF	74TT3_EFAF	74TT3_WFAF				
650	200	250	550	—	373	3RW4457-6BC34	74WT3_BFAF	74WT3_DFAF	74WT3_OFAF	74WT3_EFAF	74WT3_WFAF				
						200V	6	6	6	6	6				
						230V	2	2	2	2	2				
						380V	3	3	3	3	3				
						460V	4	4	4	4	4				
26	—	—	15	20	—	3RW4422-1BC35	74AT35BFAF	74AT35DFAF	74AT35OFAF	74AT35EFAF	74AT35WFAF				
32	—	—	20	25	—	3RW4423-1BC35	74BT35BFAF	74BT35DFAF	74BT35OFAF	74BT35EFAF	74BT35WFAF				
42	—	—	25	30	—	3RW4424-1BC35	74CT35BFAF	74CT35DFAF	74CT35OFAF	74CT35EFAF	74CT35WFAF				
51	—	—	30	40	—	3RW4425-1BC35	74DT35BFAF	74DT35DFAF	74DT35OFAF	74DT35EFAF	74DT35WFAF				
68	—	—	50	50	—	3RW4426-1BC35	74ET35BFAF	74ET35DFAF	74ET35OFAF	74ET35EFAF	74ET35WFAF				
82	—	—	60	75	—	3RW4427-1BC35	74FT35BFAF	74FT35DFAF	74FT35OFAF	74FT35EFAF	74FT35WFAF				
97	—	—	60	75	—	3RW4434-6BC35	74GT35BFAF	74GT35DFAF	74GT35OFAF	74GT35EFAF	74GT35WFAF				
113	—	—	75	100	—	3RW4435-6BC35	74HT35BFAF	74HT35DFAF	74HT35OFAF	74HT35EFAF	74HT35WFAF				
134	—	—	75	125	—	3RW4436-6BC35	74JT35BFAF	74JT35DFAF	74JT35OFAF	74JT35EFAF	74JT35WFAF				
175	—	—	100	150	—	3RW4443-6BC35	74KT35BFAF	74KT35DFAF	74KT35OFAF	74KT35EFAF	74KT35WFAF				
195	—	—	125	200	—	3RW4444-6BC35	74LT35BFAF	74LT35DFAF	74LT35OFAF	74LT35EFAF	74LT35WFAF				
243	—	—	150	200	—	3RW4445-6BC35	74MT35BFAF	74MT35DFAF	74MT35OFAF	74MT35EFAF	74MT35WFAF				
263	—	—	200	250	—	3RW4446-6BC35	74NT35BFAF	74NT35DFAF	74NT35OFAF	74NT35EFAF	74NT35WFAF				
326	—	—	250	300	—	3RW4447-6BC35	74PT35BFAF	74PT35DFAF	74PT35OFAF	74PT35EFAF	74PT35WFAF				
494	—	—	400	500	—	3RW4453-6BC35	74QT35BFAF	74QT35DFAF	74QT35OFAF	74QT35EFAF	74QT35WFAF				
551	—	—	450	550	—	3RW4454-6BC35	74RT35BFAF	74RT35DFAF	74RT35OFAF	74RT35EFAF	74RT35WFAF				
615	—	—	500	600	—	3RW4455-6BC35	74ST35BFAF	74ST35DFAF	74ST35OFAF	74ST35EFAF	74ST35WFAF				
693	—	—	550	650	—	3RW4456-6BC35	74TT35BFAF	74TT35DFAF	74TT35OFAF	74TT35EFAF	74TT35WFAF				
780	—	—	600	700	—	3RW4457-6BC35	74WT35BFAF	74WT35DFAF	74WT35OFAF	74WT35EFAF	74WT35WFAF				

Ⓛ Starter size is dependent on the nameplate Full Load Amps (FLA) rating of the motor. HPs are for reference only. Enclosed ratings are at 40°C.

Ⓜ Starter selection is dependent on type of application. Im = FLA rating of motor.

## Factory Modifications

Modification Available modifications in STANDARD enclosure	3RW Version	Enclosed Style	Enclosure NEMA Type	Mod Suffix
<b>Push Buttons</b>				
Start/Stop	3RW40/44	73/74	ALL	A1
Emergency Stop	3RW40/44	73/74	ALL	ES
<b>Selector Switches</b>				
Hand-Off-Auto	3RW40/44	73/74	ALL	A3
Hand-Off-Auto w/ start pushbutton	3RW40/44	73/74	ALL	S3
Off-On	3RW40/44	73/74	ALL	A4
<b>Pilot Light</b>				
Red 'On'	3RW40/44	73/74	ALL	FA
Green 'On'	3RW40/44	73/74	ALL	FB
Red 'Run'	3RW40/44	73/74	ALL	FC
Green 'Run'	3RW40/44	73/74	ALL	FD
LED Bulb Upgrade <sup>②</sup>	3RW40/44	73/74	ALL	FE
Red 'Off'	3RW40/44	73/74	ALL	FJ
Green 'Off'	3RW40/44	73/74	ALL	FK
Amber 'Fault'	3RW40/44	73/74	ALL	FL
White 'Control Power On'	3RW40/44	73/74	ALL	FW
Red, 'On' Push-to-Test	3RW40/44	73/74	ALL	FS
Green 'On' Push-to-Test	3RW40/44	73/74	ALL	FT
Green 'Off' Push-to-Test	3RW40/44	73/74	ALL	FU
Custom pilot light (state color and nameplate text)	3RW40/44	73/74	ALL	FZ
<b>Through the Door Metering</b>				
External keypad for 3RW44	3RW44	73/74	1, 12	K1
Elapse time meter	3RW40/44	73/74	1, 12 (120V)	M5
<b>Control Options</b>				
Profibus Communication Module (installed-connection cable not supplied)	3RW44	73/74	ALL	P1
Profinet Communication Module (installed-connection cable not supplied)	3RW44	73/74	ALL	P2
Ground Lug - 1 Conductor	3RW40/44	73/74	ALL	L10
Alarm Package (horn, light, relay & push button)	3RW40/44	73/74	1, 3R, 12	M7
Electronic 8 function timing relay (.05s - 100h) 24V/100-127V supplied mounted and unwired	3RW40/44	73/74	ALL	TR
Control Relay supplied mounted and unwired (4 pole max)	3RW40/44	73/74	ALL	R04 R22 R40
Circuit Breaker Shunt Trip (included std in 3RW40 versions)	3RW44	74	ALL	L6
Function identification plate w/ marking as specified	3RW40/44	73/74	ALL	N1
Service Entrance Labeled	3RW40/44	74	ALL	N3
Terminal Block 3 point	3RW40/44	73/74	ALL	TC3
Terminal Block 6 point	3RW40/44	73/74	ALL	TC6
Terminal Block 9 point	3RW40/44	73/74	ALL	TC9
Terminal Block 12 point	3RW40/44	73/74	ALL	TC12

Emergency HP Rated Bypass Starter	3RW Version	Class	Enclosure NEMA Type	Mod Suffix
	3RW40 <sup>①②</sup>	73/74	1/12/3R/4	A12

Available Modifications Requiring the MODIFIED OPTIONS Box Size (to be used with the selections ending in GA*)	3RW Version	Class	Enclosure NEMA Type	Mod Suffix
Isolation Contactor <sup>③</sup>	3RW40/44	73/74	1/12/3R/4	IC
100 VA Extra CPT Capacity	3RW40/44	73/74	ALL	CA
Space Heater (120V separate control)	3RW40/44	73/74	ALL	SH
Space Heater w/ T-stat (120V separate control)	3RW40/44	73/74	ALL	ST
Lightning Arrestor	3RW40/44	73/74	ALL	L

① (A) For sizes 73YT & 73ZT, mods IC & A12 are available individually or together;  
 (B) For sizes 74YT & 74ZT (combination w/ CB), mods IC & A12 are only available individually (NOT together); (C) For sizes 74YT & 74ZT (combination w/ fusible disc), mods IC & A12 are NOT available individually or together.  
 ② An isolation contactor is included with the emergency HP rated bypass starter for version 3RW40 soft starters.

③ Isolation contactor IC is included as standard with version 3RW40 model R (4th character of the cat. no.) soft starters.  
 ④ Pilot lights are transformer type as standard. For LED type bulbs, order suffix FE in addition to the standard device suffix(es). For example, to order red "ON" and green "OFF" pilot lights with LED bulbs, order FA, FK and FE.

Class 73, 74

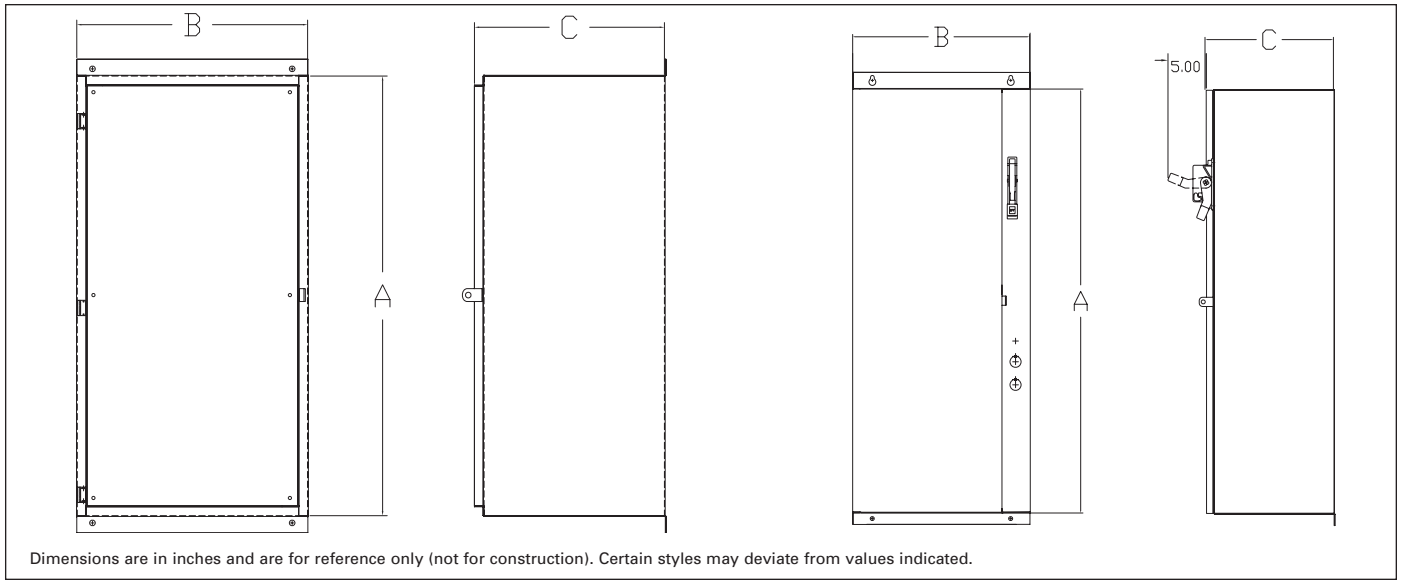

Non-Combination Class 73

N1, N3R, N12, N4 Standard Enclosure

	Amps	A	B	C
3RW40new	11 - 73	25	18	13
	98	36	23	10
3RW40	117-145	36	18	15
	205-315	36	22	20
	385	54	36	20
3RW44	26 - 68	26	12.5	15
	82 - 117	36	18	15
	145 - 215	36	22	20
	280 - 385	54	36	20
	494 - 780	90	40	20
	970 - 1076	90	50	20

N4X Stainless Steel Standard Enclosure

	Amps	A	B	C
3RW40new	11- 98	55	29	11
3RW40	117	36	18	15
	145 - 205A	36	22	20
	248 - 385	54	36	20
3RW44	26 - 51	26	12.5	15
	68 - 82	36	18	15
	100 - 117	36	22	20
	145 - 385	54	36	20

N1, N3R, N12, N4 Modified Enclosure

	Amps	A	B	C
3RW40	117-385	56	36	20
3RW44	26-51	36	22	20
	68-385	54	36	20

N4X Stainless Steel Modified Enclosure

	Amps	A	B	C
3RW40	117-385	54	36	20
3RW44	26-51	36	22	20
	68-385	54	36	20

Combination Type Class 74

N1, N3R, N12, N4 Standard Enclosure

	Amps	A	B	C
3RW40new	11 - 73	36	20	11
	98	46	20	10
3RW40	117	50	25	20
	145 - 205	66	25	20
	248 - 315	90	30	20
	385	90	40	20
3RW44	26 - 68	36	23	15
	82 - 117	50	25	20
	145 - 215	66	25	20
	280	90	30	20
	315 - 384	90	40	20
	494	90	40	20
	551 - 780	90	40 <sup>Ⓞ</sup>	20
	970 - 1076	90	50	20

N1, N12 Fusible

	Amps	A	B	C
3RW44	494-780	90	50	20

N4X Stainless Steel Standard Enclosure

	Amps	A	B	C
3RW40new	11- 98	55	29	11
3RW40	117 - 145	54	36	20
	205 - 300	90	40	20
3RW44	26 - 42	36	23	15
	51 - 100	50	25	20
	117 - 145	54	36	20
	180 - 385	90	40	20

N1, N3R, N12, N4 Modified Enclosure

	Amps	A	B	C
3RW40	117 - 248	76	30	20
	315	90	30	20
	385	90	40	20
3RW44	26 - 215	76	30	20
	280	90	30	20
	315 - 385	90	40	20

N4X Stainless Steel Modified Enclosure

	Amps	A	B	C
3RW40	117-145	76	30	20
3RW44	26-145	76	30	20

Ⓞ Add 4" for N4.

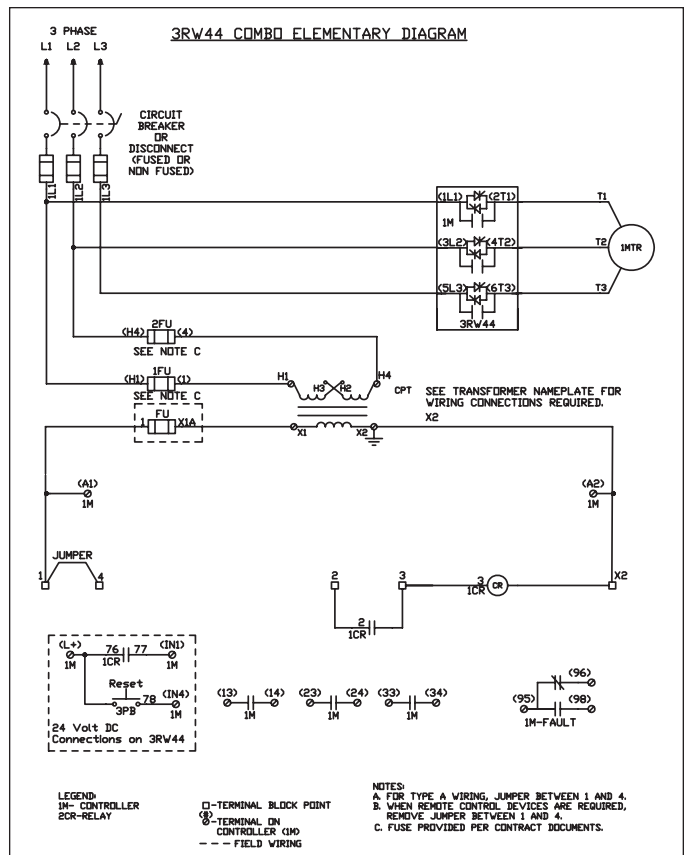
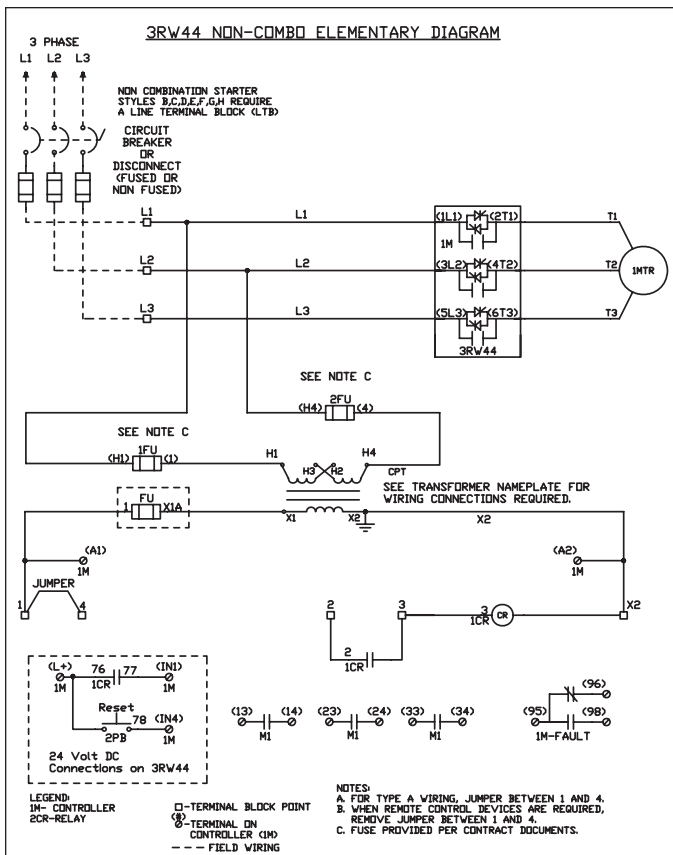
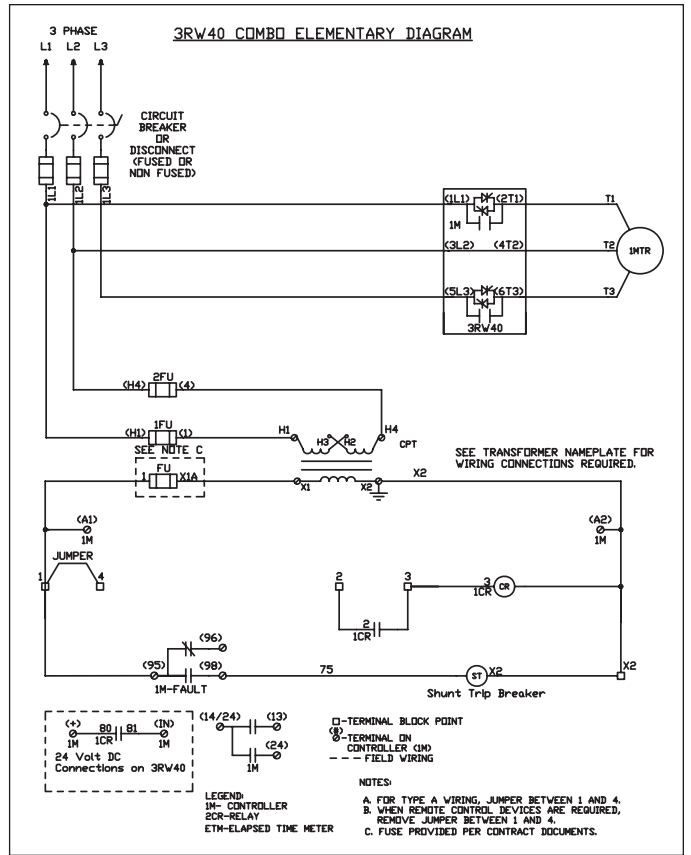
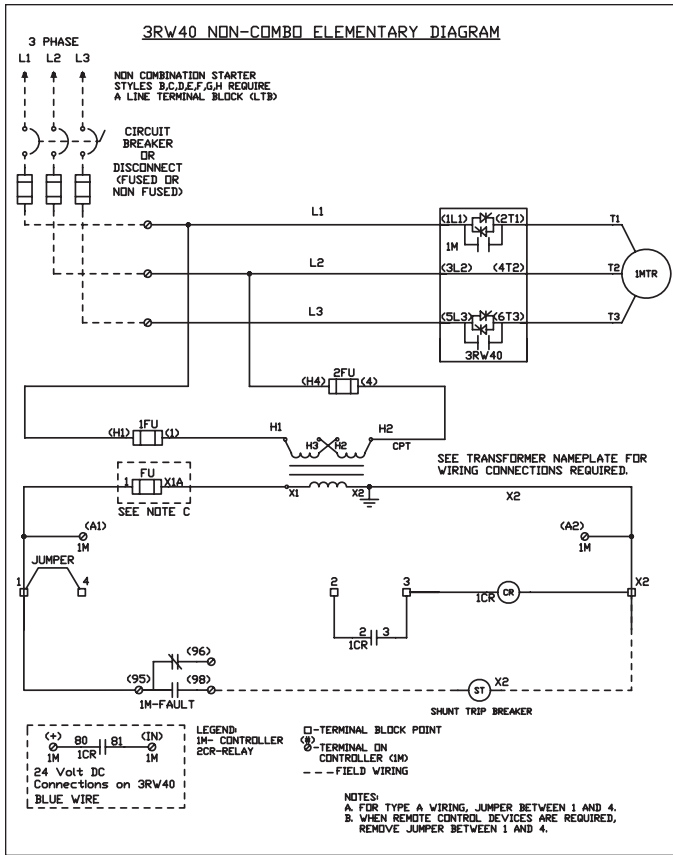

## SINAMICS G120X

### An infrastructure drive for pumps, fans and compressors

Siemens introduces an exciting new addition to the existing SINAMICS product portfolio—the G120X—an “infrastructure” drive up to 700 hp (630kW), which is targeted for pump, fan and compressor applications in the water/wastewater, HVAC, irrigation/agriculture and industrial chiller and refrigeration industries.

#### Seamless process for higher efficiency

SINAMICS G120X is simple, seamless, cost- and energy-efficient, robust, reliable and fit for digitalization. It integrates easily into existing applications, works with any standard motor (induction, synchronous and synchronous reluctance) and can be configured for cost-optimization and resource-saving operation which ultimately helps reduce total cost of ownership. SINAMICS G120X meets all the latest industry standards with regard to energy efficiency and product safety, and offers enhanced safety with SIL3-rated safety functions and up to 100kA short-circuit current rating according to new UL61800-5-1 design.



### Application functions

<b>Pump-specific</b>		
<ul style="list-style-type: none"> <li>■ Deragging or blockage protection</li> <li>■ Pipe filling</li> <li>■ Multi-pump control                             <ul style="list-style-type: none"> <li>■ Pump switchover</li> <li>■ Stop mode</li> <li>■ Service mode</li> <li>■ Cascade control mode</li> </ul> </li> </ul>	<ul style="list-style-type: none"> <li>■ Blockage, leakage and dry-running protection</li> <li>■ Cavitation protection</li> <li>■ Condensation protection</li> <li>■ Frost protection</li> </ul>	
<b>Fan-specific</b>		
<ul style="list-style-type: none"> <li>■ Flying restart</li> <li>■ Automatic restart</li> <li>■ Skip frequency bands</li> </ul>	<ul style="list-style-type: none"> <li>■ Fire mode (essential service mode)</li> <li>■ No load, torque and rotation (belt) monitoring with sensor</li> </ul>	
<b>Increase energy efficiency and system performance</b>		
<ul style="list-style-type: none"> <li>■ Eco mode</li> <li>■ Hibernation or sleep mode</li> </ul>	<ul style="list-style-type: none"> <li>■ Bypass mode</li> <li>■ Energy/flow calculator</li> </ul>	<ul style="list-style-type: none"> <li>■ Support to high efficiency motors (PMSM and SRM)</li> <li>■ Real time clock and programmable timer (3)</li> </ul>
<b>Optimize pump and fan operation and increase system availability</b>		
<ul style="list-style-type: none"> <li>■ Keep running mode</li> </ul>	<ul style="list-style-type: none"> <li>■ PID controller</li> </ul>	<ul style="list-style-type: none"> <li>■ Dual ramp</li> <li>■ Multi-speed setpoints</li> </ul>

### Protection functions

- Phase-loss detection for both supply and motor
- Overvoltage controller
- Undervoltage controller
- Drive overtemperature protection
- Loss of analog input signal monitoring
- External fault and warning monitoring (up to 3)
- Motor overtemperature protection (with and without sensor)
- Motor overload monitoring and protection
- Motor short-circuit and ground fault protection
- Speed and torque monitoring
- Blocking and stalling monitoring and protection
- Detection of missing communication telegrams
- Detection of communication bus interruption

## Technical data

Line voltage and output power range	
FSA...FSF	3AC 200V (-20%)...240V (+10%) 1 hp...75 hp (0.75kW...55kW)
FSA...FSG	3AC 380V (-20%)...480V (+10%) 1 hp...400 hp (0.75kW...250kW)
FSH, FSJ	3AC 380V (-15%)...480V (+10%) 400 hp...700 hp (315kW...560kW)
FSD...FSG	3AC 500V (-20%)...690V (+10%) 4 hp...250 hp (3kW...250kW)
FSH, FSJ	3AC 500V (-15%)...690V (+10%) 350 hp...700 hp (315kW...630kW)
<b>Output voltage</b>	3AC 0V...line voltage x 0.97
<b>Input frequency</b>	47 Hz...63 Hz
Output frequency	
FSA...FSG	0 Hz...550 Hz (depending upon the control mode)
FSH, FSJ	0 Hz...150 Hz (depending upon the control mode)
<b>Fundamental power factor (Cos <math>\phi</math>)</b>	0.96...0.99
<b>Efficiency class</b>	IE2 (Based on power losses according to EN 50598-2 and IEC 61800-9-2)
<b>Efficiency (<math>\eta</math>)</b>	98%
<b>Motor control</b>	<ul style="list-style-type: none"> <li>▪ V/Hz control (linear, linear with flux current control/FCC, parabolic and eco mode)</li> <li>▪ Sensorless less vector control (SLVC)</li> </ul>
<b>Supported motor types</b>	<ul style="list-style-type: none"> <li>▪ Asynchronous (induction) motor</li> <li>▪ Permanent magnet synchronous motor (PMSM)</li> <li>▪ Synchronous reluctance motor (SRM)</li> </ul>
<b>Degree of protection</b>	IP20/UL Open Type
<b>Operating temperature</b>	-4° F to 113° F (-20° C to 45° C) without derating > 113° F up to 140° F (> 45° C up to 60° C) with derating For PROFINET, EtherNet/IP™ up to 55° C (131° F) with derating
Overload	
Low Overload (LO)/Variable Torque (VT)	110% x I <sub>L</sub> for 60s
High Overload (HO)/Constant Torque (CT)	150% x I <sub>H</sub> for 60s
<b>Communication</b>	PROFINET, EtherNet/IP™, USS, Modbus RTU, BACnet MS/TP, PROFIBUS DP
<b>Functional safety</b>	Hardware-based SIL3 Safe Torque Off (STO) function with on/off switch
<b>Short-circuit current rating (SCCR)</b>	Up to 100kA according to NEW UL 61800-5-1 design
Control inputs and outputs	
6 Digital Inputs (DI 0 ... DI 5)	24V (12–30V) electrically isolated, 4mA current, PNP/NPN switchable
2 Digital (Relay) Outputs (DO 0...DO 1)	Type C, 250V AC, 2A/30V DC, 2A for resistive, inductive or capacitive load
2 Analog Inputs (AI 0...AI 1)	Differential input 0V... 10V or -10V ... +10V: typical current drain: 0.1 mA, max. voltage 35V 0/4 mA ... 20 mA: 120 $\Omega$ input resistance, voltage < 10V, current < 80 mA
1 Analog Output (AO 0)	Not isolated, switchable between voltage (0V... 10V) and current (0/4 mA ... 20 mA) via parameter setting
1 motor temperature sensor input	PTC, KTY, PT1000, bi-metallic switch with normally closed contact
1 failsafe digital input	STO—electrically isolated
1 internal aux. supply voltage	24V DC, max. 250 mA 10V DC, max. 10 mA
1 external aux. supply voltage	24V DC (20.4 ... 28.8V DC), current consumption 0.5A
1 memory card slot	For optional SD memory cards (as a backup storage device for saving of the settings after drive commissioning, and also for a series commissioning of a several identical drives via cloning of the settings)
Additional control inputs and outputs (With optional I/O Extension Module)	
2 Digital Inputs (DI 6...DI 7)	24V (12–30V) electrically isolated, 4mA current, PNP / NPN switchable
4 Digital (Relay) Outputs (DO 2...DO 5)	2x Type A and 2x Type C relay outputs rated 250V AC, 2A / 30V DC, 2A for resistive, inductive or capacitive load
1 Analog Input (AI 2)	Analog current input (0/4 mA ... 20 mA) or Temperature sensor input (Pt10000 / LG-Ni10000 / DIN-Ni1000)
1 motor temperature sensor input (AI 3)	Temperature sensor input (Sensor Pt10000 / LG-Ni10000 / DIN-Ni1000)
2 Analog Output (AO 1 ... AO 2)	Not isolated, switchable between voltage (0V... 10V) and current (0/4 mA ... 20 mA) via parameter setting
User interface	
Standard	Intelligent Operator Panel (IOP-2)—a high-resolution graphical color keypad
Optional	Smart Access Module (SAM) Part number: 6SL3255-0AA00-5AA0—a WiFi-based web server module and engineering tool for quick setup and diagnostics using a mobile device (PC, smartphone, tablet, etc.)
	Basic Operator Panel (BOP-2)—a basic keypad Blank (no Operator Panel/keypad)



## SINAMICS G120X

It's the simple, seamless and easy-to-use drive — right out of the box.



### Digitalization

Digitalization and IoT based secured health monitoring	
SINAMICS CONNECT 300 and Analyze MyDrives	<p>SINAMICS CONNECT 300 (Part number: 6SL3255-0AG30-0AA0) is the IoT gateway. It is designed to acquire data through the serial port of the SINAMICS G120X and synchronize the data to MindSphere (cloud-based open IoT operating system of Siemens) using the MindSphere application Analyze MyDrives (AMD).</p> <p>This offers users the opportunity to analyze valuable operating data gathered from the drive and enables the visualization and analysis of status information, providing users with valuable data which can be used as the basis for process optimization and maintenance strategies.</p> <p>For more information visit: <a href="http://www.siemens.com/sinamics-digitalization">www.siemens.com/sinamics-digitalization</a></p>

### Certification

Certification / marking	
	<ul style="list-style-type: none"> <li>■ cULus marking according to UL61800-5-1 and CSA C22.2 No. 274 with SCCR up to 100kA</li> <li>■ CE marking according to European Low-Voltage Directive 2014/35/EU and IEC/EN 61800-5-1, Machinery directive 2006/42/EC and IEC/EN 61800-5-2, EMC Directive 2014/30/EU and IEC/EN 61800-3, RoHS directive 2011/65/EU and EN 50581</li> <li>■ IE2 efficiency level based on power losses according to EN 50598-2 and IEC 61800-9-2</li> <li>■ Safe torque off (STO) SIL3 rating according to IEC/EN 61800-5-2</li> <li>■ EAC, K, RCM (formerly C-Tick), REACH, RoHS II, SEMI F47</li> </ul>

### Dimensions and clearance distances FSA...FSJ

Frame size	Dimensions				Max. weight of frame	
	H mm (inch)	W mm (inch)	D mm (inch)	Additional depth with Operator Panel mm (inch)	No filter kg (lbs) <sup>1</sup>	With filter kg (lbs) <sup>1</sup>
FSA	232 (9.1)	73 (2.9)	209 (8.2)	9 (0.4)	3.4 (7.5)	3.6 (8)
FSB	275 (10.8)	100 (3.9)			5.8 (12.8)	6.2 (13.7)
FSC	295 (11.6)	140 (5.5)			7.11 (15.7)	7.7 (17)
FSD	472 (18.6)	200 (7.9)	239 (9.4)	9 (0.4)	18.8 (41.5)	19.5 (43)
FSE	551 (21.7)	275 (10.8)			26.7 (59)	28.7 (63.3)
FSF	709 (27.9)	305 (12)	360 (14.2)	—	66.5 (146.6)	71 (156.53)
FSG	999.4 (39.3)	305 (12)			120 (264.6)	
FSH	1696 (66.8)	548 (21.6)	393 (15.5)	—	—	162 (357.2)
FSJ	1621 (63.8)	801 (31.5)			250 (551.16)	

<sup>1</sup>Refer to SINAMICS G120X operating instructions or rating plate information of a unit to obtain the weight specific to each rating/order number



### For additional information on SINAMICS G120X

- SINAMICS G120X Catalog: [click to download PDF](#)
- SINAMICS G120X Webpage: [www.usa.siemens.com/sinamics-g120x](http://www.usa.siemens.com/sinamics-g120x)
- For additional technical information including operating instructions please visit SINAMICS G120X Technical Reference site: <https://support.industry.siemens.com/cs/us/en/ps/25454>

## SINAMICS G120X—Selection and ordering data

Voltage class 3AC 200...240V, 47...63Hz																		
Frame size	kW (200V)	hp (240V)	Rated Output Current I <sub>L</sub> , A (240V)	Order number														
FSA	0.75	1	4.2	6	S	L	3	2	0	-	Y	C	1	0	-	U	0	
	1.1	1.5	6	6	S	L	3	2	0	-	Y	C	1	2	-	U	0	
	1.5	2	7.4	6	S	L	3	2	0	-	Y	C	1	4	-	U	0	
FSB	2	3	10.4	6	S	L	3	2	0	-	Y	C	1	6	-	U	0	
	3	4	13.6	6	S	L	3	2	0	-	Y	C	1	8	-	U	0	
	4	5.0	17.5	6	S	L	3	2	0	-	Y	C	2	0	-	U	0	
FSC	5.5	7.5	22	6	S	L	3	2	0	-	Y	C	2	2	-	U	0	
	7.5	10	28	6	S	L	3	2	0	-	Y	C	2	4	-	U	0	
FSD	11	15	42	6	S	L	3	2	0	-	Y	C	2	6	-	U	0	
	15	20	54	6	S	L	3	2	0	-	Y	C	2	8	-	U	0	
	18.5	25	68	6	S	L	3	2	0	-	Y	C	3	0	-	U	0	
FSE	22	30	80	6	S	L	3	2	0	-	Y	C	3	2	-	U	0	
	30	40	104	6	S	L	3	2	0	-	Y	C	3	4	-	U	0	
FSF	37	50	130	6	S	L	3	2	0	-	Y	C	3	6	-	U	0	
	45	60	154	6	S	L	3	2	0	-	Y	C	3	8	-	U	0	
	55	75	192	6	S	L	3	2	0	-	Y	C	4	0	-	U	0	
<b>Special coating according to IEC/EN 60721-3-3</b>																		
Class 3C2 (Standard)																	<b>2</b>	
Class 3C3*																	<b>3</b>	
<b>User interface</b>																		
Blank (No operator panel/keypad)																	<b>1</b>	
BOP-2 (Basic keypad, Class 3C3*)																	<b>2</b>	
IOP-2 (Standard—high-resolution graphical color keypad, Class 3C3*)																	<b>3</b>	
<b>I/O extension module</b>																		
without I/O extension module																	<b>0</b>	
with I/O extension module, Class 3C3*																	<b>1</b>	
<b>EMC class</b>																		
No EMI/RFI filter																	<b>U</b>	
<b>Communication interface</b>																		
PROFINET, EtherNet/IP™ (Standard)																	<b>F</b>	
USS, Modbus, RTU, BACnet MS/TP																	<b>B</b>	
PROFIBUS DP																	<b>P</b>	
*Special coating or sealing for operation in harsh/corrosive environments																		

## SINAMICS G120X—Selection and ordering data

Voltage class 3AC 380...480V, 47...63Hz																			
Frame size	kW (400V)	hp (480V)	Rated Output Current I <sub>L</sub> , A (480V)	Order number															
FSA	0.75	1	2.1	6	S	L	3	2	0	-	Y	E	1	0	-	-	-	0	
	1.1	1.5	3	6	S	L	3	2	0	-	Y	E	1	2	-	-	-	0	
	1.5	2	3.4	6	S	L	3	2	0	-	Y	E	1	4	-	-	-	0	
	2.2	3	4.8	6	S	L	3	2	0	-	Y	E	1	6	-	-	-	0	
	3	4	6.2	6	S	L	3	2	0	-	Y	E	1	8	-	-	-	0	
FSB	4	5	7.6	6	S	L	3	2	0	-	Y	E	2	0	-	-	-	0	
	5.5	7.5	11	6	S	L	3	2	0	-	Y	E	2	2	-	-	-	0	
	7.5	10	14	6	S	L	3	2	0	-	Y	E	2	4	-	-	-	0	
FSC	11	15	21	6	S	L	3	2	0	-	Y	E	2	6	-	-	-	0	
	15	20	27	6	S	L	3	2	0	-	Y	E	2	8	-	-	-	0	
FSD	18.5	25	34	6	S	L	3	2	0	-	Y	E	3	0	-	-	-	0	
	22	30	40	6	S	L	3	2	0	-	Y	E	3	2	-	-	-	0	
	30	40	52	6	S	L	3	2	0	-	Y	E	3	4	-	-	-	0	
	37	50	65	6	S	L	3	2	0	-	Y	E	3	6	-	-	-	0	
FSE	45	60	77	6	S	L	3	2	0	-	Y	E	3	8	-	-	-	0	
	55	75	96	6	S	L	3	2	0	-	Y	E	4	0	-	-	-	0	
FSF	75	100	124	6	S	L	3	2	0	-	Y	E	4	2	-	-	-	0	
	90	125	156	6	S	L	3	2	0	-	Y	E	4	4	-	-	-	0	
	110	150	180	6	S	L	3	2	0	-	Y	E	4	6	-	-	-	0	
	132	200	240	6	S	L	3	2	0	-	Y	E	4	8	-	-	-	0	
FSG	160	250	302	6	S	L	3	2	0	-	Y	E	5	0	-	-	-	0	
	200	300	361	6	S	L	3	2	0	-	Y	E	5	2	-	-	-	0	
	250	400	477	6	S	L	3	2	0	-	Y	E	5	4	-	-	-	0	
FSH	315	400	477	6	S	L	3	2	2	0	-	Y	E	5	6	-	-	C	0
	355	450	515	6	S	L	3	2	2	0	-	Y	E	5	8	-	-	C	0
	400	500	590	6	S	L	3	2	2	0	-	Y	E	6	0	-	-	C	0
FSJ	450	500	663	6	S	L	3	2	2	0	-	Y	E	6	2	-	-	C	0
	500	600	724	6	S	L	3	2	2	0	-	Y	E	6	4	-	-	C	0
	560	700	830	6	S	L	3	2	2	0	-	Y	E	6	6	-	-	C	0
<b>Special coating according to IEC/EN 60721-3-3</b>																			
Class 3C2 (Standard)													2						
Class 3C3*													3						
<b>User interface</b>																			
Blank (No operator panel/keypad)													1						
BOP-2 (Basic keypad, Class 3C3*)													2						
IOP-2 (Standard—high-resolution graphical color keypad, Class 3C3*)													3						
<b>I/O extension module</b>																			
without I/O extension module													0						
with I/O extension module, Class 3C3*													1						
<b>EMC class</b>																			
No filter (Standard—without integrated EMI/RFI filter) for FSA to FSF only													U						
Filter C2 (With integrated EMI/RFI filter Category C2) for FSA to FSG only, see Note 1													A						
Filter C3 (Standard—with integrated EMI/RFI filter Category C3) for FSG to FSJ only, see Note 1													C						
<b>Communication interface</b>																			
PROFINET, EtherNet/IP™ (Standard)													F						
USS, Modbus, RTU, BACnet MS/TP													B						
PROFIBUS DP													P						

\*Special coating or sealing for operation in harsh/corrosive environments

Note 1: For frame sizes FSG, FSH and FSJ, the filter can be deactivated by removing a grounding screw/clip for applications in an ungrounded or a high-resistance grounded or a corner-grounded supply system. Please refer to the SINAMICS G120X Operating Instructions for more information.

## SINAMICS G120X—Selection and ordering data

Voltage class 3AC 500...690V, 47...63Hz																	
Frame size	kW (690V)	hp (600V)	Rated Output Current I <sub>L</sub> , A (600V)	Order number													
FSD	3	4	5	6	S	L	3	2	0	-	Y	H	1	8	-	0	
	4	5	6.3	6	S	L	3	2	0	-	Y	H	2	0	-	0	
	5.5	7.5	9	6	S	L	3	2	0	-	Y	H	2	2	-	0	
	7.5	10	11	6	S	L	3	2	0	-	Y	H	2	4	-	0	
	11	10	14	6	S	L	3	2	0	-	Y	H	2	6	-	0	
	15	15	19	6	S	L	3	2	0	-	Y	H	2	8	-	0	
	18.5	20	23	6	S	L	3	2	0	-	Y	H	3	0	-	0	
	22	25	27	6	S	L	3	2	0	-	Y	H	3	2	-	0	
	30	30	35	6	S	L	3	2	0	-	Y	H	3	4	-	0	
FSE	37	40	42	6	S	L	3	2	0	-	Y	H	3	6	-	0	
	45	50	52	6	S	L	3	2	0	-	Y	H	3	8	-	0	
FSF	55	60	62	6	S	L	3	2	0	-	Y	H	4	0	-	0	
	75	75	80	6	S	L	3	2	0	-	Y	H	4	2	-	0	
	90	100	100	6	S	L	3	2	0	-	Y	H	4	4	-	0	
	110	125	125	6	S	L	3	2	0	-	Y	H	4	6	-	0	
FSG	132	150	144	6	S	L	3	2	0	-	Y	H	4	8	-	0	
	160	150	171	6	S	L	3	2	0	-	Y	H	5	0	-	C	
	200	200	208	6	S	L	3	2	0	-	Y	H	5	2	-	C	
	250	250	250	6	S	L	3	2	0	-	Y	H	5	4	-	C	
FSH	315	350	345	6	S	L	3	2	2	0	-	Y	H	5	6	-	C
	355	400	388	6	S	L	3	2	2	0	-	Y	H	5	8	-	C
	400	450	432	6	S	L	3	2	2	0	-	Y	H	6	0	-	C
	450	500	487	6	S	L	3	2	2	0	-	Y	H	6	2	-	C
FSJ	500	500	546	6	S	L	3	2	2	0	-	Y	H	6	4	-	C
	560	600	610	6	S	L	3	2	2	0	-	Y	H	6	6	-	C
	630	700	679	6	S	L	3	2	2	0	-	Y	H	6	8	-	C
<b>Special coating according to IEC/EN 60721-3-3</b>																	
Class 3C2 (Standard)													2				
Class 3C3*													3				
<b>User interface</b>																	
Blank (No operator panel/keypad)													1				
BOP-2 (Basic keypad, Class 3C3*)													2				
IOP-2 (Standard—high-resolution graphical color keypad, Class 3C3*)													3				
<b>I/O extension module</b>																	
without I/O extension module													0				
with I/O extension module, Class 3C3*													1				
<b>EMC class</b>																	
No filter (Standard—without integrated EMI/RFI filter) for FSD to FSF only																	U
Filter C2 (With integrated EMI/RFI filter Category C2) for FSD to FSE only																	A
Filter C3 (With integrated EMI/RFI filter Category C3) for FSF to FSJ only, standard for FSG to FSJ, see Note 1																	C
<b>Communication interface</b>																	
PROFINET, EtherNet/IP™ (Standard)																	F
USS, Modbus, RTU, BACnet MS/TP																	B
PROFIBUS DP																	P

\*Special coating or sealing for operation in harsh/corrosive environments

Note 1: For frame sizes FSG, FSH and FSJ, the filter can be deactivated by removing a grounding screw/clip for applications in an ungrounded or a high-resistance grounded or a corner-grounded supply system. Please refer to the SINAMICS G120X Operating Instructions for more information.

# SINAMICS G120X

## Push-through kits, Options and Features

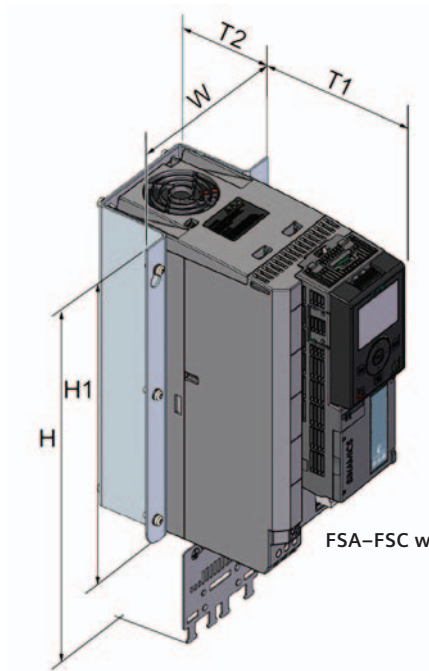

FSA-FSC with PT kit

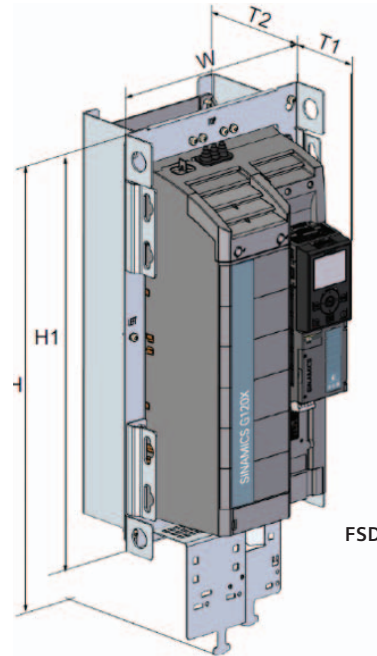

FSD-FSG with PT kit

### SINAMICS G120X IP20 Push-Through kits

SINAMICS G120X	Push-Through kit (PT)	Overall dimensions of SINAMICS G120X with PT kit installed				
		Width mm (inch)	Height mm (inch)		Depth mm (inch)	
Frame size	Part number	W	H = with shield plate	H1= without shield plate	T1 = front of PT bracket	T2 = back of PT bracket
FSA	6SL3261-6GA00-0BA0	127 (5.0)	324 (12.8)	234 (9.2)	160 (6.3)	57 (2.2)
FSB	6SL3261-6GB00-0BA0	154 (6.1)	384 (15.1)	279 (11.0)	153 (6.0)	66 (2.6)
FSC	6SL3261-6GC00-0BA0	192 (7.6)	407 (16.0)	295 (11.6)	154 (6.1)	65 (2.6)
FSD	6SL3261-6GD00-0BA0	271 (10.7)	647 (25.5)	514 (20.2)	142 (5.6)	98 (3.9)
FSE	6SL3261-6GE00-0BA0	360 (14.2)	773 (30.4)	600 (23.6)	145 (5.7)	93 (3.7)
FSF	6SL3261-6GF00-0BA0	396 (15.6)	1003 (39.5)	749 (29.5)	185 (7.3)	185 (7.3)
FSG	6SL3261-6GG00-0BA0	384 (15.1)	1275 (50.2)	1026 (40.4)	184 (7.3)	188 (7.4)

### SINAMICS G120X—options and features

Options
<ul style="list-style-type: none"> <li>■ Special coating (Class 3C3) for operation of a drive in the harsh environments where corrosive gases for example, Hydrogen Sulfide (H<sub>2</sub>S), Chlorine (Cl) or Ammonia (NH<sub>3</sub>) are often present</li> <li>■ Add-on Push-Through (PT) kit to enable UL Open Type/IP20 drive in to UL Open Type/IP20 push-through drive (up to FSG)</li> <li>■ Input and output reactors</li> <li>■ Output dv/dt filter</li> <li>■ Output Sinusoidal filter</li> <li>■ Passive line harmonic filter</li> <li>■ EMI/RFI filters</li> <li>■ Communication: PROFINET, EtherNet/IP™, USS, Modbus RTU, BACnet MS/TP and PROFIBUS DP</li> <li>■ I/O extension module</li> </ul>

